

**CyberPower®**  
Reliability. Quality. Value.

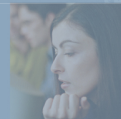

Worldwide Power Solutions



**CyberPower®**  
Reliability. Quality. Value.

**CyberPower North America**  
4241 12th Avenue East, Suite 400, Shakopee, Minnesota 55379, U.S.A.  
TEL:+1-952-403-9500 FAX:+1-952-403-0009 E-mail:sales@cyberpowersystems.com

**CyberPower Systems B.V.**  
Flight Forum 3545, 5657DW Eindhoven, The Netherlands  
TEL:+31 (0)40 2348170 FAX:+31 (0)40 2340314 E-mail:sales@cyberpower-eu.com

**CyberPower Asia Pacific**  
6F, No 32, Sec. 1, Chengong Rd, Nangang District, Taipei 115, Taiwan  
TEL:886-2-2651-8699 FAX:886-2-2651-8821 E-mail:sales@cyberpowersystems.com.tw



For more information, visit CyberPower's Web Site at [eu.cyberpowersystems.com](http://eu.cyberpowersystems.com)  
© Copyright 2008 Cyber Power Systems, Inc. All rights reserved. Product information and specification are subject to change without notice.  
All registered trademarks and trademarks contained herein are either the property of Cyber Power Systems, Inc. or of their respective holders.





**CYBERPOWER IS A WORLDWIDE  
MANUFACTURER OF POWER**

CyberPower is a worldwide manufacturer of power protection products and computer accessories. CyberPower is committed to reliability, quality and value.

Based on the premise of truly understanding consumer needs, CyberPower provides high-quality products built to exceed customer expectations. The company provides global logistics and customer service with local offices and distribution centers in North America, the European Union, Russia and Asia.

### **CyberPower Vision**

To continue to build on our reputation as a leading supplier of power protection systems and computer accessories by exceeding customer expectations in design, development, production and durability.

### **CyberPower is a True Manufacturer**

CyberPower products are manufactured in company-owned facilities located in Shenzhen, China. This allows strict control of product quality from initial concept to final design, production and distribution.

Time to market, speed to market translates to value. CyberPower does this while maintaining strict quality throughout the entire process.

*State-of-the-art Production Equipment  
Strict Component Inspection  
High Volume/Mass Production  
Quality Assurance  
ISO 9001 Certification  
TL9000 Certification  
R&D Engineering Support  
Procurement/Supplier Management*

### **Reliability, Quality, Value**

CyberPower produces the most affordable line of dependable Uninterruptible Power Supplies and offers the most feature-rich intelligent battery backup power protection units on the market today. CyberPower continuously makes feature improvements to our products to bring maximum reliability, quality, and value to the customer. CyberPower is also the industry pioneer in acquiring Microsoft certification for UPS power management software.

CyberPower's in-house expertise includes software, mechanical, electrical and firmware engineers specializing in the power protection category for more than 10 years. CyberPower brings value by continuously exceeding customer expectations in the area of product development, design and production.

CyberPower UPS - **Top #2** in N.A. Retail Market Source:NPD , 2005

CyberPower UPS Under 1KVA - **Top #4** in Global UPS sales Source:Frost & Sullivan , 2005

CyberPower DC/AC Mobile Inverter - **Top #1** in N.A. Retail Market Source:NPD , 2005

CyberPower Surge Protector - **Top #3** in N.A. Retail Market Source:NPD , 2005



## CyberPower Green Power Technology

### Save Electricity, Save Money, and help to Save the Environment !

Environment Protection, Power Consumption are very hot topics recently. The worldwide resources are limited and we have to save energy wherever we can in order to protect the environment. Additionally, the prices for energy are growing year by year and it becomes an very important economical factor in all parts of our life. For all of these reasons, CyberPower have developed the patented GreenPower UPS technology.



A traditional UPS circuit with AVR provides normal output voltage through Relay and AVR transformer. The current travels first through the transformer conducting energy and generating heat. This heat creates energy dissipation resulting in a "Power Loss" and a loss of utility power and money.

CyberPower's Green Power Circuit Design has created a solution to this "Power Loss." When the Utility Power is operating normally, our Green Power UPS works in a Bypass Mode. Our Green Power design conducts power only through the Relay and still provides normal output voltage. By saving the "Power Loss" when the current travels through the transformer, it can effectively preserve energy and cost. When the power line (Utility Power) is abnormal, the UPS will operate under Battery or AVR Mode. Under this condition, Green Power UPS and a traditional UPS would operate about the same.

On average , a UPS operates normally 88% of the time on Utility Power and the CyberPower Green Power Technology will work in its money/energy saving Bypass Mode. Take our Value2200E-GP UPS for example, and you can see that our power consumption is only 25% compared with other brand UPS. In other words, we can help you to save up to 75% electricity, heat and TCO. No matter where you are, just use our UPS to save a lot of money and help to protect our environment.

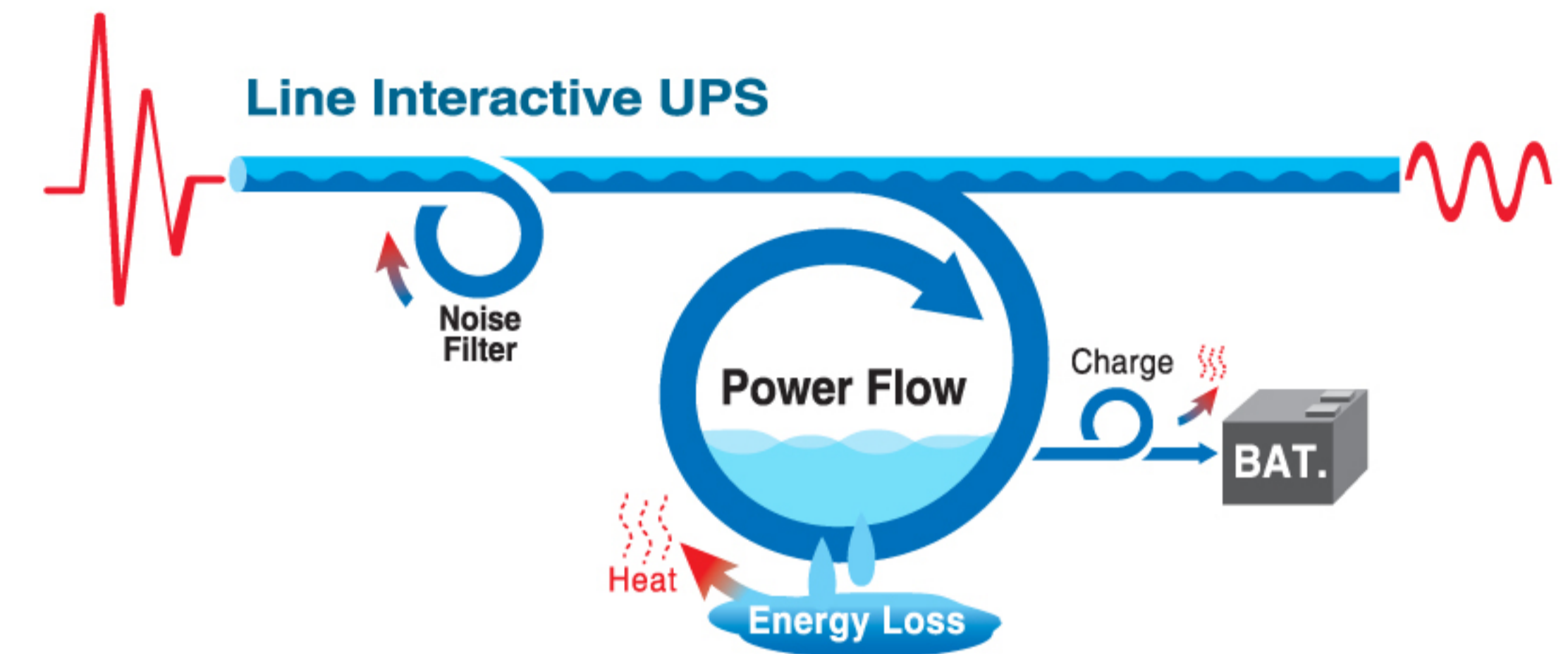
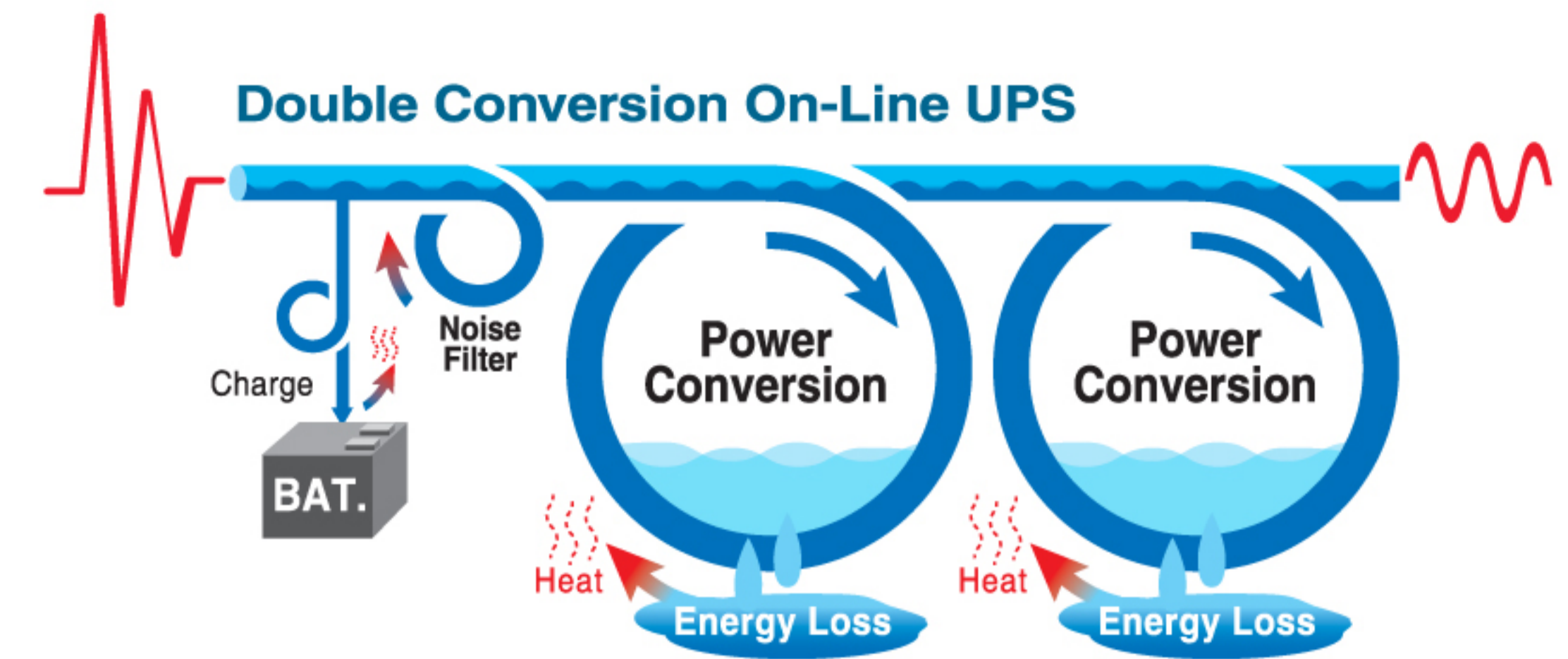
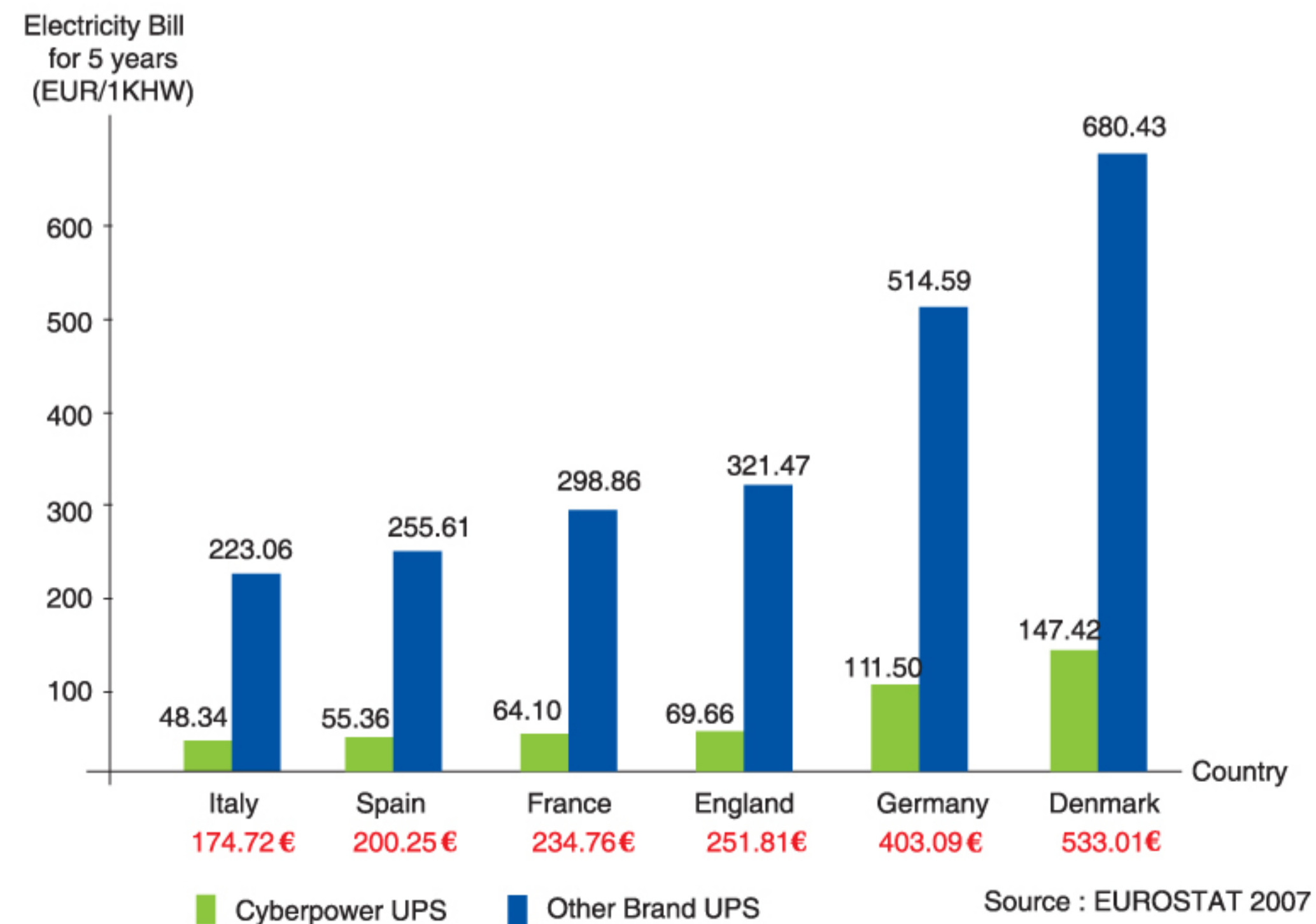
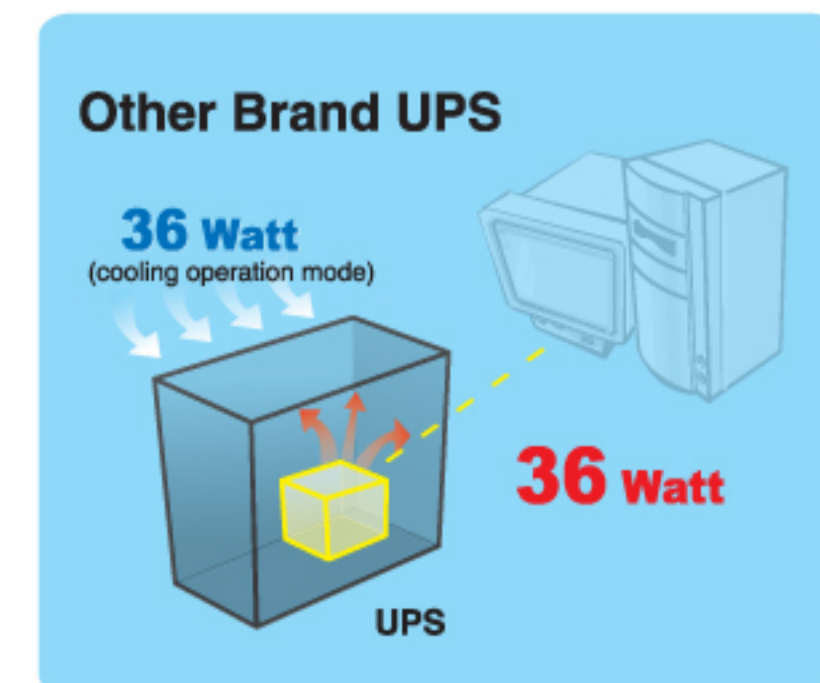
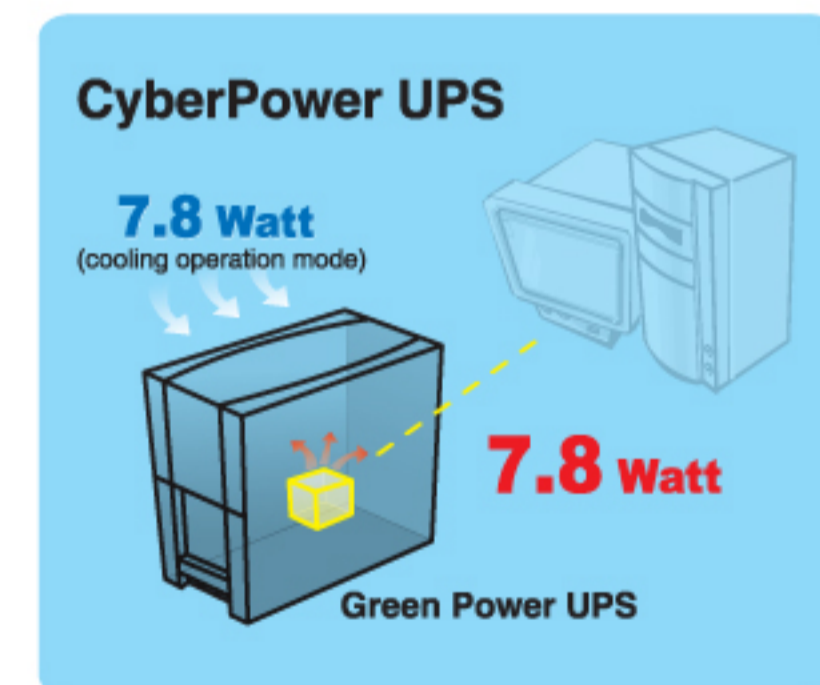

Traditional Online Double Conversion or Line Interactive UPS designs typically have as low efficiencies as around 85% under full load. Obviously, there is always a lot of Energy loss for these UPS during normal utility power operation.

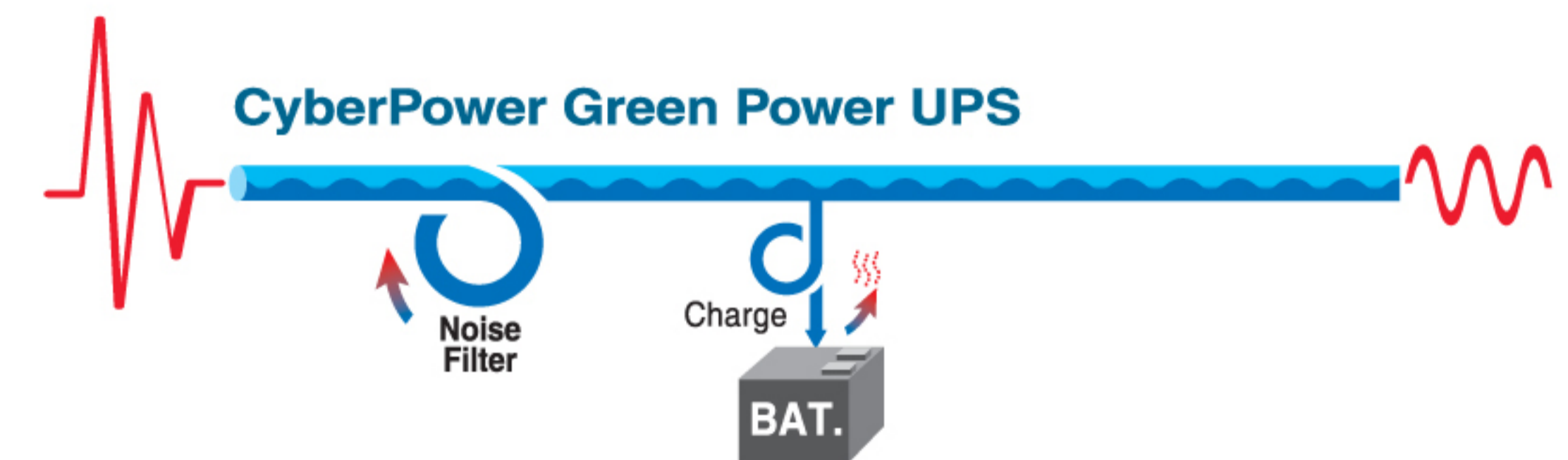

CyberPower's GreenPower UPS increases the efficiency of the UPS and saves energy during normal utility power operation.

To calculate the financial savings of the GreenPower design the following formula may be used:  
 UPS Rating x Power Factor x Average increased efficiency of a GreenPower UPS compared to a Online Double Conversion UPS or a Line Interactive UPS x working hrs/day x working days/year x utility cost in KWh x cost of cooling the heat generated under normal UPS operation

**e.g. 1(KVA) x 0.6 x 7.11% x 24hr x 365days x \$0.1<sup>(\*)</sup> x 2 = \$74.70**

\* Based on different design, the percentage of the efficiency could be various.

(\*) Utility cost in KWH will be different from contries.



## ■ UNINTERRUPTIBLE POWER SUPPLIES

Series/Applications	Home and Home Office	Small Office	Medium Business	Corporate Data Center	Networking, Servers Workstations	Industrial Equipment	GreenPower Technology		
<b>BRICs Series</b>	◆	◆					◆	01	Energy-Saving UPS
<b>BRICs LCD Series</b>	◆	◆					◆	03	Energy-Saving UPS
<b>Value Series</b>	◆	◆						05	Line Interactive UPS
<b>Value GP Series</b>	◆	◆					◆	07	Energy-Saving UPS
<b>Value GP LCD Series</b>	◆	◆	◆	◆			◆	09	Energy-Saving UPS
<b>Utility Tower Series</b>	◆	◆						11	Standby UPS
<b>Utility Tower Plus Series</b>	◆	◆						13	Standby UPS
<b>Office Tower Series</b>	◆	◆	◆	◆				15	Line Interactive UPS
<b>Office Rack Mount Series</b>			◆	◆	◆		◆	17	Energy-Saving UPS
<b>Professional Tower Series</b>			◆	◆	◆			19	Pure Sine Wave Output UPS
<b>Professional Rack Mount Series</b>			◆	◆	◆		◆	21	Pure Sine Wave Output UPS
<b>Paragon Tower Series</b>			◆	◆	◆		◆	23	On Line UPS
<b>Emergency Power System</b>	◆	◆	◆	◆	◆		◆	27	Pure Sine Wave Output UPS

## ■ TELECOMMUNICATION DC UPS

CyberShield \_\_\_\_\_ 29

## ■ UNINTERRUPTIBLE POWER SUPPLIES PERIPHERALS

CyberSwitch \_\_\_\_\_ 31

## ■ ACCESSORIES

Surge Protector \_\_\_\_\_ 33

SNMP/HTTP Network Solution \_\_\_\_\_ 34

Power Inverters \_\_\_\_\_ 35

Cables \_\_\_\_\_ 36

USB HUB \_\_\_\_\_ 37

Power Management Applications \_\_\_\_\_ 38





## UNINTERRUPTIBLE POWER SUPPLIES (UPS)

### BRICs Series

The Brics Series UPS can supply clean and stable power to protect your equipment. The included PowerPanel® Personal Edition management software showcases the feature rich abilities of this UPS such as input/output power voltage readings, self-diagnostics, scheduled shutdown, and approximate battery back-up time readings. These UPS units can be placed in either a horizontal or wallmount position to mark the most of your space. With Energy-Saving Technology, BRICs Series UPS can save upto 75% of electricity and save your electricity bill.

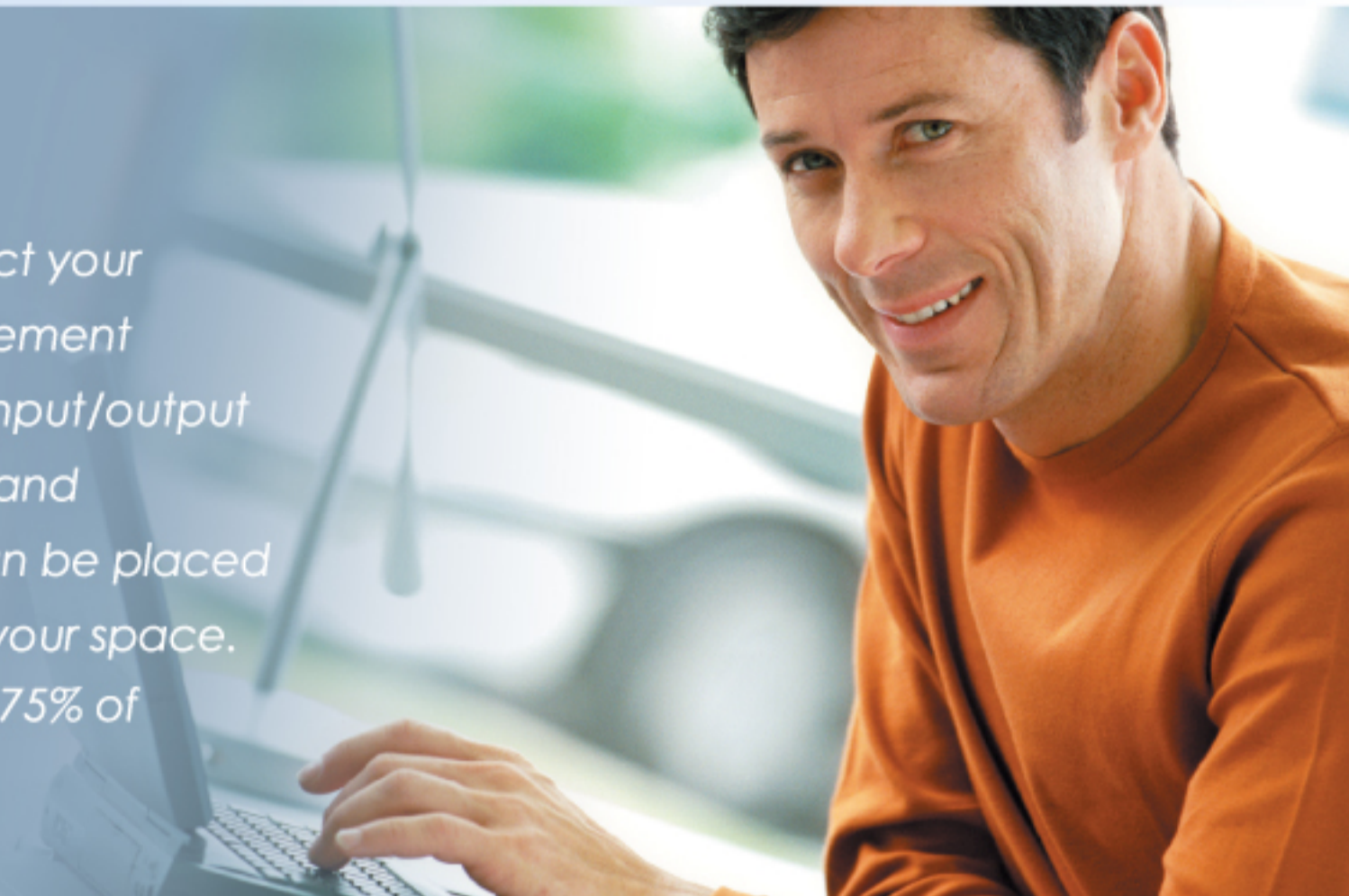

1. Power On/Off switch
2. Power On Indicator
3. Battery back-up and surge protection outlets
4. Surge protection outlet
5. Data port to PC (USB)
6. AC Input power cord
7. Input Circuit Breaker
8. Cable collector

### BR450E/BR650E/BR850E



#### PRODUCT FEATURES:

- Energy-Saving UPS
- Microprocessor based full digital control
- Automatic Voltage Regulator
- EMI, RFI, surge and lightning spike protection
- Power Management software included
- Scheduled shutdown
- Auto restart/Auto charge
- Horizontal/Wallmount use
- USB connectivity port
- Compact design with highest power output
- Green Power Technology
- Save up to 75% of Electricity
- Cable collector included

#### APPLICATIONS:

- Home and Home Office
- Small Office

#### PowerPanel® Personal Edition



CyberPower PowerPanel® Personal Edition Management Software is Compatible with Windows Vista

#### TECHNICAL SPECIFICATIONS

Model	BR450E	BR650E	BR850E
Capacity (VA)	450VA	650VA	850VA
Capacity (Watts)	270W	390W	510W
<b>Input</b>			
Input Voltage Range	160-270Vac		
Frequency Range	50/60 Hz +/-3Hz (Auto Sensing)		
<b>Output</b>			
On Battery Output Voltage	Simulated Sine Wave at 230Vac +/-10%		
On Battery Output Frequency	50/60 Hz +/-1%		
Transfer Time (Typical)	4ms		
Overload Protection	On Utility: Circuit Breaker / On Battery: Internal Current Limiting		
AVR	Boost Only		
<b>Battery</b>			
Sealed Maintenance Free Lead Acid Battery	12V / 4.5Ahx1	12V / 7Ahx1	12V / 8.5Ahx1
Typical Recharge Time	8 Hours		
<b>Transfer Time</b>			
Typical	4-6ms		
<b>Status Indicators</b>			
Indicators	Power On		
Audible Alarms	On Battery, Low Battery, Overload		
<b>Physical</b>			
Total # of UPS Receptacles	Schuko x6 (3 for Backup+Surge ,3 for Surge)		
Dimensions (mm)	271(L) x 160.7(W) x 113.6(H)		
Weight (kg)	12.7	14.0	15.1
<b>Communication</b>			
PowerPanel® Personal Edition Software	Windows 2000/NT/XP/VISTA, Mac OSX, Linux		
<b>Management</b>			
Self-Test	Manual Self-Test		
Auto-Charge	Yes		
Auto-Restart	Yes		
USB Interface	Yes		

#All specifications are subject to change without notice. © 2008 Cyber Power Systems. All Trademarks are the property of their owners.





## UNINTERRUPTIBLE POWER SUPPLIES (UPS)

### BRICs LCD Series

The Brics LCD Series UPS with LCD can supply clean and stable power to protect your equipment. The included PowerPanel® Personal Edition management software showcases the feature rich abilities of this UPS such as input/output power voltage readings, self-diagnostics, scheduled shutdown, and approximate battery back-up time readings. These UPS units can be placed in either a horizontal or wallmount position to mark the most of your space. With Energy-Saving Technology, BRICs LCD Series UPS can save upto 75% of electricity and save your electricity bill. You can easily charge AA/AAA battery Via USB charger with battery charger.



### BR450ELCD/BR650ELCD/BR850ELCD



#### PRODUCT FEATURES:

- Energy-Saving UPS
- Microprocessor based full digital control
- Automatic Voltage Regulator
- EMI, RFI, surge and lightning spike protection
- Phone/Fax/Modem/DSL/Network protection
- Power Management software included
- Scheduled shutdown
- Auto restart/Auto charge
- Horizontal/Wallmount use
- USB connectivity port
- Compact design with highest power output
- LCD Status Monitor
- Green Power Technology
- Save up to 75% of Electricity
- External AA/AAA battery charger included
- Cable collector included

#### APPLICATIONS:

- Home and Home Office
- Small Office

#### PowerPanel® Personal Edition

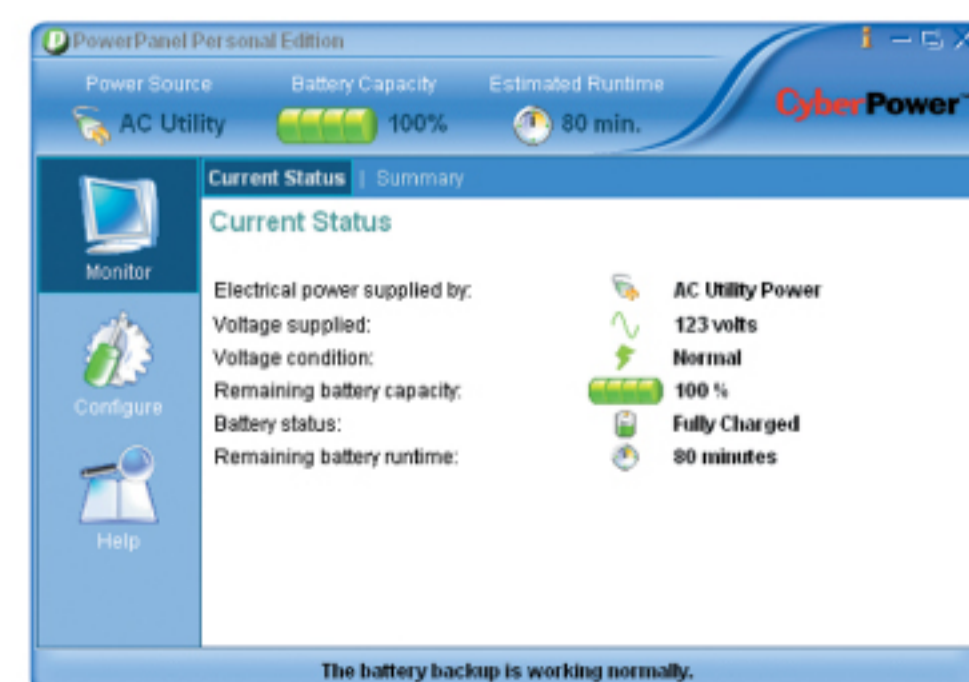

CyberPower PowerPanel® Personal Edition Management Software is Compatible with Windows Vista

### TECHNICAL SPECIFICATIONS

Model	BR450ELCD	BR650ELCD	BR850ELCD
Capacity (VA)	450VA	650VA	850VA
Capacity (Watts)	270W	390W	510W
<b>Input</b>			
Input Voltage Range	160-270Vac		
Frequency Range	50/60 Hz +/-3Hz (Auto Sensing)		
<b>Output</b>			
On Battery Output Voltage	Simulated Sine Wave at 230Vac +/-10%		
On Battery Output Frequency	50/60 Hz +/-1%		
Transfer Time (Typical)	4ms		
Overload Protection	On Utility: Circuit Breaker / On Battery: Internal Current Limiting		
AVR	Boost Only		
<b>Surge Protection</b>			
Lightning / Surge Protection	RJ11/RJ45 (One In/One Out)		
<b>Battery</b>			
Sealed Maintenance Free Lead Acid Battery	12V / 4.5Ahx1	12V / 7Ahx1	12V / 8.5Ahx1
Typical Recharge Time	8 Hours		
<b>Transfer Time</b>			
Typical	4-6ms		
<b>Status Indicators</b>			
Indicators	Power On, LED Display		
Audible Alarms	On Battery, Low Battery, Overload		
<b>Physical</b>			
Total # of UPS Receptacles	Schuko x6 (3 for Backup+Surge ,3 for Surge)		
Dimensions (mm)	271(L) x 160.7(W) x 113.6(H)		
Weight (kg)	12.7	14.0	15.1
<b>Communication</b>			
PowerPanel® Personal Edition Software	Windows 2000/NT/XP/VISTA, Mac OSX, Linux		
<b>Management</b>			
Self-Test	Manual Self-Test		
Auto-Charge	Yes		
Auto-Restart	Yes		
USB Interface	Yes		
<b>Accessories</b>			
LCD panel	Yes		
External AAA/AA battery charge, connection via USB charger	Yes		

#All specifications are subject to change without notice. © 2008 Cyber Power Systems. All Trademarks are the property of their owners.





## UNINTERRUPTIBLE POWER SUPPLIES (UPS)

### Value Series

Value Series UPS with Automatic Voltage Regulator (AVR) is the best solution for SOHO to supply a clean and stable power. Value series UPS is compatible with many different operating systems, including Microsoft Windows 98/Me/2000/NT/XP/VISTA. PowerPanel® Personal Edition management software included for USB Port shows versatility of a UPS, like power voltage, scheduled shutdown, and remaining battery capacity - remaining battery runtime - battery status ...etc. Value Series UPS is the most cost-economy and reliable UPS to bring you the best power supplies.

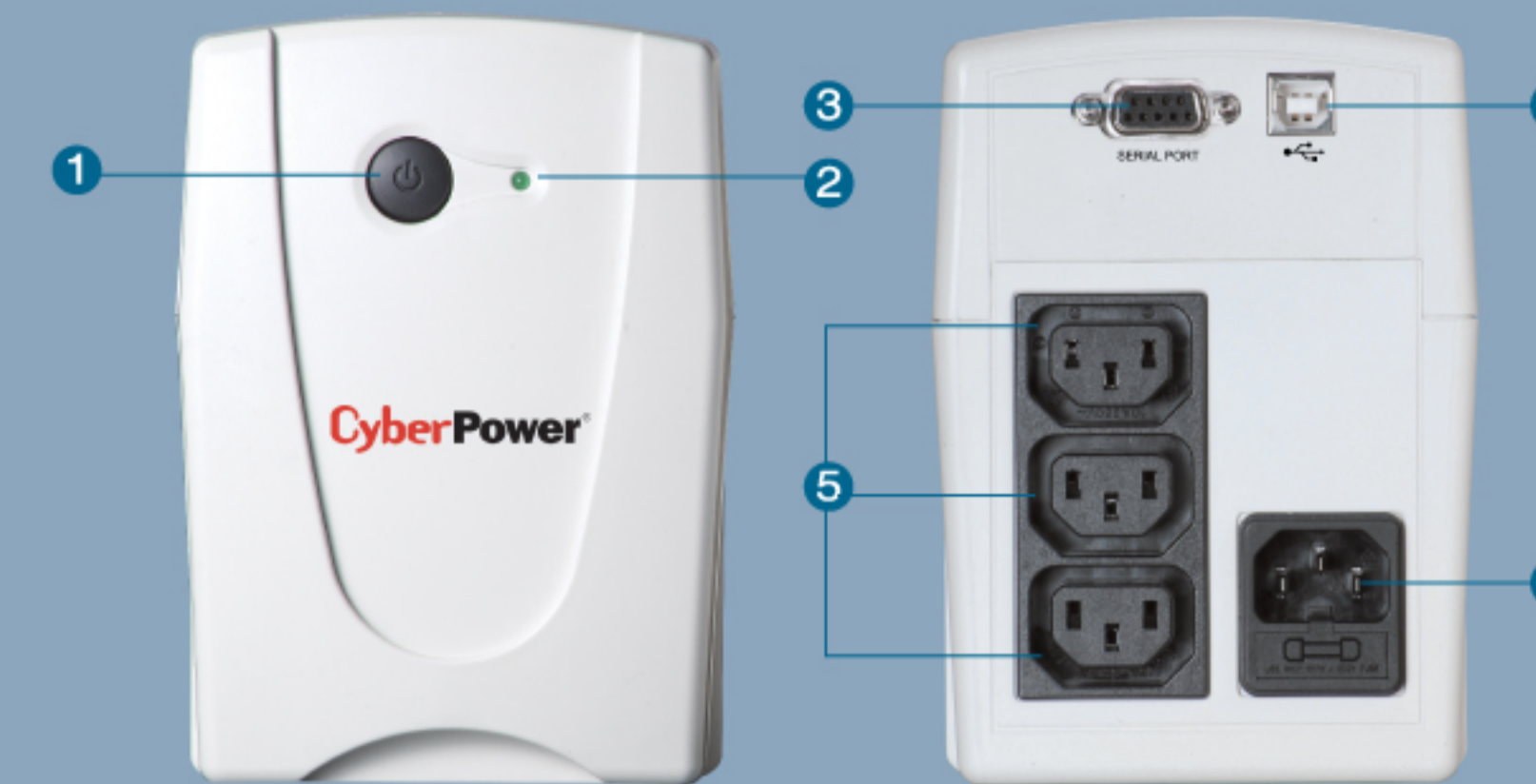

1. Power On/Off switch
2. Power On Indicator
3. Data port to PC (serial)
4. Data port to PC (USB)
5. Battery back-up
6. Utility power Input

### VALUE 400E/VALUE 600E/VALUE 800E



#### PRODUCT FEATURES:

- Line-interactive UPS
- Automatic Voltage Regulator
- Auto shutdown software
- USB & Serial connectivity ports
- Compact design with highest power output
- Auto restart/Auto charge
- Power management Software Included

#### APPLICATIONS:

- Home and Home Office
- Small Office

#### PowerPanel® Personal Edition

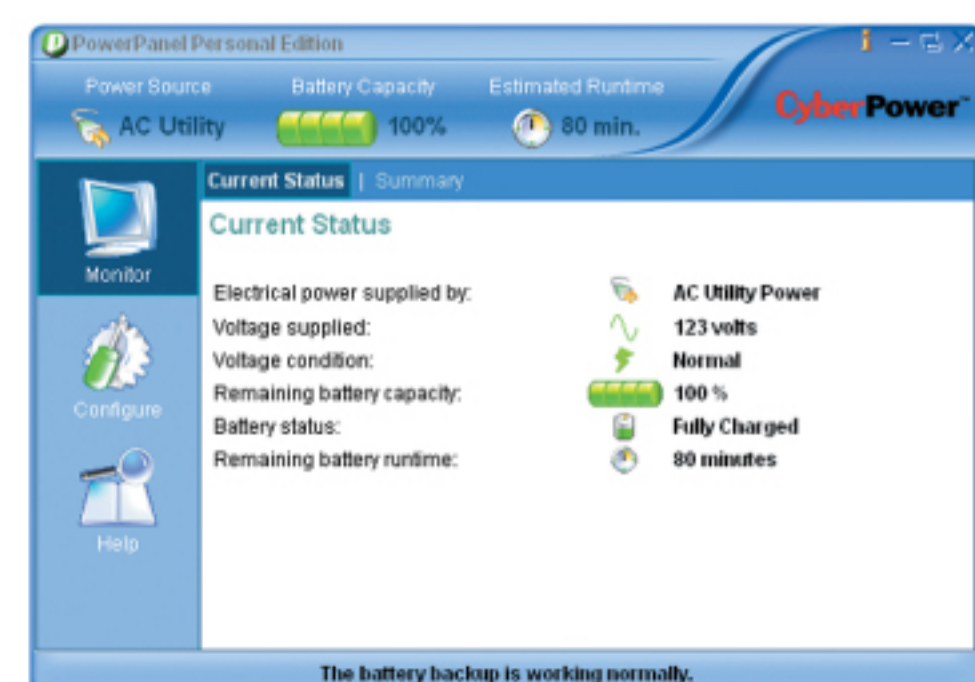

CyberPower PowerPanel® Personal Edition Management Software is Compatible with Windows Vista

### TECHNICAL SPECIFICATIONS

Model	VALUE 400E	VALUE 600E	VALUE 800E
Capacity (VA)	400VA	600VA	800VA
Capacity (Watts)	240W	360W	480W
<b>Input</b>			
Input Voltage Range	165-270Vac		
Frequency Range	45~65 Hz (Auto Sensing)		
<b>Output</b>			
On Battery Output Voltage	Simulated Sine Wave at 230Vac +/-10%		
On Battery Output Frequency	50/60 Hz		
Transfer Time (Typical)	4ms		
Overload Protection	On Utility: Fuse / On Battery: Internal Current Limiting		
AVR	Boost & Buck		
<b>Surge Protection and Filtering</b>			
Lightning/Surge Protection	Yes		
<b>Physical</b>			
Receptacles	3		
Dimensions (cm)	32.0x10.0x14.0		
Weight (kg)	4.2	5.3	6.1
<b>Battery</b>			
Sealed Maintenance Free Lead Acid Battery	12V / 4.5Ahx1	12V / 7Ahx1	12V / 9Ahx1
Typical Recharge Time	8 Hours		
<b>Warning Diagnostics</b>			
Indicators	Power On / Using Battery		
Audible Alarms	On Battery, Low Battery, Overload		
<b>Communication</b>			
PowerPanel® Personal Edition	Windows 2000/NT/XP/VISTA, Mac OSX, Linux		
<b>Management</b>			
Auto-Charge	Yes		
Auto-Restart	Yes		
USB Interface	Yes		

#All specifications are subject to change without notice. © 2008 Cyber Power Systems. All Trademarks are the property of their owners.





## UNINTERRUPTIBLE POWER SUPPLIES (UPS)

### Value GP Series

Value GP Series UPS with Automatic Voltage Regulator (AVR) is the best solution for SOHO to supply a clean and stable power. Value GP series UPS is compatible with many different operating systems, including Microsoft Windows 98/Me/2000/NT/XP/VISTA. PowerPanel® Personal Edition management software included for USB Port shows versatility of a UPS, like power voltage, scheduled shutdown, and remaining battery capacity \ remaining battery runtime \ battery status ...etc. With Energy-Saving Technology, Value GP Series UPS can save up to 75% of electricity and save your electricity bill.

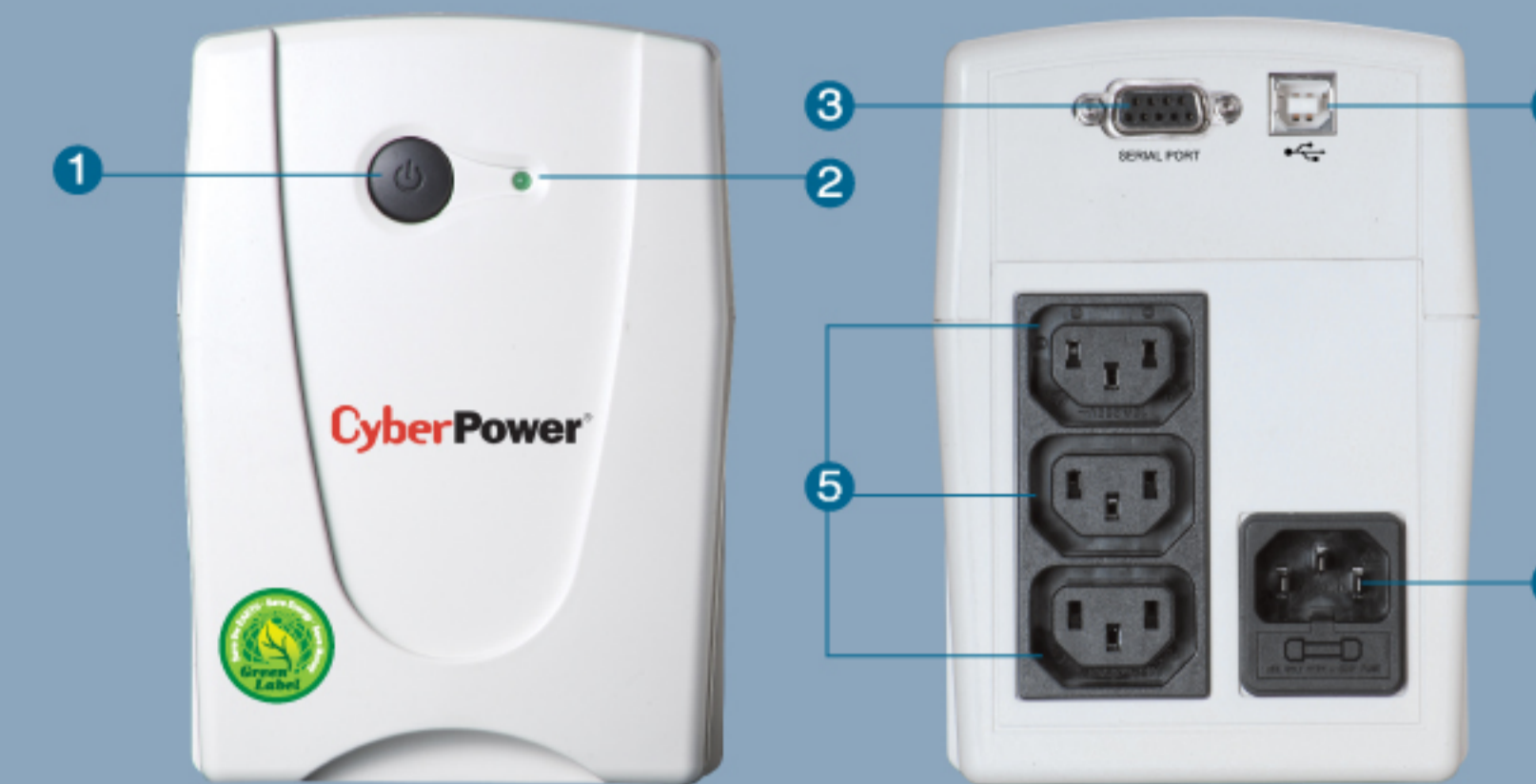

1. Power On/Off switch
2. Power On Indicator
3. Data port to PC (serial)
4. Data port to PC (USB)
5. Battery back-up
6. Utility power Input

### VALUE 400E-GP/VALUE 600E-GP/VALUE 800E-GP



#### PRODUCT FEATURES:

- Energy-Saving UPS
- Automatic Voltage Regulator
- Auto shutdown software
- USB & Serial connectivity ports
- Compact design with highest power output
- Power management Software Included
- Green Power Technology
- Auto restart/Auto charge
- Save up to 75% of Electricity

#### APPLICATIONS:

- Home and Home Office
- Small Office

#### PowerPanel® Personal Edition



CyberPower PowerPanel® Personal Edition Management Software is Compatible with Windows Vista

#### TECHNICAL SPECIFICATIONS

Model	VALUE 400E-GP	VALUE 600E-GP	VALUE 800E-GP
Capacity (VA)	400VA	600VA	800VA
Capacity (Watts)	240W	360W	480W
<b>Input</b>			
Input Voltage Range	165-270Vac		
Frequency Range	47~63 Hz (Auto Sensing)		
<b>Output</b>			
On Battery Output Voltage	Simulated Sine Wave at 230Vac +/-10%		
On Battery Output Frequency	50/60 Hz		
Transfer Time (Typical)	4ms		
Overload Protection	On Utility: Fuse / On Battery: Internal Current Limiting		
AVR	Boost Only		
<b>Surge Protection and Filtering</b>			
Lightning/Surge Protection	Yes		
<b>Physical</b>			
Receptacles	3		
Dimensions (cm)	32.0x10.0x14.0		
Weight (kg)	4.0	5.1	6.1
<b>Battery</b>			
Sealed Maintenance Free Lead Acid Battery	12V / 4.5Ahx1	12V / 7Ahx1	12V / 9Ahx1
Typical Recharge Time	8 Hours		
<b>Warning Diagnostics</b>			
Indicators	Power On / Using Battery		
Audible Alarms	On Battery, Low Battery, Overload		
<b>Communication</b>			
PowerPanel® Personal Edition	Windows 2000/NT/XP/VISTA, Mac OSX, Linux		
<b>Management</b>			
Auto-Charge	Yes		
Auto-Restart	Yes		
USB Interface	Yes		

#All specifications are subject to change without notice. © 2008 Cyber Power Systems. All Trademarks are the property of their owners.





## UNINTERRUPTIBLE POWER SUPPLIES (UPS)

### Value GP LCD Series

Value GP LCD Series UPS with Green Power Technology is the best solution to supply a clean and stable power. The art LCD panel instantly displays status of your UPS. Value GP LCD series UPS is compatible with many different operating systems, including Microsoft Windows 98/Me/2000/NT/XP/VISTA. PowerPanel® Personal Edition management software included for USB Port shows versatility of a UPS, like power voltage, scheduled shutdown, and remaining battery capacity \ remaining battery runtime \ battery status ...etc. With Energy-Saving Technology, Value GP LCD Series UPS can save upto 75% of electricity and save your electricity bill.



1. Power On/Off switch
2. LCD Display
3. Display Select
4. Data port to PC (serial)
5. Data port to PC (USB)
6. Phone/Fax/Modem/DSL network protection ports
7. Battery Back-up and Surge protection outlets
8. Circuit breaker protection
9. AC Input

### VALUE 1200E-GP/VALUE 1500E-GP/VALUE 2200E-GP



#### PRODUCT FEATURES:

- Energy-Saving UPS
- Automatic Voltage Regulator
- Auto shutdown software
- USB & Serial connectivity ports
- Power management Software Included
- Phone/Fax/Modem/DSL/Network protection
- LCD Status Monitor
- Green Power Technology
- Auto restart/Auto charge
- Save up to 75% of Electricity

#### APPLICATIONS:

- Home and Home Office
- Small Office
- Medium Business
- Corporate Data Center

#### PowerPanel® Personal Edition



CyberPower PowerPanel® Personal Edition Management Software is Compatible with Windows Vista

### TECHNICAL SPECIFICATIONS

Model	VALUE 1200E-GP	VALUE 1500E-GP	VALUE 2200E-GP
Capacity (VA)	1200VA	1500VA	2200VA
Capacity (Watts)	720W	900W	1320W
<b>Input</b>			
Input Voltage Range	160-270Vac		
Frequency Range	45~65 Hz (Auto Sensing)		
<b>Output</b>			
On Battery Output Voltage	Simulated Sine Wave at 230Vac +/-10%		
On Battery Output Frequency	50/60 Hz +/-1%		
Transfer Time (Typical)	4ms		
Overload Protection	On Utility: Fuse / On Battery: Internal Current Limiting		
AVR	Boost Only		
<b>Surge Protection and Filtering</b>			
Lightning/Surge Protection	Yes		
DSL/Phone/Fax/Modem Protection	RJ11/RJ45 (One In/One Out)		
<b>Physical</b>			
Receptacles	6		
Dimensions (cm)	32.6x14.0x18.0		
Weight (kg)	12.7	14.0	15.1
<b>Battery</b>			
Sealed Maintenance Free Lead Acid Battery	12V / 7.2Ahx2	12V / 9Ahx2	12V / 9Ahx2
Typical Recharge Time	8 Hours		
<b>Warning Diagnostics</b>			
Indicators	Power On / Using Battery		
Audible Alarms	On Battery, Low Battery, Overload		
<b>Communication</b>			
PowerPanel® Personal Edition	Windows 2000/NT/XP/VISTA, Mac OSX, Linux		
<b>Management</b>			
Auto-Charge	Yes		
Auto-Restart	Yes		
USB Interface	Yes		

#All specifications are subject to change without notice. © 2008 Cyber Power Systems. All Trademarks are the property of their owners.





## UNINTERRUPTIBLE POWER SUPPLIES (UPS)

### Utility Tower Series

Utility Tower Series UPS protects your PCs and network/phone line against surge and power cuts. It also contains PowerPanel® UPS Management software makes you easily check the UPS condition like event log and shutdown information. While power failure, a UPS will convert to battery back-up systems to provide power for your PC and ensure you have the time to save open files and shutdown safely. Utility Tower Series is the most cost-effective and stylish UPS solutions on the market.

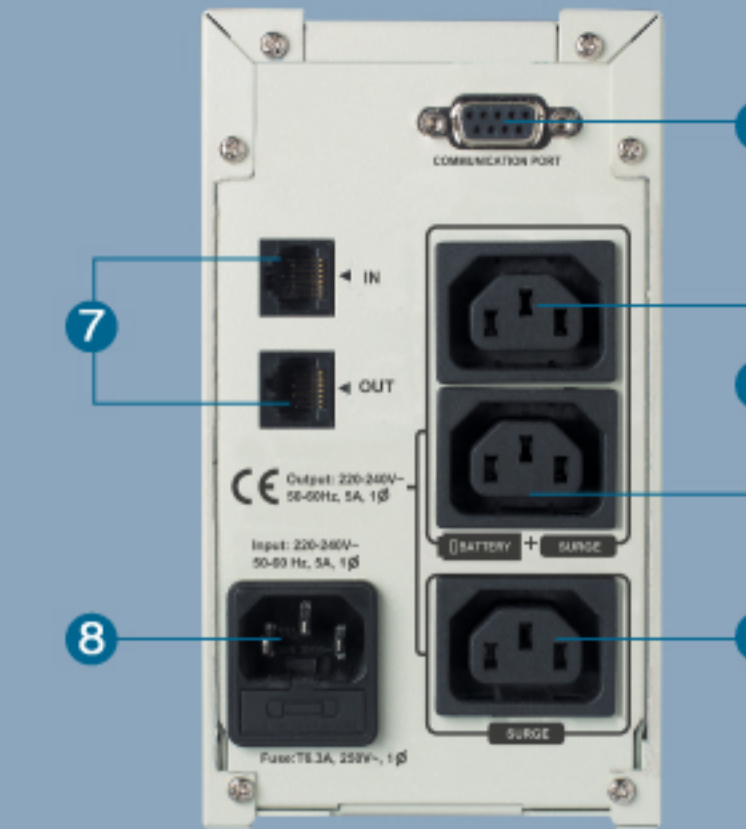
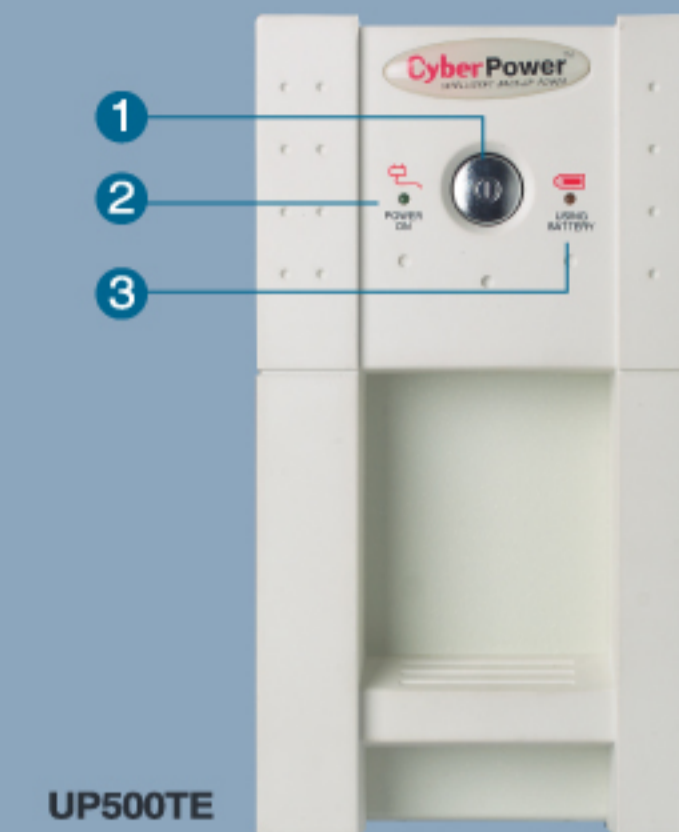

1. Power On/Off switch
2. Power On Indicator
3. Using battery Indicator
4. Battery back-up and surge protection outlets
5. Surge protection outlet
6. Data port to PC
7. Phone/Fax/Modem/Network protection ports
8. AC Input socket

### UP350TE/UP500TE/UP500E/UP750E



#### PRODUCT FEATURES:

- Standby UPS
- Microprocessor based full digital control
- EMI, RFI, surge and lightning spike protection
- Phone/Fax/Modem/DSL/Network protection
- Power Management software included
- Scheduled shutdown
- Auto restart/Auto charge
- User-replaceable batteries (only for UP500E/UP750E)
- USB cable included
- Compact design with highest power output

#### APPLICATIONS:

- Home and Home Office
- Small Office

#### PowerPanel® UPS Management

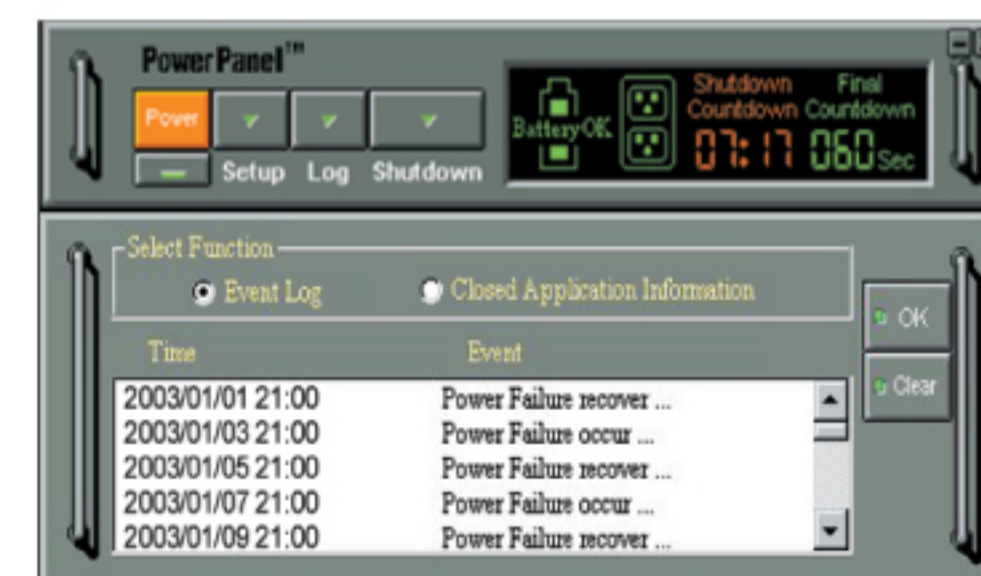

### TECHNICAL SPECIFICATIONS

Model	UP350TE	UP500TE	UP500E	UP750E
Capacity (VA/Watts)	350VA/210W	500VA/300W	500VA/325W	750VA/450W
<b>Input</b>				
Voltage Range	185Vac - 265Vac			
Frequency Range	47 - 63Hz			
<b>Output</b>				
On Battery Output Voltage	Simulated Sine Wave at 230Vac +/- 5%			
On Battery Output Frequency	50Hz/60Hz +/- 1%			
Transfer Time (Typical)	4ms			
Overload Protection	On Utility: Fuse / On Battery: Internal Current Limiting			
<b>Surge Protection and Filtering</b>				
Lightning/Surge Protection	Yes			
DSL/Phone/Fax/Modem Protection	RJ11/RJ45 (One In/One Out)			
<b>Physical</b>				
Receptacles	3		4	
Dimensions (cm)	23.8x8.0x13.7		28.3x9.1x16.4	
Weight (kg)	4.4	5.0	6.4	7.5
<b>Battery</b>				
Sealed Maintenance Free Lead Acid Battery	12V / 4AHx1	12V / 4.5AHx1	12V / 7AHx1	12V / 9AHx1
User Replaceable	No		Yes	
Typical Recharge Time	8 Hours			
<b>Status Indication</b>				
Indicators	Power On, Using Battery			
Audible Alarms	On Battery, Low Battery, Overload			
<b>Communication</b>				
PowerPanel® Software	Windows 98/ME/NT/2000/XP, Server 2003			
<b>Management</b>				
Self-Test				Yes
Auto-Charge				Yes
Auto-Restart				Yes
USB Interface				No*

\*All specifications are subject to change without notice. © 2008 Cyber Power Systems. All Trademarks are the property of their owners. \*Serial to USB conversion cable include.





## UNINTERRUPTIBLE POWER SUPPLIES (UPS)

### Utility Tower Plus Series

Utility Tower Plus Series UPS protects your PCs and network/phone line against surge and power cuts. It also contains PowerPanel® Personal Edition software makes you easily check the UPS condition like event log and shutdown information. While power failure, a UPS will convert to battery back-up systems to provide power for your PC and ensure you have the time to save open files and shutdown safely. Utility Tower Plus Series is the most cost-effective and stylish UPS with USB port on the market.

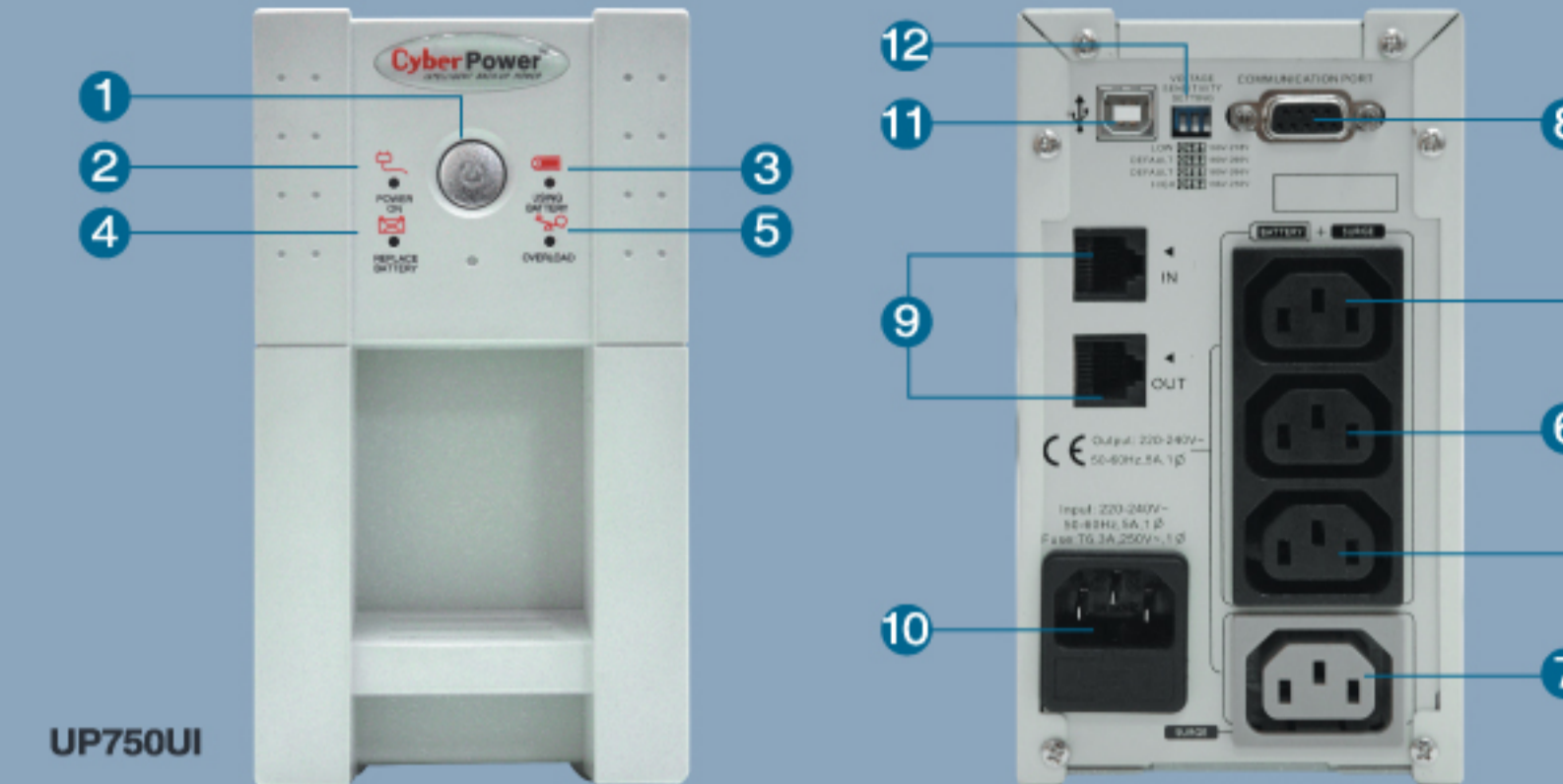

1. Power On/Off switch
2. Power On Indicator
3. Using battery Indicator
4. Replace battery Indicator
5. Overload Indicator
6. Battery back-up and surge protection outlets
7. Surge protection outlet
8. Data port to PC
9. Phone/Fax/Modem, Network protection ports
10. AC Input socket
11. USB port
12. Voltage sensitivity setting

### UP425UIT/UP550UI/UP750UI



#### PRODUCT FEATURES:

- Standby UPS
- Programmable brownout and over voltage protection
- Microprocessor based full digital control
- EMI, RFI, surge and lightning spike protection
- Phone/Fax/Modem/DSL/Network protection
- Power Management software included
- Scheduled shutdown
- Auto restart/Auto charge
- User-replaceable batteries\*
- USB Interface
- Compact design with highest power output

\*only for UP550UI / UP750UI

#### APPLICATIONS:

- Home and Home Office
- Small Office

#### PowerPanel® Personal Edition

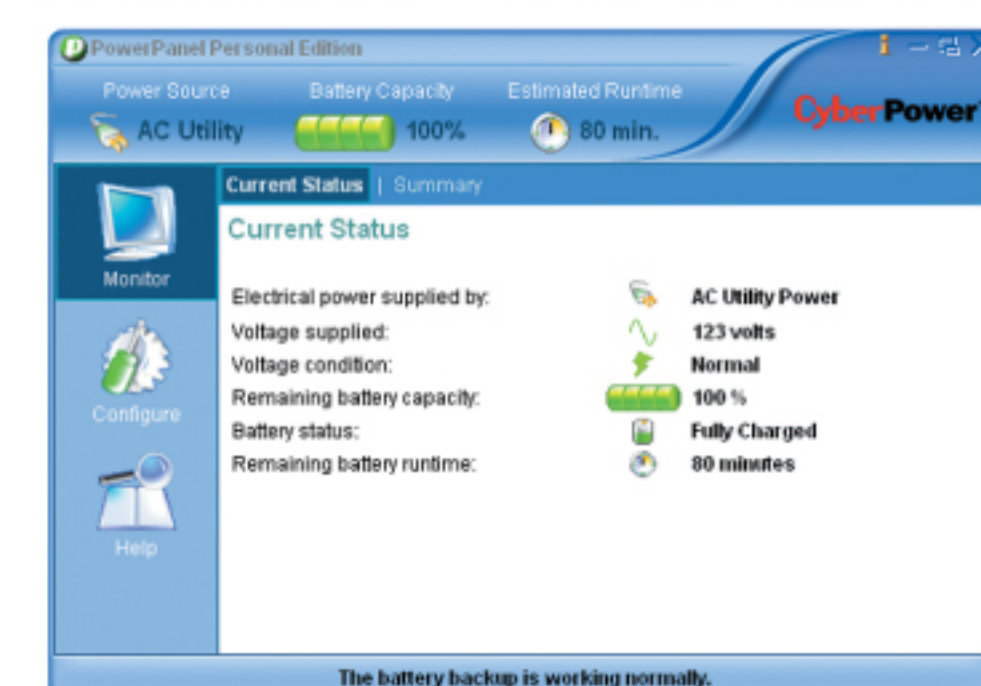

CyberPower PowerPanel® Personal Edition Management Software is Compatible with Windows Vista



### TECHNICAL SPECIFICATIONS

Model	UP425UIT	UP550UI	UP750UI
Capacity (VA/Watts)	425VA/255W	550VA/330W	750VA/450W
<b>Input</b>			
Voltage Range	160Vac - 278Vac		
Transfer Voltage Adjustment (By Software)	Line Low Limit 160Vac, Line High Limit 280Vac		
Frequency Range	47Hz - 53Hz/57Hz - 63Hz (Auto Sensing)		
<b>Output</b>			
On Battery Output Voltage	Simulated Sine Wave at 230Vac +/- 5% (220Vac, 240Vac Programmable)		
On Battery Output Frequency	50Hz/60Hz +/- 1%		
Transfer Time (Typical)	4ms		
Overload Protection	On Utility: Fuse / On Battery: Internal Current Limiting		
<b>Surge Protection and Filtering</b>			
Lightning/Surge Protection	Yes		
DSL/Phone/Fax/Modem Protection	RJ11/RJ45 (One In/One Out)		
<b>Physical</b>			
Receptacles	3	4	
Dimensions (cm)	23.8x8.0x13.7	28.3x9.1x16.4	
Weight (kg)	5	6.8	7.5
<b>Battery</b>			
Sealed Maintenance Free Lead Acid Battery	12V 4.5AHx1	12V 8AHx1	12V 9AHx1
User Replaceable	No	Yes	
Typical Recharge Time	6 Hours		
<b>Status Indication</b>			
Indicators	Power On, Using Battery, Over load, Replace battery		
Audible Alarms	On Battery, Low Battery, Overload		
<b>Communication</b>			
USB Interface	Yes		
PowerPanel® Personal Edition	Windows 2000/NT/XP, Server 2003, Mac OSX, Linux		
<b>Management</b>			
Self-Test	Yes		
Auto-Charge	Yes		
Auto-Restart	Yes		

#All specifications are subject to change without notice. © 2008 Cyber Power Systems. All Trademarks are the property of their owners.





## UNINTERRUPTIBLE POWER SUPPLIES (UPS)

### Office Tower Series

Office Tower Series UPS with Automatic Voltage Regulator (AVR) is designed for sensitive electronic equipment to supply a clean and stable power. This series UPS is compatible with any different operating systems, including Microsoft Windows Me/2000/XP/Server2003, Mac OSX, and Linux. PowerPanel Plus® UPS Management software included shows versatility of a UPS, like input/output power voltage, self-test, scheduled shutdown, and approx back-up time etc. Office Tower Series UPS is the most reliable and feature-rich UPS to bring you the best power.

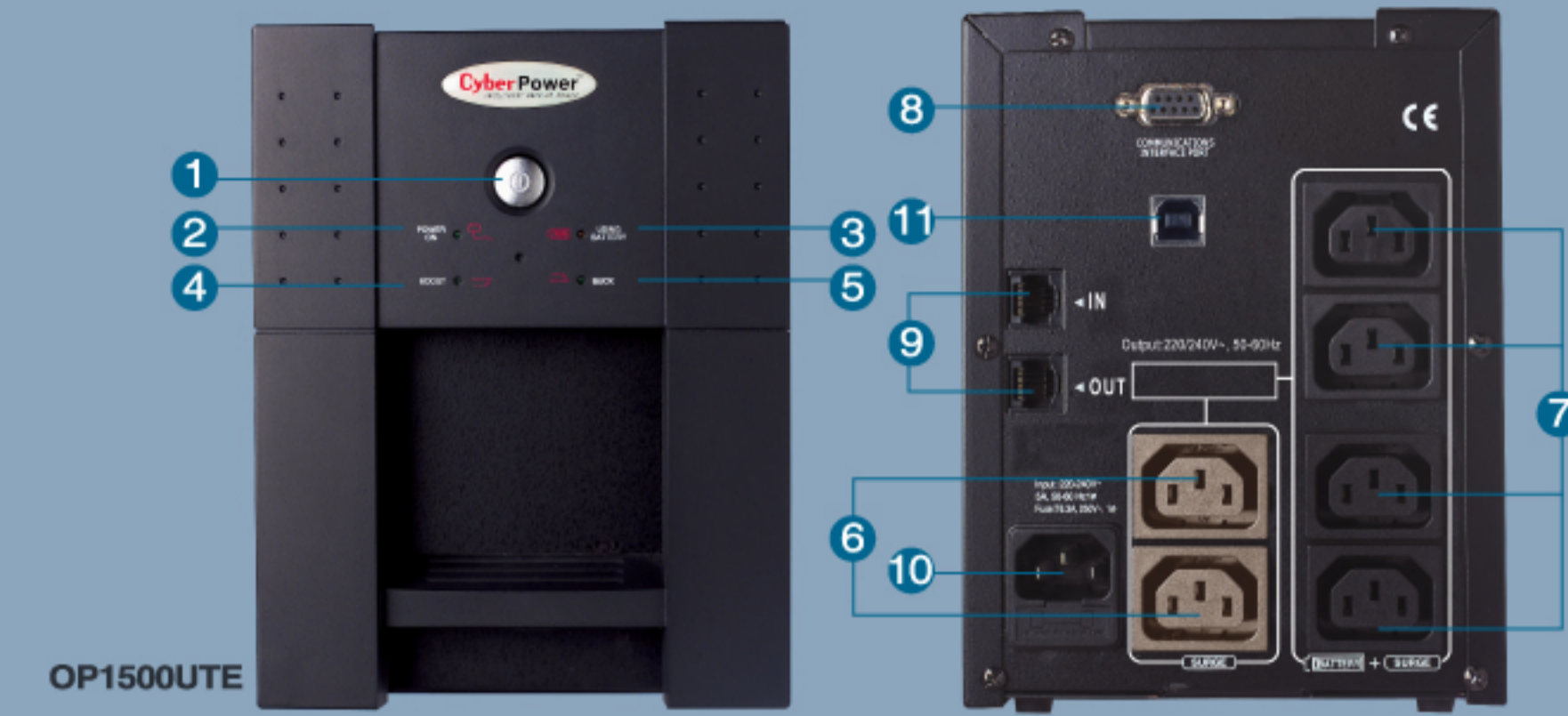

1. Power On/Off switch
2. Power On Indicator
3. Using battery Indicator
4. Boost Indicator
5. Buck Indicator
6. Surge protection outlets
7. UPS and surge protection outlets
8. Data port to PC
9. Phone/Fax/Modem/Network protection ports
10. AC Input socket
11. USB port

### OP350TE/OP500TE/OP500E/OP550E OP750E/OP1000UE/OP1500UTE



#### PRODUCT FEATURES:

- Line-Interactive UPS
- Automatic Voltage Regulator (AVR)
- Power Management software included
- Programmable brownout and over voltage protection
- Microprocessor based full digital control
- EMI, RFI, surge and lightning spike protection
- Phone/Fax/Modem/DSL/Network protection
- Scheduled shutdown
- Auto restart/Auto charge
- User-replaceable batteries\*
- USB cable included\*

\*Only for OP1000UE/OP1500UTE

#### APPLICATIONS:

- Home and Home Office
- Small Office
- Medium Business
- Corporate Data Center

#### PowerPanel Plus® UPS Management



#### TECHNICAL SPECIFICATIONS

Model	OP350TE/500TE	OP500E/550E/750E	OP1000UE/1500UTE
Capacity (VA)	350VA/500VA	500VA/550VA/750VA	1000VA/1500VA
Capacity (Watts)	200W/300W	300W/330W/450W	700W/900W
<b>Input</b>			
Voltage Range	185Vac - 270Vac		
Frequency Range	50Hz/60Hz +/- 3Hz		
<b>Output</b>			
On Battery Output Voltage	Simulated Sine Wave at 230Vac +/- 5%		
On Battery Output Frequency	50Hz/60Hz +/- 1%		
Transfer Time (Typical)	4ms		
Overload Protection	On Utility: Fuse / On Battery: Internal Current Limiting		
AVR	Boots & Buck		
<b>Surge Protection and Filtering</b>			
Lightning/Surge Protection	Yes		
DSL/Phone/Fax/Modem Protection	RJ11/RJ45 (One In / One Out)		
<b>Physical</b>			
Receptacles	3	4	6
Dimensions (cm)	23.8x8.0x13.7	28.3x9.1x16.4	30.9x14.1x18.4
Weight (kg)	4.6/5.3	6.5/6.5 / 7.6	12.3/14.2
<b>Battery</b>			
Sealed Maintenance Free Lead Acid Battery	12V 4.5AHx1/4.5AHx1	12V 7.2AHx1/7.2AHx1/9AHx1	12V 7.2AHx2/9AHx2
User Replaceable	No	Yes	
Typical Recharge Time	8 Hours		
<b>Status Indication</b>			
Indicators	Power On, Using Battery, Boost, Buck		
Audible Alarms	On Battery, Low Battery, Overload		
<b>Communication</b>			
PowerPanel Plus® Software	Windows 98/ME/NT/2000/XP, Server 2003		
<b>Management</b>			
Self-Test	No	Yes	
Auto-Charge	Yes		
Auto-Restart	Yes		
USB Interface	No*		Yes

#All specifications are subject to change without notice. © 2008 Cyber Power Systems. All Trademarks are the property of their owners.

\*Serial to USB conversion cable include.





## UNINTERRUPTIBLE POWER SUPPLIES (UPS)

### Office Rack Mount Series

Office Rack Mount Series UPS is the most high-performance UPS for servers, networking equipment, workstations and other mission-critical applications. With AVR technology stabilizing the AC input to prevent power interruption, sine-wave output provides assurance of compatibility with all types of loads. PowerPanel® Business Edition Management software is included, you can remotely monitor the UPS via an optional SNMP/HTTP card. Office Rack Mount Series UPS provides you clean and consistent power; it's the most reliable UPS to bring you the best quality power. With Energy-Saving Technology, Office Rack Mount Series UPS can save up to 75% of electricity and save your electricity bill.



1. Power On/Off switch
2. LCD Display
3. Display Select
4. Phone/Fax/Modem/DSL network protection ports
5. AC Input circuit breaker
6. Battery Back-up and Surge protection outlets
7. Surge protection outlets
8. Expansion Port
9. Communication Port to PC
10. AC Input

### OR1000ELCDRM1U/OR1500ELCDRM1U

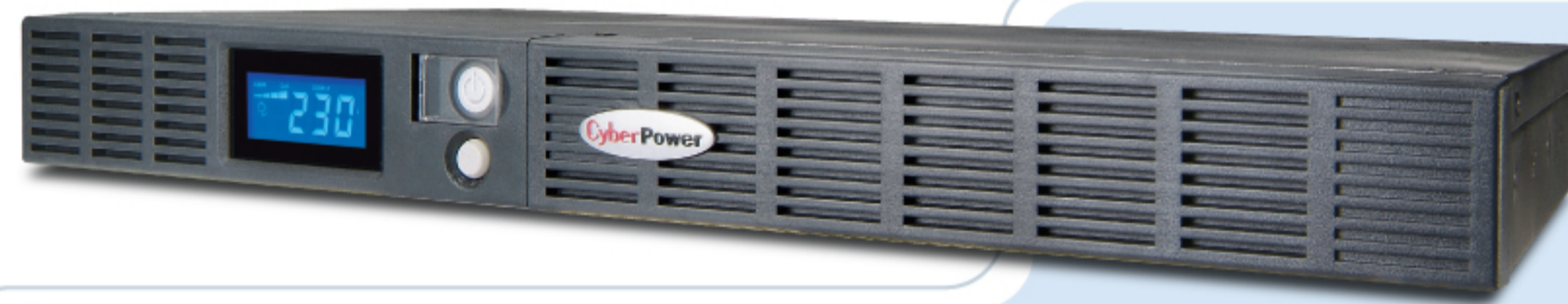

#### PRODUCT FEATURES:

- 1U rack space
- Energy-Saving UPS
- Automatic Voltage Regulator (AVR)
- Power Management software included
- Multiple outlets for multiple servers
- Multiple communication interfaces
- Programmable brownout and over voltage protection
- Microprocessor based full digital control
- EMI, RFI, surge and lightning spike protection
- Phone/Fa/Modem/DSL/Network protection
- Scheduled shutdown
- Auto restart/Auto charge
- User-replaceable batteries
- SNMP/HTTP Adapter (optional)
- LCD Status Monitor
- Green Power Technology
- Save up to 75% of Electricity

#### APPLICATIONS:

- Medium Business
- Corporate Data Center
- Networking, Servers, Workstations

#### PowerPanel® Business Edition

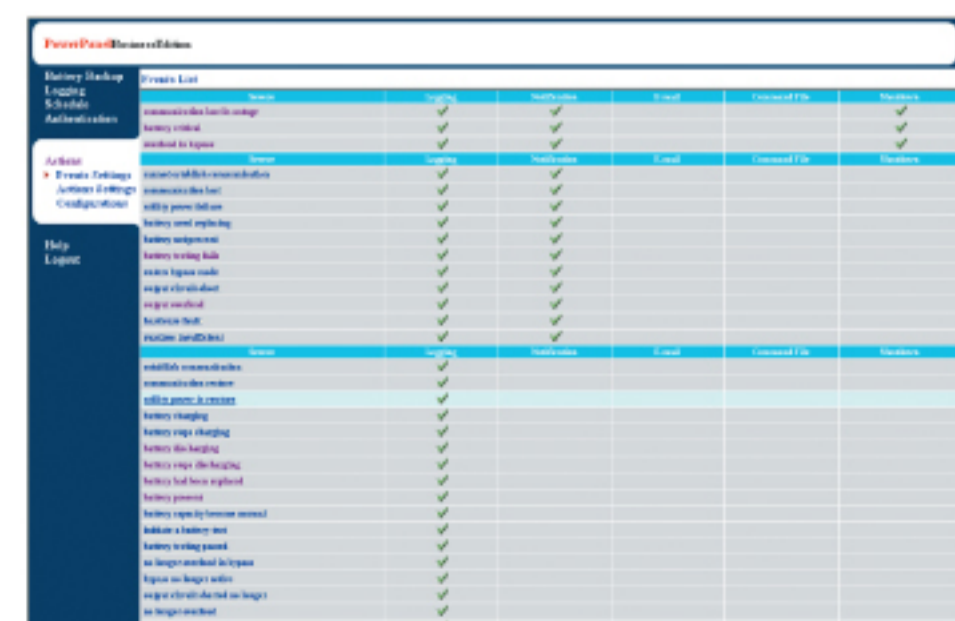

CyberPower PowerPanel® Business Edition Management Software is Compatible with Windows Vista

#### TECHNICAL SPECIFICATIONS

Model	OR1000ELCDRM1U	OR1500ELCDRM1U
Capacity (VA)	1000VA	1500VA
Capacity (Watts)	600W	900W
<b>Input</b>		
Voltage Range	160Vac - 270Vac	
Frequency Range	47Hz/63Hz	
<b>Output</b>		
On Battery Output Voltage	Simulated Sine Wave at 230Vac +/- 10%	
On Battery Output Frequency	50Hz/60Hz +/- 1%	
Transfer Time (Typical)	4ms	
Overload Protection	On Utility: Circuit Breaker / On Battery: Internal Current Limiting	
AVR	Boost Only	
<b>Surge Protection and Filtering</b>		
Lightning/Surge Protection	Yes	
DSL/Phone/Fax/Modem Protection	RJ11/RJ45 (One In/One Out)	
<b>Physical</b>		
Receptacles	IEC320 C 13x6 (Backupx4)	
Dimensions (cm)	38.9x43.3x4.4	48.5x43.3x4.4
Weight (kg)	16.1	19.4
<b>Battery</b>		
Sealed Maintenance Free Lead Acid Battery	6V / 7AHx4	6V / 9AHx4
User Replaceable	Yes	
Typical Recharge Time	8 Hours	
<b>Status Indication</b>		
Indicators	Power On, Wiring Fault, LCD Display	
Audible Alarms	On Battery, Low Battery, Overload	
<b>Communication</b>		
PowerPanel® Business Edition Software	Windows 2000/NT/XP/VISTA, Mac OSX, Linux	
<b>Management</b>		
Self-Test	Yes	
Auto-Charge	Yes	
Auto-Restart	Yes	
USB Interface	Yes	
Dry Contact Closure	Yes	
SNMP/HTTP Network	Optional	

#All specifications are subject to change without notice. © 2008 Cyber Power Systems. All Trademarks are the property of their owners.





## UNINTERRUPTIBLE POWER SUPPLIES (UPS)

### Professional Tower Series

Professional Tower Series UPS is the most high-performance UPS for servers, networking equipment, workstations and other mission-critical applications. With AVR technology stabilizing the AC input to prevent power interruption, sine-wave output provides assurance of compatibility with all types of loads. PowerPanel® Business Edition Management software is included, you can remotely monitor the UPS via an optional SNMP/HTTP card. Professional Tower Series UPS provides you clean and consistent power; it's the most reliable UPS to bring you the best quality power.



1. Power On/Off switch
2. Self-test/Silent key
3. Battery level Indicator
4. Load level Indicator
5. Using battery Indicator
6. AVR Indicator
7. Power On Indicator
8. Battery backup and surge protection outlets
9. Circuit breaker for overload protection
10. Individual backup power for critical load
11. Dual serial ports support 2 servers or computers/USB port
12. Phone/Fax/Modem/DSL network protection ports

### PP800E/PP1100E/PP1500TE PP1500E/PP2200E



#### PRODUCT FEATURES:

- Pure Sine Wave output
- Automatic Voltage Regulator (AVR)
- Power Management software included
- Multiple outlets for multiple servers
- Multiple communication interfaces
- Programmable brownout and over voltage protection
- Microprocessor based full digital control
- EMI, RFI, surge and lightning spike protection
- Phone/Fa/Modem/DSL/Network protection
- Scheduled shutdown
- Auto restart/Auto charge
- User-replaceable batteries
- USB cable included
- SNMP/HTTP card (optional for PP1500E/PP2200E)

#### APPLICATIONS:

- Medium Business
- Corporate Data Center
- Networking, Servers, Workstations
- Industrial Equipment

#### PowerPanel® Business Edition

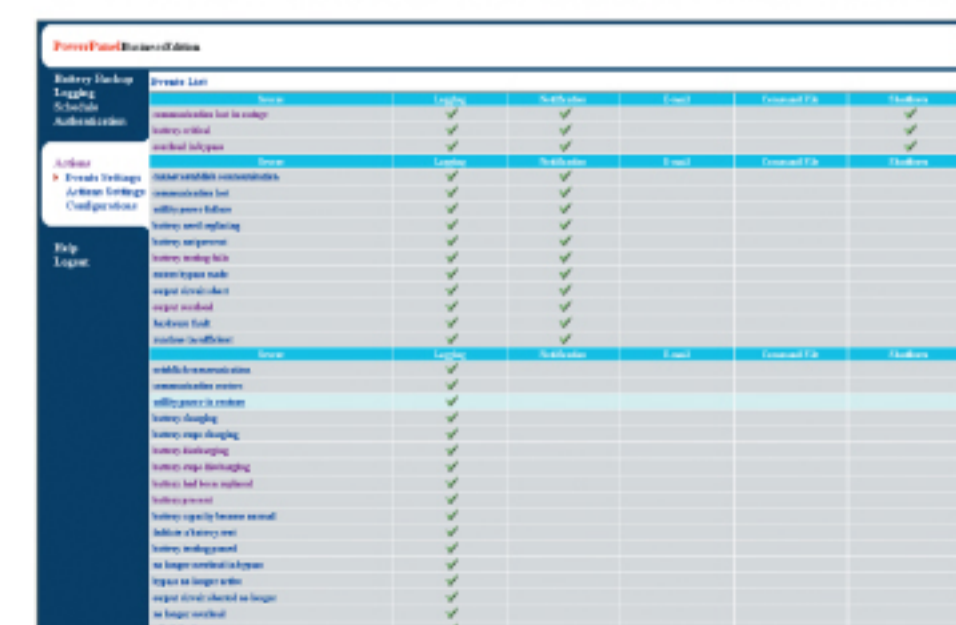

CyberPower PowerPanel® Business Edition Management Software is Compatible with Windows Vista

#### TECHNICAL SPECIFICATIONS

Model	PP800E/PP1100E/PP1500TE	PP1500E/PP2200E
Capacity (VA)	800VA/1100VA/1500VA	1500VA/2200VA
Capacity (Watts)	550W/700W/1000W	1000W/1500W
<b>Input</b>		
Voltage Range	170Vac - 280Vac	170Vac - 280Vac
Frequency Range	50Hz/60Hz +/- 3Hz	
<b>Output</b>		
On Battery Output Voltage	Pure Sine Wave at 230Vac +/- 5%	
On Battery Output Frequency	50Hz/60Hz +/- 1%	
Transfer Time (Typical)	4ms	
Overload Protection	On Utility: Fuse/Circuit Breaker / On Battery: Internal Current Limiting	
AVR	Double Boots & Single Buck	
<b>Surge Protection and Filtering</b>		
Lightning/Surge Protection	Yes	
DSL/Phone/Fax/Modem Protection	RJ11/RJ45 (One In/One Out)	
<b>Physical</b>		
Receptacles	6	8
Dimensions (cm)	30.9x14.1x18.4	42.0x18.0x23.7
Weight (kg)	12.8/14.6/15.5	25.4/31.1
<b>Battery</b>		
Sealed Maintenance Free Lead Acid Battery	12V 8AHx2/10AHx2/10AHx2	12V 7AHx4/9AHx4
User Replaceable	Yes	
Typical Recharge Time	8 Hours	
<b>Status Indication</b>		
Indicators	Power On, Using Battery, Boost, Buck, Load Level, Battery Level	
Audible Alarms	On Battery, Low Battery, Overload	
<b>Communication</b>		
PowerPanel® Business Edition	Windows 98/ME/NT/2000/XP, Server 2003	
<b>Management</b>		
Self-Test	Yes	
Auto-Charge	Yes	
Auto-Restart	Yes	
USB Interface	No*	Yes
SNMP/HTTP Network	N/A	Optional

\*All specifications are subject to change without notice. © 2008 CyberPower Systems. All Trademarks are the property of their owners.  
\*Serial to USB conversion cable include.





## UNINTERRUPTIBLE POWER SUPPLIES (UPS)

### Professional Rack Mount Series

Professional Rack Mount Series UPS is the most high-performance UPS for servers, networking equipment, workstations, industrial equipment and other mission-critical applications in rack enclosure. With AVR technology stabilizing the AC input to prevent power interruption, sine-wave output provides assurance of compatibility with all types of loads. PowerPanel® Business Edition Management software is included. You can remotely monitor the UPS via an optional SNMP/HTTP Network Solution. Professional Rack Mount Series UPS provides you clean and consistent power; it's the most reliable and professional Rack-mount UPS to bring you the best power.

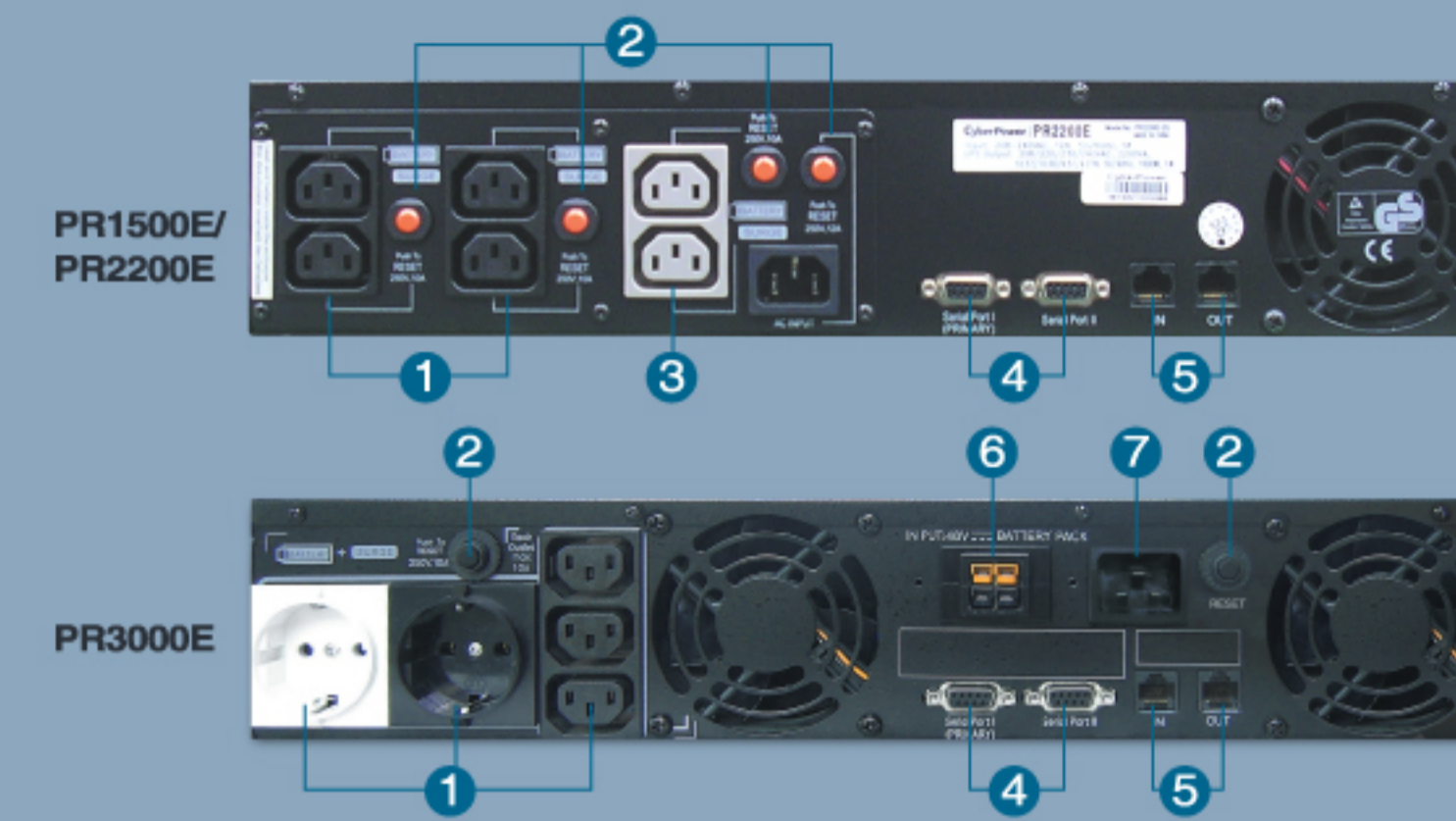

1. Battery backup and surge protection outlets
2. Circuit breaker for overload protection
3. Individual backup power for critical load
4. Data ports support 2 servers or computers
5. Phone/Fax/Modem/DSL network protection ports
6. Battery pack connector
7. Input socket



Optional Stand-Up or Rack-Mount Design

#### APPLICATIONS:

- Medium Business
- Corporate Data Center
- Networking, Servers, Workstations
- Industrial Equipment

### PR1500E/PR2200E/PR3000E

#### PRODUCT FEATURES:

- Pure Sine Wave output
- Automatic Voltage Regulator (AVR)
- Power Management software included
- Multiple outlets for multiple servers
- Multiple communication interfaces
- Programmable brownout and over voltage protection
- Microprocessor based full digital control
- EMI, RFI, surge and lightning spike protection
- Phone/Fax/Modem/DSL/Network protection
- Scheduled shutdown
- Auto restart/Auto charge
- User-replaceable batteries
- USB cable included
- SNMP/HTTP card (optional)



#### PowerPanel® Business Edition

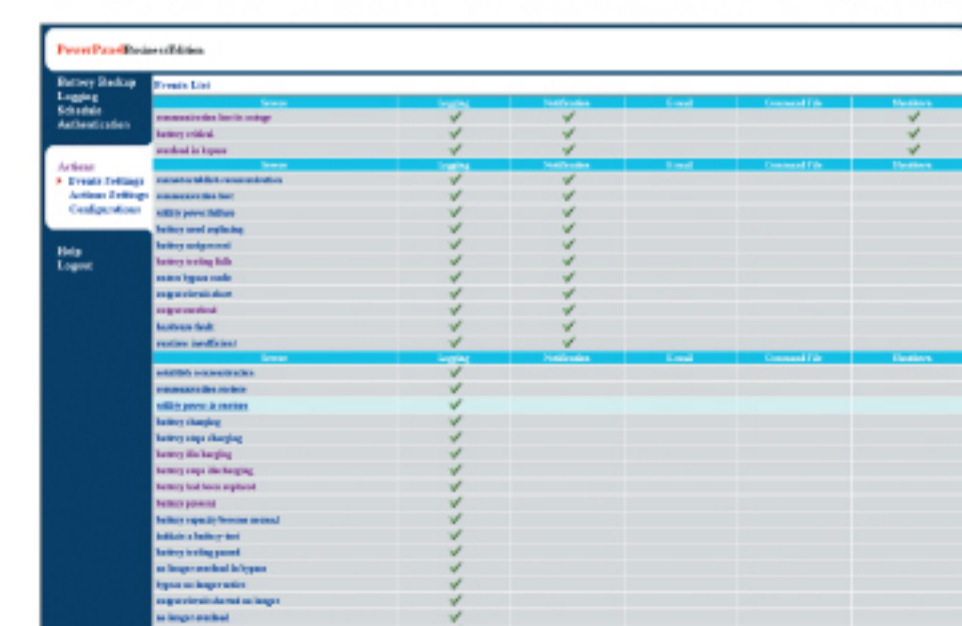

CyberPower PowerPanel® Business Edition Management Software is Compatible with Windows Vista



### TECHNICAL SPECIFICATIONS

Model	PR1500E	PR2200E	PR3000E
Capacity (VA/Watts)	1500VA/1000W	2200VA/1600W	3000VA/2200W
<b>Input</b>			
Voltage Range	170Vac - 280Vac		
Frequency Range	50Hz/60Hz +/- 3Hz		
<b>Output</b>			
On Battery Output Voltage	Pure Sine Wave at 230Vac +/- 5%		
On Battery Output Frequency	50Hz/60Hz +/- 1%		
Transfer Time (Typical)	4ms		
Overload Protection	On Utility: Circuit Breaker / On Battery: Internal Current Limiting		
AVR	Double Boots & Single Buck		
<b>Surge Protection and Filtering</b>			
Lightning/Surge Protection	Yes		
DSL/Phone/Fax/Modem Protection	RJ11/RJ45 (One In/One Out)		
<b>Physical</b>			
Receptacles	6		5
Dimensions (cm)	2U Rack, 43.3x8.8x38.8		2U Rackx2
Weight (kg)	26.4	32.1	55.5
<b>Battery</b>			
Sealed Maintenance Free Lead Acid Battery	12V / 7AHx4	12V / 9AHx4	12V / 7AHx8
User Replaceable	Yes, Hot Swappable Battery Pack		
Typical Recharge Time	8 Hours		
<b>Status Indication</b>			
Indicators	Power On, Using Battery, AVR, Load Level, Battery Level		
Audible Alarms	On Battery, Low Battery, Overload		
<b>Communication</b>			
PowerPanel® Business Edition Software	Windows 98/ME/NT/2000/XP, Server 2003		
<b>Management</b>			
Self-Test	Manual Self-Test		
Auto-Charge	Yes		
Auto-Restart	Yes		
USB Interface	No*		
SNMP/HTTP Network	Optional		

\*All specifications are subject to change without notice. © 2008 Cyber Power Systems. All Trademarks are the property of their owners.

\*Serial to USB Conversion cable include

\*TUV Only for PR2200E

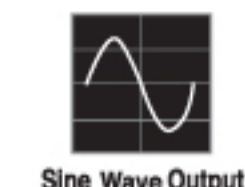



## UNINTERRUPTIBLE POWER SUPPLIES (UPS)

# Paragon Tower Series

PARAGON Series is designed for those applications requiring maximum power protection. With its double conversion design and Zero transfer time, providing nonstop clean and seamless sine wave power to the critical loads. The input and output EMI filters increase the immunity of the load to disturbances and surges, even on bypass. Through its advanced and smart communication ports, the PARAGON Series is the ideal power solution for Network, Servers, Work Station, Storage as well as industrial application protection.



OL1000TEXL/OL1000EXL-M/OL2000TEXL/OL2000EXL-M  
OL3000TEXL/OL3000EXL-M/OL6000TEXL/OL6000EXL-M  
OL10000TEXL/OL10000EXL-M



### PRODUCT FEATURES:

- Advance digital signal processing technology for 6kVA/10kVA
- Obvious LED display front panel
- Input power factor correction
- Modular design
- Efficient management charging cycle for 6kVA /10kVA
- Advanced battery management
- Extended back up time with battery pack
- Cold start function
- Auto shut down/Auto restart
- Self-diagnosis function
- Phone/Fax/Modem/DSL network protection
- PowerPanel® Business Edition Management software
- Remote monitoring (SNMP option)
- RS232 port/USB (option)/AS400 card support (option)
- Manual bypass for 6kVA/10kVA

### APPLICATIONS:

- Networking Equipments
- PCs, Servers and Work Stations
- Corporate Data Centers
- LAN File Servers
- ATM (Banking System)
- Monitoring and Security systems
- Electronic Point of Sale system
- Emergency devices (lights/alarms)
- Industrial Equipment
- Sensitive equipment requiring pure sine wave input

### PowerPanel® Business Edition

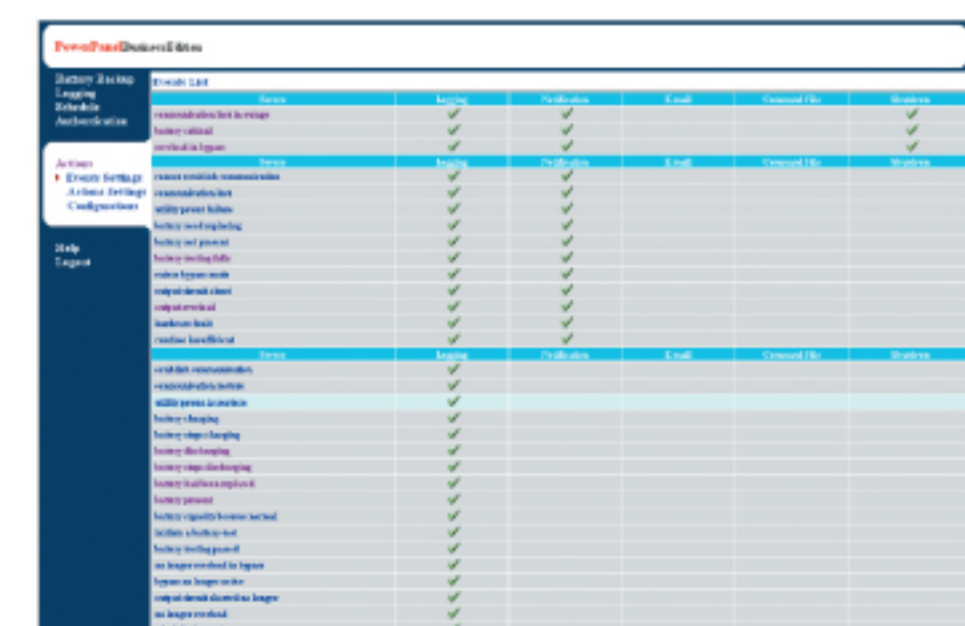

CyberPower PowerPanel® Business Edition Management Software is Compatible with Windows Vista

### FRONT PANEL LED DISPLAY:

Obvious LED visual front panel displays all major UPS status to help you quick understanding and response to your UPS. The LED Display includes Load Capacity, Battery Capacity, fault status, Bypass status, AC input...etc. Auto Shutdown and Auto Restart function can make you easily control the reliable UPS.

### SMART COMMUNICATION MANAGEMENT:

PARAGON Series offers three different communication ways for your own selection ,includes RS 232 port, RS 232 transfer to USB Adapter (option), slot for SNMP Card (option) / AS400 Card (option).You can easily monitor and manage UPS status with free PowerPanel™ Personal Edition UPS Management software and remotely monitor your UPS by AS400 Card to enhance the performance of your UPS.

### AUXILIARY BATTERY PACKS FOR EXTENDED USE:

For applications requiring prolonged battery backup times, PARAGON Series has several UPS that accommodate optional extended battery packs. Additional battery extension packs allow the standard battery runtime to be prolonged to longer back-up time.

### RELIABLE MODULE DESIGN:

PARAGON Series is the perfect modular design UPS. There are several small modular boards on the Power Board. It can facilitate your company's technicians and engineers to easily maintain and repair the UPS.

### AUTOMATIC BYPASS FUNCTION:

Ensures continuous power supply to the critical load in the event of electronic failure, overload, overheat or scheduled maintenance. PARAGON Series is able to be manual bypass and efficient management charging cycle for 6KVA/10KVA.

### OUTSTANDING INPUT POWER FACTOR CORRECTION:

Input Power factor correction with sinusoidal input to ensure a low impact on the main supply for the single-phase/single-phase series.

### LED FRONT PANEL:



### BLOCK DIAGRAM:

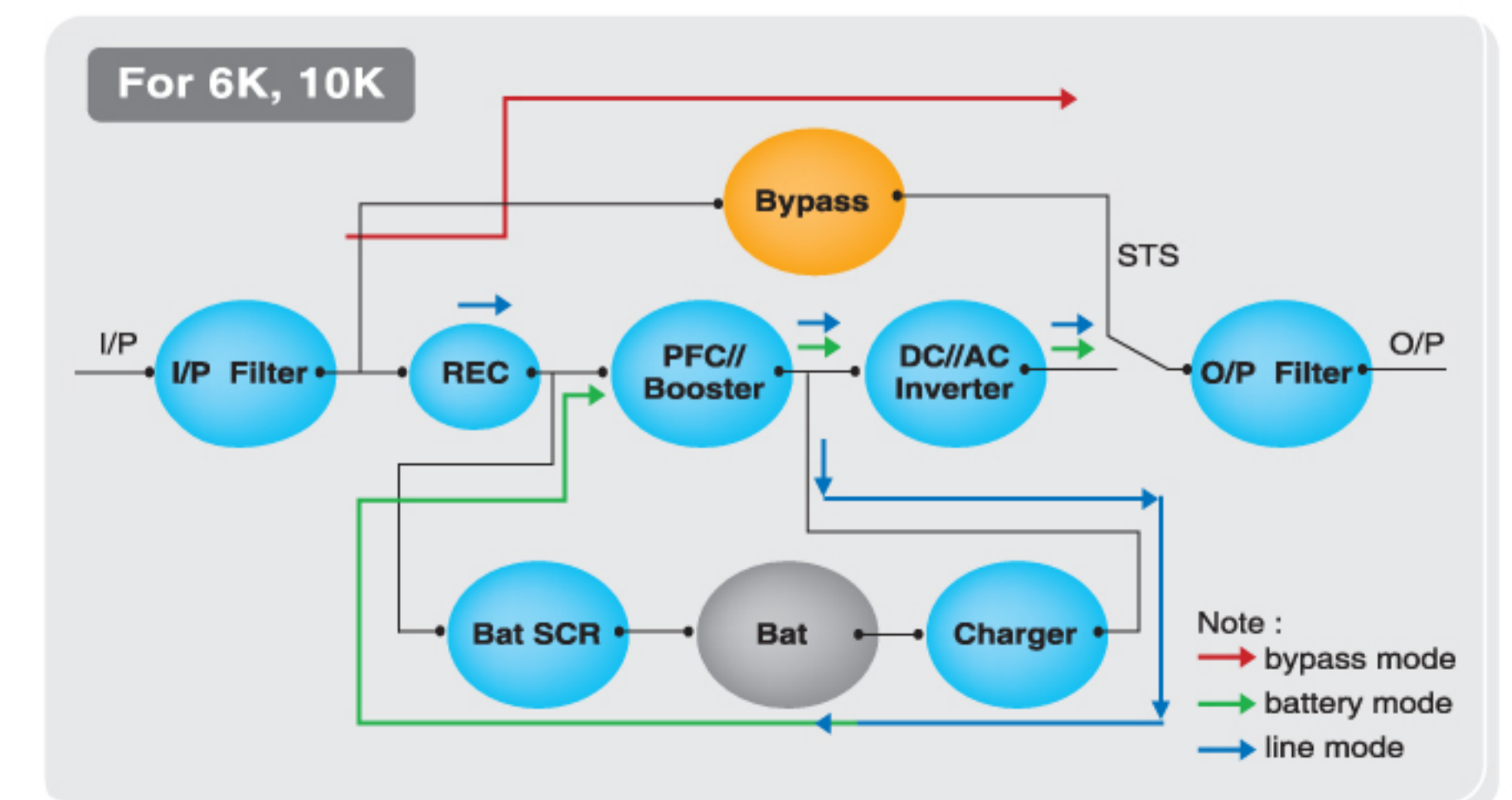
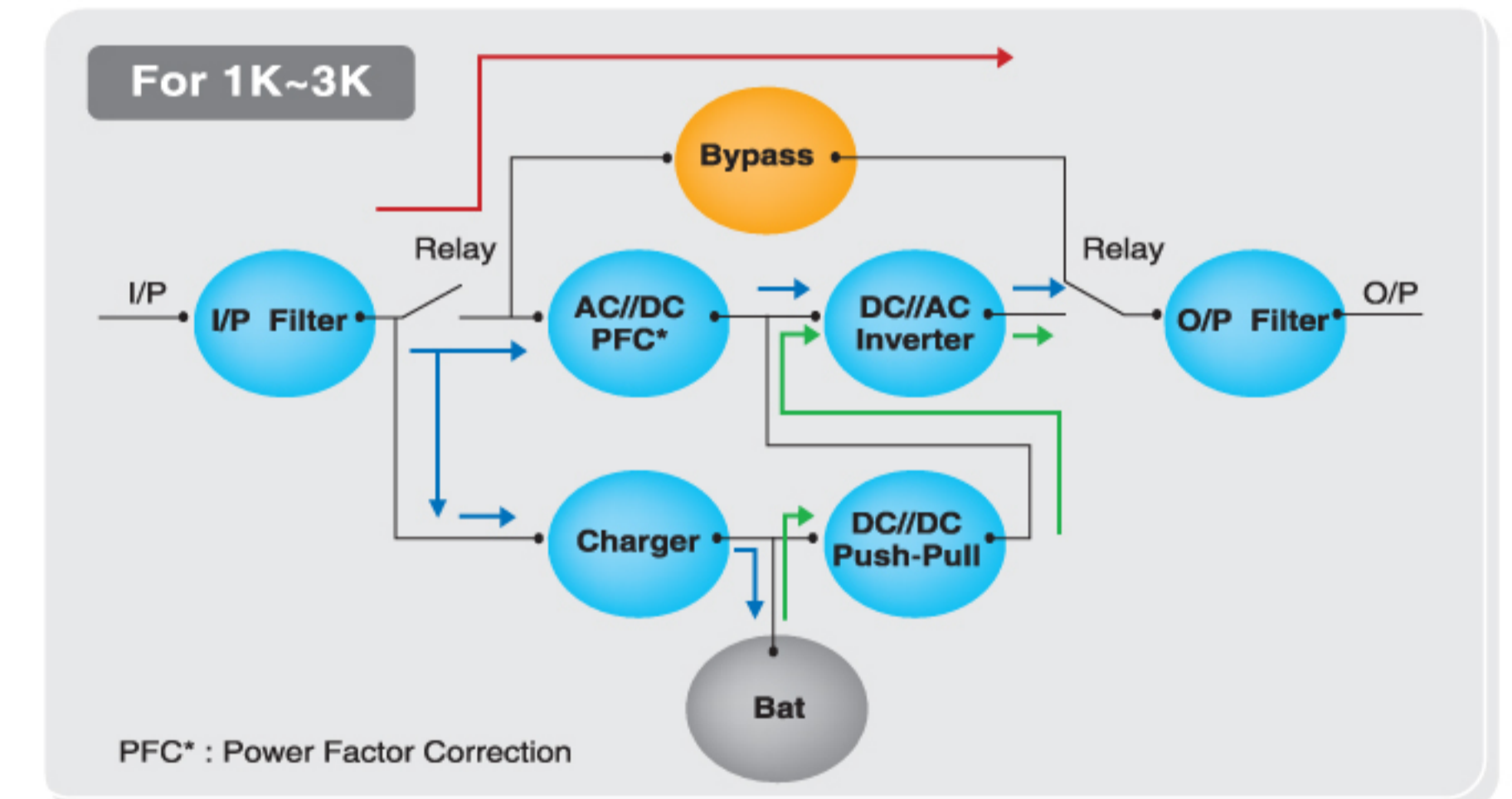



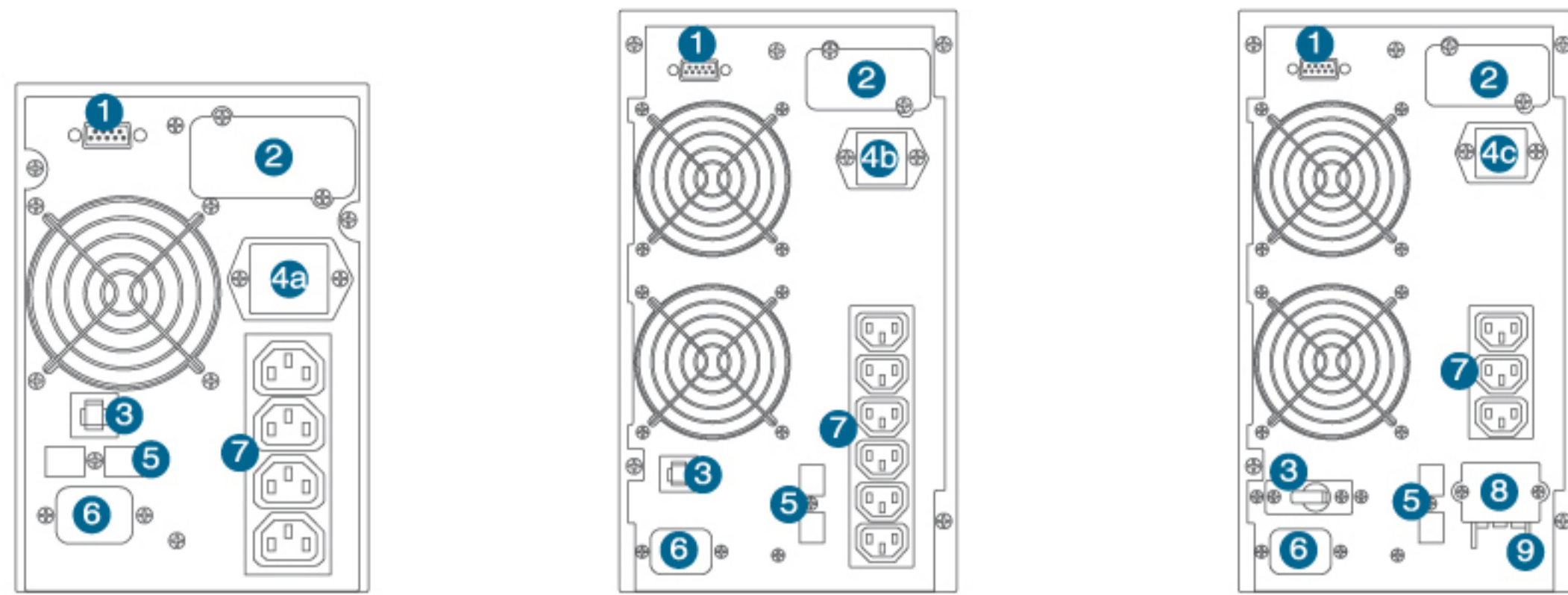

- 1 Communication port
- 2 Intelligent slot
- 3 Breaker
- 4a External battery socket
- 4b External battery socket
- 4c External battery socket
- 5 Network/Fax/Modem surge protection
- 6 Input socket
- 7 Output socket
- 8 Terminal block cover
- 9 Terminal block
- 10 Communication port
- 11 Intelligent slot
- 12 Cooling fan
- 13 Parallel port
- 14 External battery
- 15 Input breaker
- 16 Maintenance bypass switch
- 17 Terminal

**TECHNICAL SPECIFICATIONS**

Model	OL1000TEXL	OL1000EXL-M	OL2000TEXL	OL2000EXL-M	OL3000TEXL	OL3000EXL-M
Capacity (VA/W)	1000/700	1000/700	2000/1400	2000/1400	3000/2100	3000/2100
Operation Technology	True On-Line & Double Conversion					
<b>AC Input</b>						
Voltage Range	115Vac ~ 300Vac ( Based on Load Percentage )					
Frequency Range	46 Hz - 54 Hz ( 50Hz ) / 56Hz - 64Hz ( 60 Hz )					
Input Power Factor	≥0.95 @ Nominal Input Voltage and Full RCD Load					
<b>AC Output</b>						
Nominal Voltage	200/208/220/230/240 Vac					
Voltage Regulation	+/- 2%					
Voltage T.H.D	≤ 3% @ Full Linear Load ≤ 6% @ Full Non-linear Load		≤ 4% @ Full Linear Load ≤ 7% @ Full Non-linear Load			
Load Crest Factor Ratio	3:1					
Frequency Regulation	50Hz/60Hz +/- 0.2Hz (Battery Mode)					
Efficiency	85% @ AC Mode 83% @ Battery Mode		85% @ AC Mod 83% @ Battery Mode			
Over Load Capacity	108%~150%: Beep/0.5s, Fault after 30s, Auto-recovery; >150%: Fault after 300ms, Auto recovery @ 160V<Uin<286V; When Uin<160V The load will be derating. The load should be less than 80%.					
Transfer Time AC to DC	0 ms (Zero Transfer)					
Inv. to Bypass	2.5 ms ( Typical )					
Output Receptacles	(4) IEC 320 C13		(6) IEC 320 C13	(4) IEC 320 C13 + Terminal	(4) IEC 320 C13 + Terminal	
Overload Protection	Circuit Breaker					
<b>Surge Protection &amp; Filtering</b>						
Lightning/Surge Protection	Yes					
Network/Phone/Fax / Modem Surge Protection	RJ45 ( One In / One Out )					
<b>Battery</b>						
Sealed Maintenance Free Lead Acid Battery	12V / 7.2AHx3	Depending on the Capacity of external Batteries	12V / 7.2AHx8	Depending on the Capacity of external Batteries	12V / 7.2AHx8	Depending on the Capacity of external Batteries
Run Time (Full load)	>5min		>9min		>5min	
Recharging Time	5 Hours to 90%		5 Hours to 90%		5 Hours to 90%	
Charging Current (Max.)	1A	8A	1A	8A	1A	8A
<b>Agency</b>						
Safety	EN62040-1-1:2003 & IEC60950-1:2001					
EMI/RFI	EN 50091-2 Class B					
EMS	EN 61000-4-2 ESD level 4, EN 61000-4-3 RS level 3, EN 61000-4-4 EFT level 4, EN 61000-4-5 SURGE level 4 IEC 1000-2-2 LFS 10Vrms, 140 ~ 360Hz Waveform					
Immunity	EN 61000-3-2 Current Harmonic, EN 61000-3-3 Voltage Fluctuation					
<b>Environmental</b>						
Operating Temperature	0 ~ 40°C					
Relative Humidity	20 ~ 90% Non-condensing					
Altitude	5,000 ft ( 1,500m ), 0 ~ 40°C/10,000 ft ( 3,000m ), 0 ~ 35°C					
Audible Noise	< 45 dBA @1m		< 50 dBA @1m			
<b>Physical</b>						
Dimensions (cm)	14.5x40.0x22.0			19.5x45.5x33.0		
Weight (Kg)	13	7	32.2	14.5	33	16

**BATTERY PACK**

Model	ABP36VTEXL	ABP96VTEXL
Compatible	OL1000TEXL	OL2000TEXL/OL3000TEXL
Battery Voltage	36V	96V
Voltage x Rating x Quantity	12V / 7.2AHx6 ( 2 Strings of 3 in Serial )	12V / 7.2AHx16 ( 2 Strings of 8 in Serial )
Dimensions (cm)	14.5x40.0x22.0	19.5x45.5x33.0
Weight (Kg)	20.5	51

#All specifications are subject to change without notice. © 2008 Cyber Power Systems. All Trademarks are the property of their owners.

Model	OL6000TEXL	OL6000EXL-M	OL10000TEXL	OL10000EXL-M
Capacity (VA/W)	6000/4200	6000/4200	10000/7000	10000/7000
Operation Technology	True On-Line & Double Conversion			
<b>AC Input</b>				
Voltage Range	176Vac - 276Vac			
Frequency Range	46 Hz - 54 Hz ( 50Hz ) / 56Hz - 64Hz ( 60 Hz )			
Input Power Factor	≥0.97 @ Full Load			
<b>AC Output</b>				
Nominal Voltage	220/230/240 Vac			
Voltage Regulation	+/- 1%			
Voltage T.H.D	≤ 4% @ Full Linear Load / ≤ 8% @ Full Non-linear Load			
Load Crest Factor Ratio	3:1			
Frequency Regulation	50Hz/60Hz +/- 0.2Hz (Battery Mode)			
Efficiency	>85%			
Over Load Capacity	105%~130%: Transfer to bypass after 10 min., >130%: Transfer to bypass after 1s, shutdown after 1 min.			
Transfer Time AC to DC	0 ms (Zero Transfer)			
Inv. to Bypass	0 ms (Zero Transfer)			
Output Receptacles	Terminal			
Overload Protection	Circuit Breaker			
<b>Surge Protection &amp; Filtering</b>				
Lightning/Surge Protection	Yes			
Network/Phone/Fax /Modem Surge Protection	None			
<b>Battery</b>				
Sealed Maintenance Free Lead Acid Battery	12V / 7.2AHx20	Depending on the Capacity of external Batteries	12V / 9AHx20	Depending on the Capacity of external Batteries
Run Time (Full load)	>8min		>5min	
Recharging Time	7 Hours to 90%		9 Hours to 90%	
Charging Current (Max.)	1.5A	4.2A* / 3.2A**	2A	4.2A
<b>Agency</b>				
Safety	EN62040-1-1:2003 & IEC60950-1:2001			
EMI/RFI	EN50091-2 Rated Output Current Exceeding 25A Limits			
EMS	EN 61000-4-2 ESD level 4, EN 61000-4-3 RS level 3, EN 61000-4-4 EFT level 4, EN 61000-4-5 SURGE level 4 IEC 1000-2-2 LFS 10Vrms, 140 ~ 360Hz Waveform			
Immunity	EN 61000-3-2 Current Harmonic, EN 61000-3-3 Voltage Fluctuation			
<b>Environmental</b>				
Operating Temperature	0 ~ 40°C			
Relative Humidity	20 ~ 90% Non-condensing			
Altitude	5,000 ft ( 1,500m ), 0 ~ 40°C/10,000 ft ( 3,000m ), 0 ~ 35°C			
Audible Noise	< 55 dBA @1m			
<b>Physical</b>				
Dimensions (cm)	26.0x57.0x71.7			
Weight (Kg)	90	35	93	38

Model	ABP240VTEXL-6K	ABP240VTEXL-10K
Compatible	OL6000TEXL	OL10000TEXL
Battery Voltage	240V	240V
Voltage x Rating x Quantity	12V / 7.2AHx40 ( 2 Strings of 20 in Serial )	12V / 7.2AHx40 ( 2 Strings of 20 in Serial )
Dimensions (cm)	26.0x57.0x71.7	26.0x57.0x71.7
Weight (Kg)	133	133

4.2A\* ( Input Volt. 201 ~ 276Vac ) / 3.2A\*\* ( Input Volt. 176 ~ 200Vac )

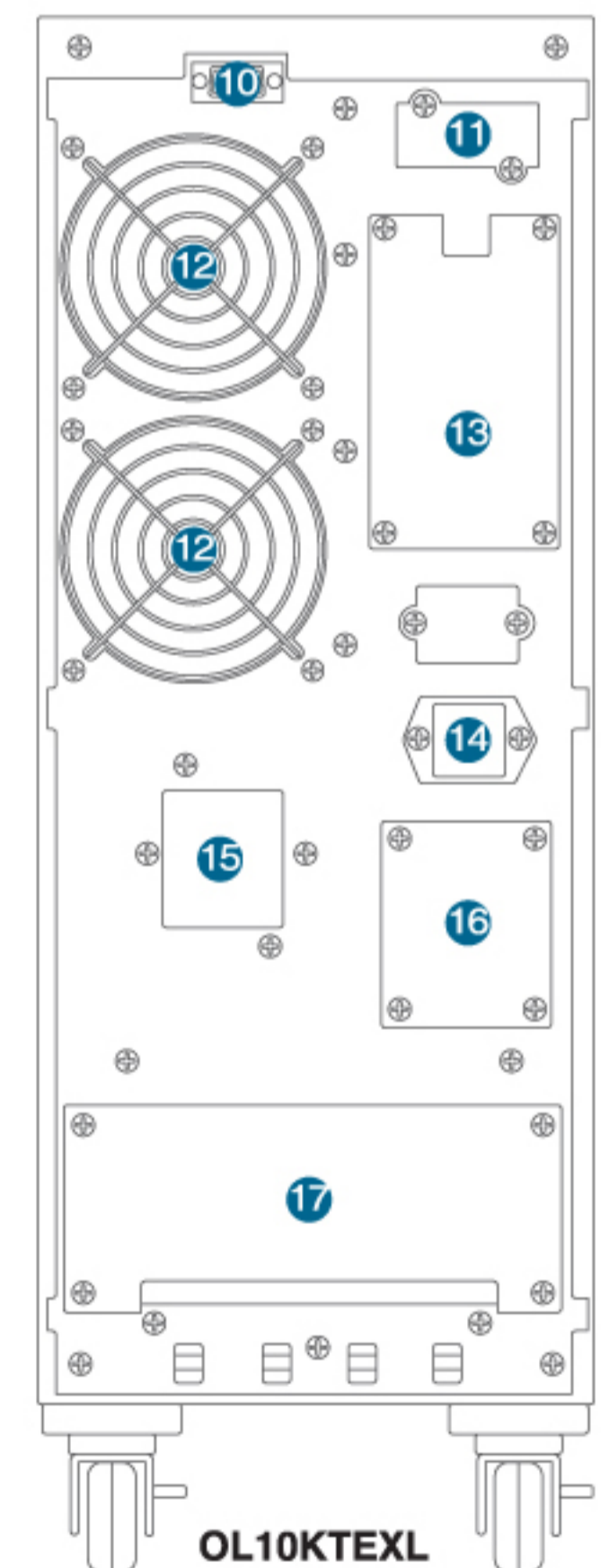
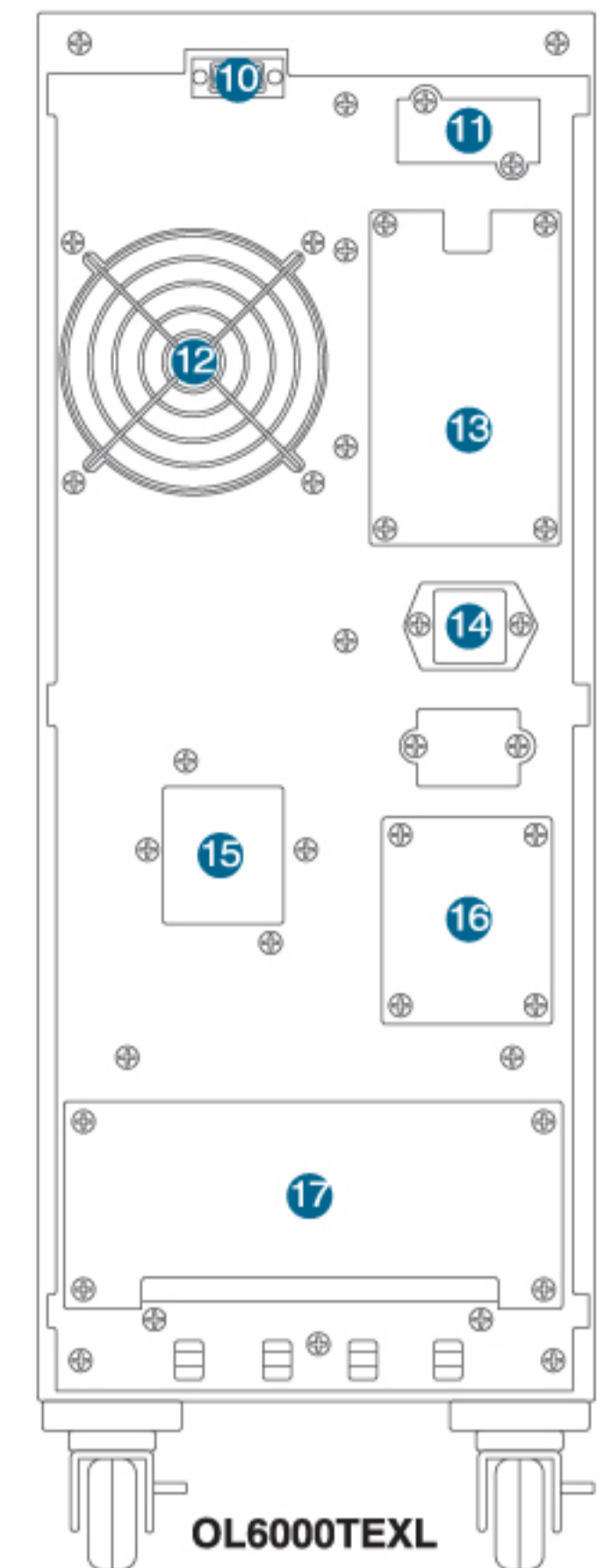



## UNINTERRUPTIBLE POWER SUPPLIES (UPS)

### Emergency Power System

CyberPower Emergency Power System (EPS) is designed and developed by state-of-the-art Microcontroller technology for lighting, generator, heater, refrigerator, motors, and other apparatus to provide resources in a crisis or when regular systems fail.

Pure Sine Wave Output with the adjustable AVR feature is highly suitable for all kinds of power environment to supply energy to various loads. Decent enclosure with two wheels having locks to prevent free roll. The large LCD screen displays load level, battery level, temperature, voltage and other status of the machine at the touch of the button. It is not only the best choice for generators but also can be used as a UPS for computers and other equipments.



1. Power Switch
2. Power On Indicator
3. Display Select
4. LCD Display
5. Power Inlet
6. AC Input circuit breaker
7. Output Terminal Block
8. Schuko Outlets
- 8a. IEC 320 C13
9. Outlets circuit breaker
10. Battery Inlet
11. Battery circuit breaker
12. Battery Wiring Fault LED
13. Bypass Switch



CPS1000PIE/CPS1500PIE  
CPS3000PIE/CPS5000PIE



CPS3000PIB  
(Battery pack)

#### PRODUCT FEATURES:

- Pure Sine Wave Output
- Multiple Output for Multiple Servers
- Automatic Voltage Regulator (AVR)
- Brownout and Over Voltage Protection
- Microprocessor Based Full Digital Control
- EMI, RFI Noise Suppression
- Protection from lighting induced surges and spikes
- Auto restart/Auto charge
- Battery wiring fault warning indication
- Bypass for charge only mode provided
- Wrong installation protection
- LCD screen displays load level, battery level, temperature, voltage etc.
- Reverse polarity protection
- Battery pack (optional)

#### TECHNICAL SPECIFICATIONS

Model	CPS1000PIE / CPS1500PIE	CPS3000PIE / CPS5000PIE
Capacity ( VA/Watts)	1000VA/1500VA	3000VA/5000VA
Capacity ( VA/Watts)	700W/1000W	2400W/3500W
Operation Technology	AVR ( Double Boost & Single Buck )	AVR ( Boost & Buck )
<b>Input</b>		
Input Voltage Range	140Vac - 300Vac/165Vac - 290Vac	
Input Frequency Range	50/60 Hz +/- 5 Hz (auto sensing)	
DC Input Voltage	24V	24V/48V
<b>AC Output</b>		
Number of Phase	Single Phase	
On Battery Output Voltage	Pure Sine Wave at 220Vac +/- 10%	
On Battery Output Frequency	50/60 Hz +/- 1%	
Overload Protection	On Utility: Circuit Breaker; On Battery: Internal Current Limiting	
Transfer Time ( Typical )	< 10 ms	
Output Receptacles	Schuko * 1 + IEC 320 C13 * 4	Schuko * 2+ Terminal Block
<b>Agency</b>		
Certificated	CE	
<b>Status Indication</b>		
Indicators	Power On, LCD Display	
Audible Alarms	On Battery, Low Battery, Overload	
<b>Environmental</b>		
Operating Temperature	32°F~95°F ( 0°C~35°C )	
Operating Relative Humidity	0 to 95% Non-Condensing	
<b>Physical</b>		
Dimensions (cm)	26.1x20.6x32.5	33.0x26.0x44.0
Weight (Kg)	16.6/18.6	36.0/44.0
Wheels	No	Yes

#All specifications are subject to change without notice. © 2008 Cyber Power Systems. All Trademarks are the property of their owners.





# CyberShield

CyberShield is designed to provide an inexpensive, easy to use and install, local power solution for cable telephony, Wireless Local Loop (WLL), and Fiber To The Home (FTTH) broadband equipment. This unit can notify the service provider of the power supply's status and battery status. CyberShield is the best and convenient battery backup and local power source for broadband and telecom applications in your home and office.



CS24U12V/CS24U12V-12  
CS24C12V2-E/CS24U12V-XL  
CS30U12V-20/CS16U48V-8/CS50U48V

### PRODUCT FEATURES:

- Universal input voltage
- Microprocessor-based intelligent control
- Communication interface
- Optional extendable runtime
- Audible alarm signals utility failure, low battery and replace battery
- Temperature compensated charging
- Cold start capable



### APPLICATIONS:

- FTTx Networks
- Wireless Local Loop Networks
- VoIP and VoDSL
- Cable Telephony
- SOHO Network Communication



## CyberShield Application Chart

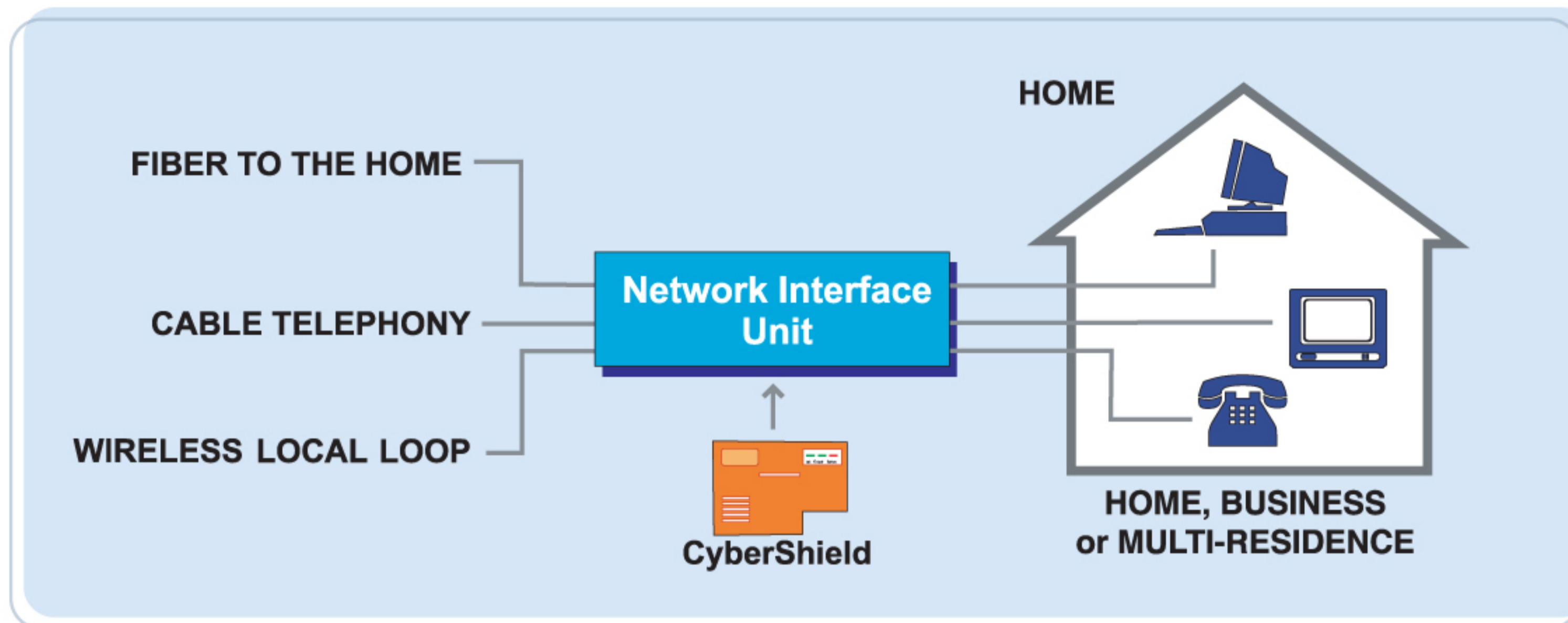

### TECHNICAL SPECIFICATIONS

Model Number	CS24U12V	CS24U12V-12	CS24C12V2-E	CS24U12V-XL	CS30U12V-20	CS16U48V-8	CS50U48V
<b>Operation</b>							
Area of use	Interior	Interior	Exterior	Interior	Interior	Interior	Interior
RoHS Compliant	Yes						
<b>Input</b>							
Voltage Range	85Vac - 264Vac (Universal Input)						
Frequency Range	47 - 70 Hz						
<b>Output</b>							
On Battery Output Voltage	12Vdc			48Vdc			
Continuous Power Capability	24W			30W		16W	50W
Output Power Maximum	24W			30W		16W	50W
<b>Battery</b>							
Sealed, Maintenance Free Lead-Acid Battery	7.2AH/12V	12AH/12V	7.2AH/12V	7.2AH/12V	20AH/12V	8AH/12V	20AH/12V
Intelligent Charging	Unit evaluates battery temperature and adjusts the charging cycle accordingly						
Typical Recharge Time (Hours)	18	24	18	18	42	12	18
User Replaceable	Yes, Hot Swappable						
<b>Warning Diagnostics</b>							
Audible Indicator	Utility Failure, Low Battery						
LED Indicators	AC, Output, Battery						
<b>Management</b>							
Auto-Charge	Yes						
Communication Interface	On Battery, Replace Battery, Battery Missing, Low Battery						
<b>Environment</b>							
Operating Temperature	32°F to 104°F (0°C to 40°C)**						
Operating Humidity	0% - 95% condensing						
Maximum Operating Elevation	10,000ft (3,000m)						
Storage Temperature	5°F to 113°F (-15°C to 45°C)						
Maximum Storage Elevation	50,000ft (15,000m)						
<b>Physical</b>							
Dimensions (cm)	8.9x23.5x15.9	8.9x11.4x15.9	8.9x27.3x20.3	8.9x11.4x15.9	10.2x29.8x27.9	8.9x15.9x11.4	10.2x27.9x29.8
Weight (kg)	3.3	4.9	3.5	3.3	7.7	3.3	7.9

\*\*Exterior unit electronics operating temperature is -40°F to 131°F (-40°C to 46°C) + solar loading. Battery has a trickle charge in lieu of a battery heater.

#All specifications are subject to change without notice. © 2008 Cyber Power Systems, Inc. All Trademarks are the property of their owners.





# CyberSwitch

CyberSwitch is the ultimate power control center with remote switch of individual outlets to manage multiple network devices. This state-of-the-art technology allows network administrators an easy way to control AC power for various connected devices, such as servers, hubs, routers, modems, telephone systems and other equipment.



CSW 8RE

## PRODUCT FEATURES:

- Support TCP/IP, DHCP, SNMP, HTTP
- Local ON/OFF control of each outlet and Remote ON/OFF control devices
- LAN Connectivity
- Used with programmable software for safe-shutdown systems
- User interface with web browser for management
- Daisy Chaining feature to connect with multiple CyberSwitch client units
- EMI/RFI filtering, built-in surge and spike suppression
- LED Indicator

## BENEFITS:

- Control and configure CyberSwitch worldwide through network/internet
- Individual control of each outlets offers a complete and flexible method to operate your equipment
- Built-in Ethernet interface for direct LAN connection
- Easy configuration for initial and system set-up
- Manage and update device status anywhere anytime
- Simple set-up to save your time, money and resource by using only one IP address to manage multiple devices
- To remove possible noise, surge, and spike interference for better protection of your devices
- Front panel LEDs indicate the status of connected loads



## Sample Network Configuration of CyberSwitch

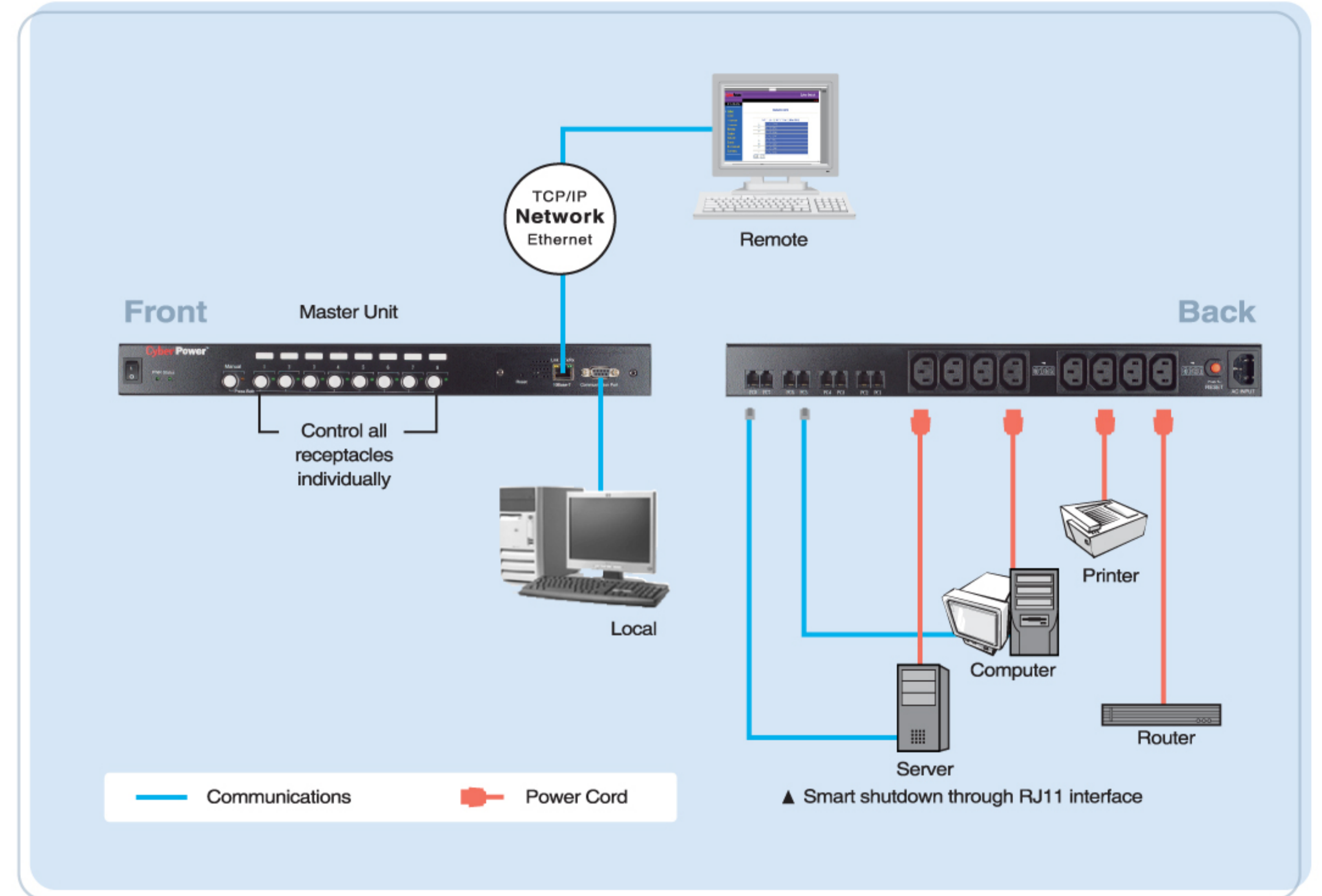

## TECHNICAL SPECIFICATIONS

Model	CSW 8RE
<b>Input</b>	
Normal Input Voltage	220 - 240Vac
Acceptable Input Voltage	90 - 270Vac
Normal Input Frequency	47 - 63Hz
Over-current Protection	10-A Circuit Breaker
Input Connector	3.33m attached IEC 320
<b>Output</b>	
Output Socket	8 IEC 320 Outlets
<b>Environmental</b>	
Operating Temperature	32 to 113 °F (0 to 45 °C)
Storage Temperature	5 to 158 °F (-15 to 65 °C)
Relative Humidity	0-95%, Non-Condensing
<b>Physical</b>	
Dimensions (cm)	4.5x43.9x12.0
Weight (kg)	2.12

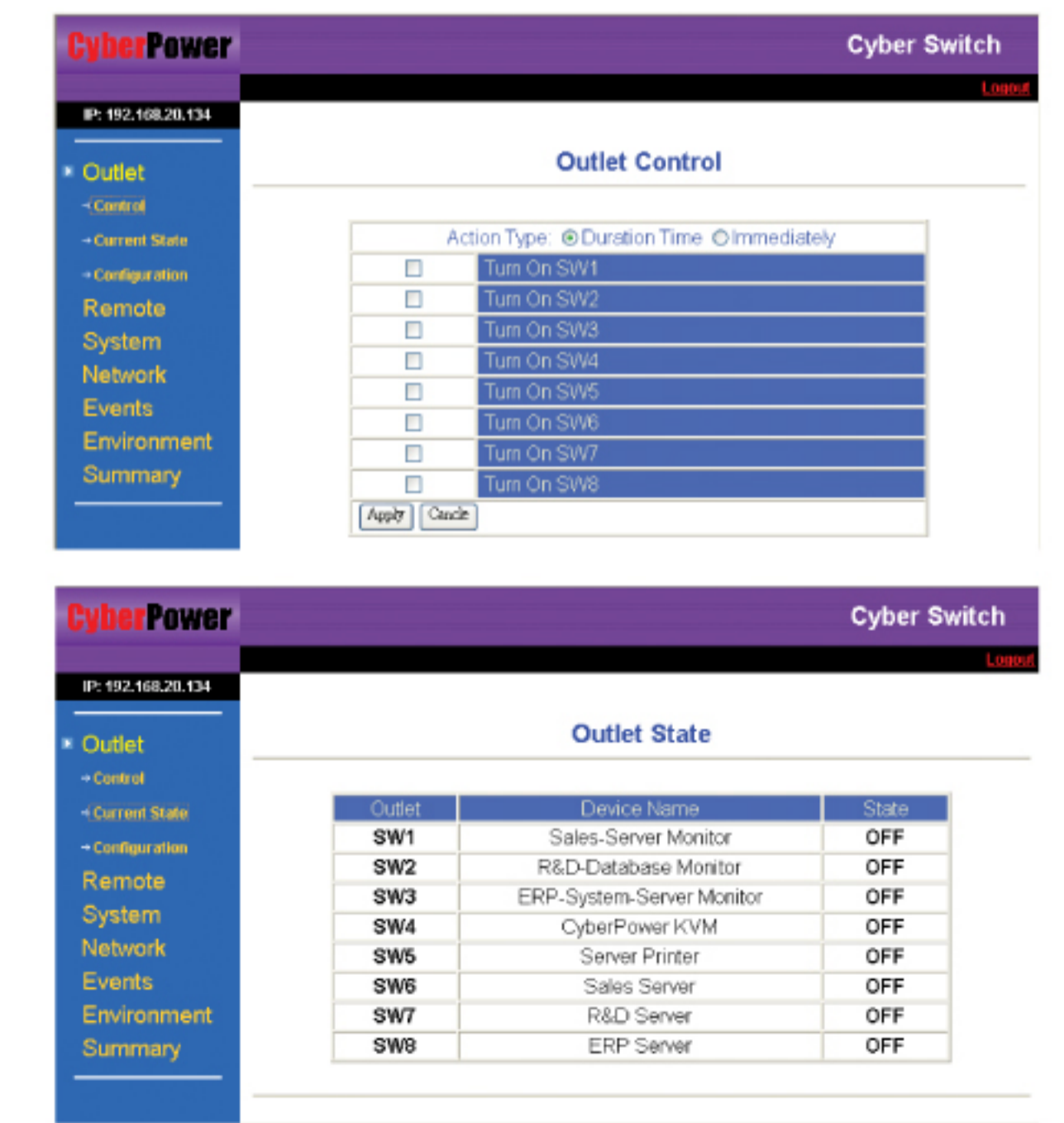

#All specifications are subject to change without notice. © 2008 Cyber Power Systems. All Trademarks are the property of their owners.



# Surge Protector

Can you tolerate lightning and other power disturbances suddenly destroy your valuable computer, equipment, and data in an instant? We truly believe the answer is NO. CyberPower Surge Protector offers world-class protection from harmful and power events for your power tools, work lights and sensitive equipment all over the world. Two and three prong AC adapters are included in CPS 500NBP to fit all notebook computers.



## CPS 500NBP

The Notebook Surge Protector protects your notebook computer and its phone/fax/network from damage of surges, spikes, and lightning anywhere throughout the world. Besides, it provides Net connection(RJ45) and EMI/RFI noise filter protection functions.



Two and three prong AC adapters are included



### TECHNICAL SPECIFICATIONS:

Model	CPS 500NBP
<b>Input</b>	
Voltage Range	100Vac - 240Vac
Frequency Range	50/60Hz
<b>Surge Protection and Filtering</b>	
Surge Protection	500 Joules
EMI/RFI Noise Filter	Yes
Phone/Fax/Network Protection	RJ11/RJ45 ( One In/One Out )
<b>LED Indicator Lights</b>	
Surge	Yes
Power	Yes
<b>Physical</b>	
Dimensions (cm)	13.5x4.5x3.6
Weight (kg)	0.44

## CPS VG5

The CPS-VG5 surge protector is a perfect All-Purpose Electronic Surge Protector. It provides protection from lightning induced surges and spikes, safe-guarding your connected equipment from the dangers of these power anomalies, The CPS-VG5 is ideal for your Personal Computer, TVs, Stereos, CD Players, and DVDs.



Model	CPS VG5
<b>Product Overview</b>	5 outlet power strip
Voltage Compatibility	250Vac
Frequency Compatibility	50/60Hz
<b>Output</b>	
Output Volt Amp Capacity (amps)	10A/15A
Outlet Orientation	Single row of 5
<b>Input</b>	
Input Cord Length (ft.)	6/7/8
Recommended Electrical Service	10A/15A, 250V
<b>Surge Protection and Filtering</b>	
Surge Protection	300 Joules
EMI/RFI Noise Filter	Yes
Phone/Fax/Network Protection	Option
<b>LEDs alarms, switches &amp; protection</b>	
Protection	Circuit Breaker
Switches	On/Off
<b>Physical</b>	
Dimensions (cm)	35.7x5.2x4.05

# SNMP / HTTP Network Solution

SNMP/HTTP Network solution is the most easy-to-use and convenient solution for you to remotely manage, monitor, and control your UPS via internet browser at any time.

### PRODUCT FEATURES:

- Real-time UPS monitoring
- Remote management and configuration of UPS via Web Browser or NMS
- Support TCP/IP, UDP, SNMP/HTTP protocol
- Auto-shutdown to protect servers/workstations from data loss due to power failure
- Schedule shutdown/start-up/reboot of UPS via remote control
- Event logging to trace UPS operation history
- SNMP MIB provided
- 10Mbps fast Ethernet compatible
- Quick installation and user friendly interface
- Security management provided

### SNMP/HTTP Card



### CyberPower Viewer

(Monitor, Manage, and Configure UPS)

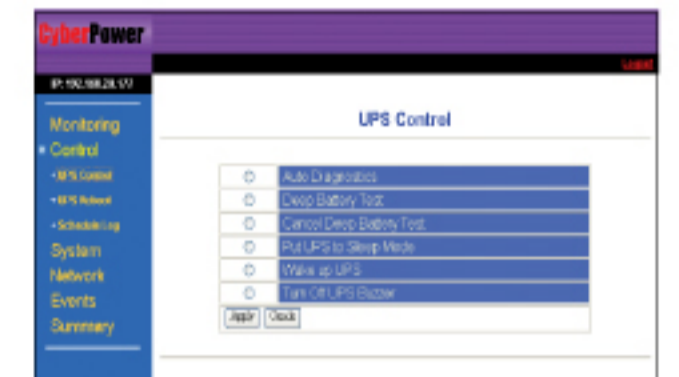

### ■ CyberPower Viewer:

Via a web browser you can access the UPS and have real-time monitoring and control. An easy-to-use interface will guide you through main operations as follows:

- **Monitoring**  
A summary table to show product info. And current status of your UPS including voltage/frequency, Load, battery capacity, temperature and etc.
- **Control**  
To execute basic operation of your UPS, you may use remote control here. With one click, you can command UPS to do self diagnostics, to test battery, to go to sleep mode, to silence buzzer, to reboot and to schedule power on/off daily, weekly or specially.
- **Network**  
Defining NMS to access SNMP or receive traps.
- **Event**  
Listing power events and description of actions taken.

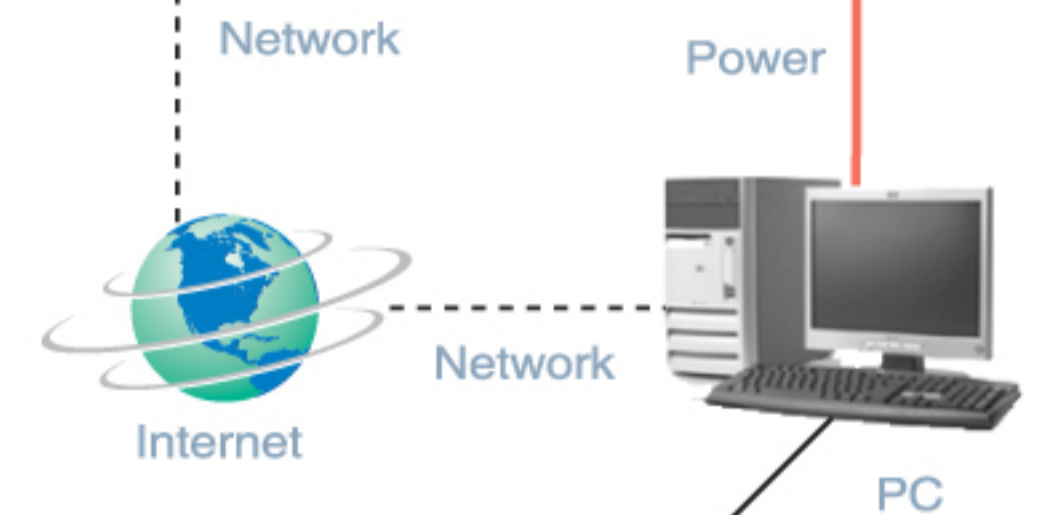

### PowerPanel® Shutdown Service

(Protect your PC/Servers/Workstations)

### ■ PowerPanel® Shutdown Service:

Servers / workstations protected by UPS must be installed with PowerPanel® Shutdown Service to enjoy extra value-packaged features below.

- **UPS status notification**  
Define recipients of event notification who are under the same domain name with that of the protected servers/workstations.
- **Safe shutdown operation**  
Configure graceful shutdown of the protected servers/workstations.
- **User Programmable Command File**  
In the event action section, we provide flexibility for addition of your own command file to perform a specific action.



# Power Inverters

Compact DC-to-AC inverter, provides safe, economical and convenient mobile power source, transferring your vehicles 12V power to your laptop and accessories. This is an outstanding power solution designed to fit all standard cupholder. On-the-road AC Power to go.



### APPLICATIONS:

- Mobile Power for Notebooks
- Portable DVD Players
- Mobile Phones
- Gaming Consoles
- PDA

### PRODUCT FEATURES:

- Compact and lightweight design
- Power-on LED indicator
- Tangle-free 36 inch cord
- 12V DC cigarette lighter plug with built-in airplane adapter plug
- Fit all standard vehicle lighter sockets
- Built-in surge protection allows for safe car start-up and shutdown
- Low battery shutdown when DC voltage falls to 10.5V or less
- Build-in splitter runs AC and DC simultaneously
- Use one AC device and power/recharge your cell phone at the same time
- Auto-shutdown feature protects your car's battery from draining



e4  
020798

### TECHNICAL SPECIFICATIONS:

Model	CPS 140UPE
Capacity (Watts)	140W
<b>Input</b>	
Voltage (Nominal)	12Vdc
DC Input Voltage Range	10.5 - 15.8Vdc
<b>Output</b>	
Voltage (Nominal)	230Vac +/- 5%
DC Voltage	12Vdc (Cigarette Jack)
Frequency	50Hz +/- 3%
Continuous Output Power	140W
Peak Output Power	270W
<b>Protection</b>	
Overload Protection	Yes
Overheat Protection	Automatic overheat shut-off at 150 °F (65.5 °C)
Low Battery Voltage Alarm	Notifies user when DC voltage falls to 11.5V or less
Audible Alarm	Overheat, Overload: Long Beep
Cooling Method	Heat emitting from the housing surface/cooling fan
<b>Physical</b>	
Dimensions (cm)	15.0x5.7x7.0
Weight (kg)	1.95

#All specifications are subject to change without notice.  
© 2008 Cyber Power Systems. All Trademarks are the property of their owners.

Also lays flat for dashboard mounting



# Cables

CyberPower provides cables to support existing and emerging technologies.

### TECHNICAL SPECIFICATIONS

Category	Model	Length	Connector	
USB Cable	USB-1.8AB 2.0GG	6'	A/M to B/M Nickel Plated	
	USB-3AB 2.0SBG	10'	A/M to B/M Nickel Plated	
	USB-2XAA 2.0 SS	6'5"	A/M to A/F Nickel Plated	
	USB-5AB 2.0 SS	16'4"	A/M to B/M Nickel Plated	
	USB-2AB 2.0 PG	6'5"	A/M - B/M 24K Gold Plated	
	USB-5AB 2.0 PG	16'4"	A/M - B/M 24K Gold Plated	
Network Cable	Cat5e	350-07-SSL	7'	RJ45-RJ45, Gold Plated
		350-14-SSL	14'	RJ45-RJ45, Gold Plated
		350-25-SSL	25'	RJ45-RJ45, Gold Plated
		350-50-SSL	50'	RJ45-RJ45, Gold Plated
	Cat6	500-07-SPU	7'	RJ45-RJ45, Gold Plated
		500-14-SPU	14'	RJ45-RJ45, Gold Plated
		500-25-SPU	25'	RJ45-RJ45, Gold Plated
		500-50-SPU	50'	RJ45-RJ45, Gold Plated
FireWire Cable	FW1394 4-4	6'	4 Pin -4 Pin	
	FW1394 6-4	6'	6 Pin -4 Pin	
	FW1394 6-6	6'	6 Pin -6 Pin	
Printer Cable	EPP 103/10	10'	DB25 to Centronics	
HDMI Cable	HDMI-719	7'	19 Pin -19 Pin	
RCA Cable	RCA6FT	6'	3 RCA Plug-RCA Plug	

#All specifications are subject to change without notice.  
© 2008 Cyber Power Systems. All Trademarks are the property of their owners.



# USB HUB

The Only USB Hub with battery powered on the market is designed by CyberPower, and it can easily connect 4 port USB devices at home or on the road. You can utilize battery power to provide sufficient power to your USB hub and no longer need to carry the cumbersome AC Power Adapter.



## CPH420MP 4 Port USB 2.0 HUB Mobile USB HUB with Battery Powered

### PRODUCT FEATURES:

- Fully compatible with all USB 2.0/1.1 devices
- On-the-road SELF power
- Power and battery discharge indicator lights
- Batteries automatically recharge when plugged into PC
- Battery discharge on/off switch
- Rechargeable Ni-MH Batteries included
- No AC Power Adapter Required

## CPH411/CPH420P CPH720P/CPH743P

### PRODUCT FEATURES:

- USB 1.1 (CP H411)/2.0 compliant
- Support 480/12/1.5 Mbps data transfer rate
- Support up to 127 Hi-speed devices
- Support multiple USB 2.0 and USB 1.1 devices simultaneously
- LEDs indicate power and active port status
- Direct plug and play connectively
- Over-current detection and protection
- CE/USB 2.0-IF

### TECHNICAL SPECIFICATIONS:

Model No.	CPH411	CPH420P	CPH420MP	CPH720P	CPH743P
Model Name	USB 4 Port Hub	USB 2.0 4 Port Hub	Mobile USB 2.0 Battery Powered Hub	USB 2.0 7 Port Hub	USB 2.0/FireWire 7 Port Combo Hub
LEDs	Power	1	1(USB Power Indicator ) 1(Battery discharge Indicator)	1	1(USB Power Indicator ) 1(Firewire Power Indicator )
	Port	0	4	0	7
Power Mode	Bus-Power		Self-Power		
Housing			Plastic		
System Compliant	Windows 98/98SE/2000/ME/XP, Mac OS 8.6/9.X/10.1 or above				
Dimension (cm)	5.8x5.5x1.8	6.7x6.4x2.0	6.5x9.9x1.8	5.8x10.2x2.1	5.8x10.2x2.1
Power Adapter	N/A	5V 2.6Amp	N/A	5V 3.6Amp	5V 2.6Amp

#All specifications are subject to change without notice. © 2008 Cyber Power Systems. All Trademarks are the property of their owners.



# Power Management Applications

## PowerPanel® UPS Management



### FEATURES & BENEFITS:

- Easy installation
- Allow for scheduled shutdown of your computer system
- Save open files, closes applications and shut down your computer in an orderly manner when a power outage occurs



## PowerPanel® Personal Edition

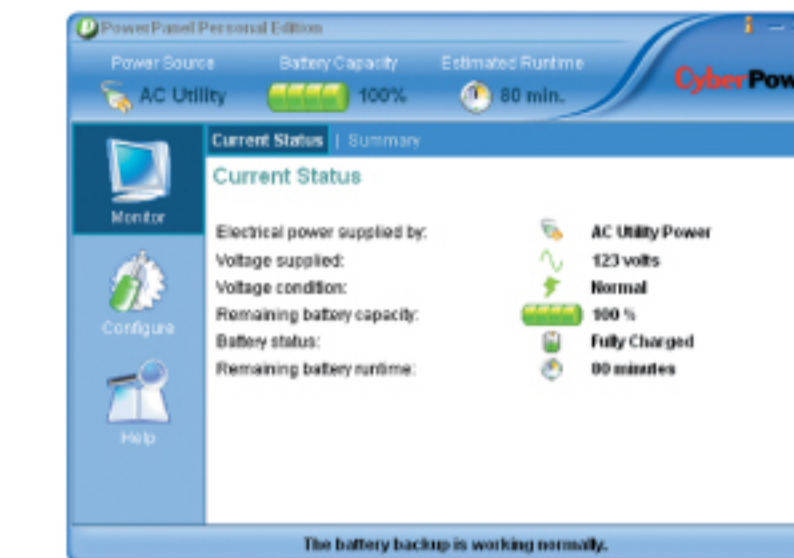

### FEATURES & BENEFITS:

- Easy Installation
- Programmable voltage regulation
- Display output voltage, approximate backup time, load watt, battery capacity
- Hibernate or save files and shut down your computer in an orderly manner when a power outage occurs
- Summary of voltage condition



## PowerPanel Plus® UPS Management



### FEATURES & BENEFITS:

- Plug and Play
- Programmable voltage regulation
- Allow for scheduled shutdown and restart of your computer system
- Display input-output voltage, approximate backup time, frequency and unit temperature
- Save open files, closes applications and shut down your computer in an orderly manner when a power outage occurs



## PowerPanel® Business Edition

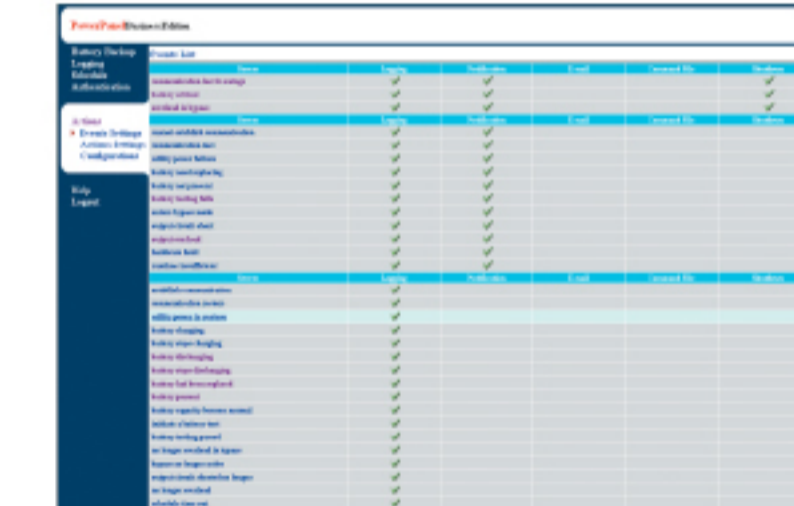

### FEATURES & BENEFITS:

- Monitor voltage, frequency, cabinet temperature, and approximate uptime of battery backup.
- Allows scheduled shutdown and restart of your computer system, and performs diagnostics for battery test or runtime calibration.
- Logs status and events to trace the operation history. Log options are provided.
- Supports user-defined settings for each model of battery backup.
- Supports flexible definitions for event notifications, a shutdown sequence and a user-defined command file in response to each event.



# Serial to USB Adapter

• Optional Serial-to-USB conversion cable allows flexibility in deploying UPS units

• Allow the same units to be deployed across all operating systems

• Provide ability to standardize UPS systems



