



Chazelles
— CHEMINÉES • INSERTS • POÊLES —





Passez en mode bien-être,

et faites le choix du confort et de la sécurité d'une grande marque française. Depuis plus de trente ans, Chazelles investit sur une politique «haute performance». Nous accordons un grand soin à la qualité des matériaux sélectionnés dans la fabrication de nos produits afin de garantir les meilleurs rendements énergétiques.

EMBRACE THE 'WELLNESS' LIFESTYLE,

and choose the security and the reliability of a well known French brand. For over 30 years, Chazelles constantly follows a "high performance" policy. We take the greatest care of the quality of the materials selected for the manufacturing of our products, to ensure the best energy efficiencies.

Chazelles
— CHEMINÉES - INSERTS - POÊLES —

www.chazelles.com



Sommaire

Content

CHAZELLES

- 4** Fabricant français
French manufacturer
- 5** Le chauffage Haute Performance
High Performance heating
- 6** La garantie Bien-être 10 ans
10 years wellness warranty
- 8** La qualité
Quality
- 10** Réseau de distribution
Dealer's network
- 12** Repères & labels
reference & certification
- 14** Les avantages financiers
Financial advantages
- 15** Les avantages granulés
Pellets advantages

flashcode



web



Ce catalogue a été imprimé en France sur du papier blanchi sans chlore, issu de forêts gérées durablement, dont les arbres sont plantés spécialement pour la fabrication de la pâte à papier.

This catalog was printed in France on a bleached paper without chlorine from sustainably managed forests, whose trees are planted specifically for the manufacture of paper pulp.

La liste des produits ou références, les textes, côtes, images et illustrations, la composition et la couleur des produits, les informations techniques figurant dans ce catalogue n'ont aucune valeur contractuelle. Sous réserve d'erreur d'impression. Pour plus d'information, contactez votre concessionnaire ou l'usine. Pour améliorer la qualité de ses produits ou pour des raisons techniques, le fabricant peut à tout moment modifier les informations contenues dans ce catalogue. Les photos présentées dans ce catalogue n'ont aucune valeur contractuelle, dans la mesure où l'impression, la qualité du papier, les éclairages de prises de vues peuvent faire varier les couleurs et textures des différents matériaux de nos produits. Edition juin 2014. Création : TOSCARA. Photos : Le Studio Photographique / Studio Langereau / Communication 22 / Getty Images / Fotolia. Remerciement : Logis de Puygaty.

The list of products or references, texts, ratings, images and illustrations, the composition and colour of products, and the technical information appearing in this catalogue have no contractual value, no liability for printing errors. For more information contact your stockist or the plant. To improve the quality of his products or for technical reasons, the manufacturer may amend the information in this catalogue at any time, published June 2014. Creation: TOSCARA. Photos: Le Studio photographique / Studio Langereau / Communication22/Corbis / Getty Images / Fotolia. Thanks to: Logis de Puygaty

LES POÊLES

STOVES

- 16** Les poêles à granulés *Pellet stoves*
- 34** Les poêles à bois *Wood stoves*
- 48** Les poêles en pierre ollaire *Soapstones stoves*
- 50** Les cheminées métal *Metallic fireplaces*

LES INSERTS

INSERTS

- 60** Les inserts à granulés *Pellet inserts*
- 68** Les inserts à bois en fonte *Cast-iron wood inserts*
- 80** Les inserts à bois en acier *Steel wood inserts*
- 92** Les inserts hydro *Hydro inserts*

94 Collection Habillage *Fireplaces Lines*

96 Côté jardin *Garden living*

98 Index *Index*

99 Symboles *Symbols*

Chazelles

FABRICANT FRANÇAIS
FRENCH MANUFACTURER



La tradition, le savoir-faire et l'innovation technologique au service d'une très haute maîtrise du feu. Depuis plus de trente ans, Chazelles conçoit, développe dans son usine les cheminées, poêles et inserts de votre habitat. Le choix d'une fabrication française pour une garantie optimale.

Tradition, know-how and technological innovation to ensure the highest level of fire control. For over thirty years, in its factory Chazelles designs, develops fireplaces, stoves and inserts for your home. Make the choice of a French manufacturer for an optimal satisfaction.

LE CHAUFFAGE HAUTE PERFORMANCE *HIGH PERFORMANCE HEATING*



LA MAÎTRISE TECHNOLOGIQUE DU FEU *TECHNOLOGICAL MASTERY OF FIRE*

La sérénité Chazelles, c'est l'assurance d'un matériel haute performance, vous offrant les meilleures garanties de chauffage et de fiabilité dans le temps.

Nous maîtrisons l'ensemble de la chaîne : de la conception à la fabrication.

Chazelles relies on its high-performance appliances, giving you the best guarantees heating and reliability over time.

We control the entire line : from design to manufacturing.

*Renseignez-vous auprès de votre revendeur Chazelles.
Information from your dealer.



VOTRE MEILLEURE
GARANTIE
BIEN-ÊTRE

THE BEST WARRANTY OF WELLNESS

Parce que la sérénité Chazelles, c'est aussi la fiabilité maximale d'un matériel Haute Performance. Chazelles est la Première marque française à proposer à ses clients la GARANTIE BIEN-ETRE 10 ANS*.

Chazelles serenity, it is also the maximum reliability of equipment High Performance. Chazelles is the first French brand to offer its customers 10 YEARS WELLNESS WARRANTY.*

*Renseignez-vous auprès de votre revendeur Chazelles.
Information from your dealer.





La qualité
d'un service personnalisé.

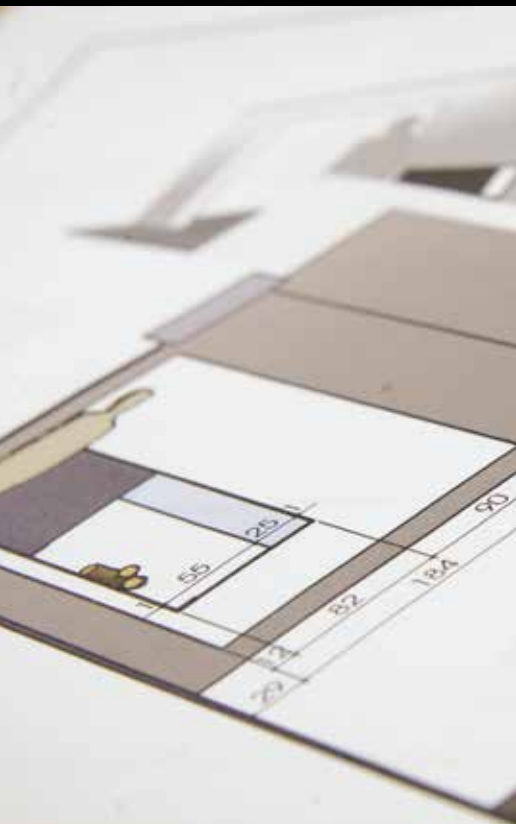

Le savoir-faire et la maîtrise
de la pose garantis par notre réseau
d'experts certifiés

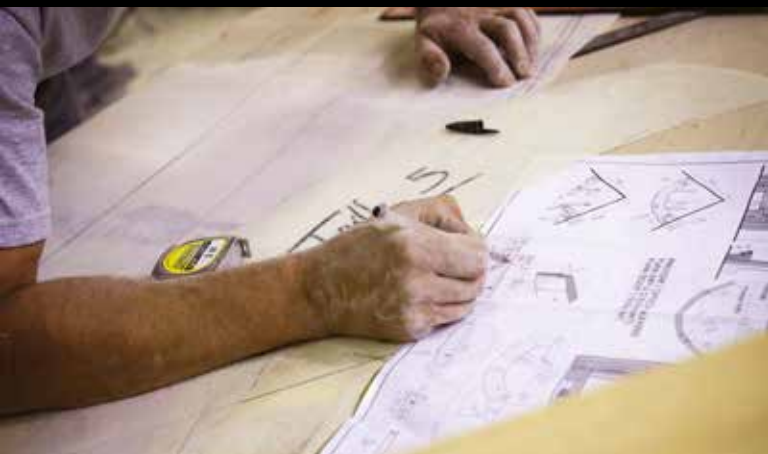

*The quality of personalized service. Know-how and
expertise of installation are guaranteed by our network
of certified experts*



EN FRANCE...

Le réseau de Chazelles compte plus de 110 professionnels répartis sur tout le territoire national.

Votre concessionnaire Chazelles n'est pas qu'un simple vendeur ; professionnel aguerri il saura vous faire profiter de son expertise, et vous faire bénéficier du service Chazelles :

- Pour vous guider dans le choix de votre cheminée ou de votre appareil de chauffage, en fonction de vos attentes en matière : de décoration, de performance de chauffage, de vos contraintes d'implantation, de vos contraintes budgétaires...
- Pour vous accompagner à toutes les étapes de votre projet car il bénéficie de l'appui permanent des équipes du bureau d'étude et de l'usine de fabrication de Chazelles,
- Pour vous informer sur les normes de sécurité, les avantages fiscaux, et vous proposer des solutions de financement,
- Pour répondre à vos interrogations même après l'installation de votre projet.

ET DANS LE MONDE

Chazelles connaît un très fort développement à l'international. Notre marque est présente dans une trentaine de pays, en Europe, Pays de l'Est, Moyen Orient et Australie. Des gammes spécifiques de produits y sont exportées, avec un succès croissant, tant pour les cheminées que pour les appareils de chauffage. Cette distribution internationale contribue fortement au rayonnement de Chazelles.

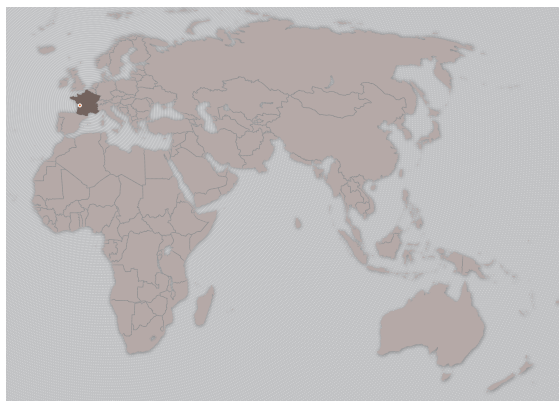

IN FRANCE...

Chazelles network represents over 110 professionals throughout the national territory.

Your Chazelles dealer is not just a reseller but a qualified professional who will help you to take advantage of its expertise to offer you all Chazelles services:

- To give you the best advice for choosing your fireplace or your insert, depending on your expectations: design, heating performance, location constraints, budget ...
- To help you at every stage of your project he benefits from the support teams of the Chazelles office and factory team.
- To inform you about safety standards and offer you financing solutions.
- To answer to your questions even after the installation of your project.

... AND WORLDWIDE

Chazelles is currently undergoing a very strong international development. Our brand is present in thirty countries in Europe, Eastern Europe, Middle East and Australia. Specific ranges of products are exported, with a growing success for fireplaces as well as heating appliances. This international network contributes significantly to the reputation of Chazelles.

Pour connaître le concessionnaire Chazelles le plus proche de chez vous, consultez notre site internet :

To locate the nearest dealer, visit our website :

www.chazelles.com

Chazelles

EN FRANCE, ET DANS LE MONDE

IN FRANCE AND WORLDWIDE



DES GESTES SIMPLES POUR PRÉSERVER L'ENVIRONNEMENT

A FEW SIMPLE ACTIONS TO PRESERVE THE ENVIRONMENT

UTILISER LE BON BOIS

Bois bien sec (moins de 20% d'humidité), stocké dans un endroit sec et bien aéré. Le temps de séchage optimal pour un bois sec :

- sous abri : quartiers ou rondins de 33 cm : de 15 à 17 mois
- à l'air libre : stère en quartiers ou rondins de 1 m : de 18 à + de 24 mois

Deux grandes familles d'essence de bois :

- Feuillus durs : chêne, hêtre, frêne, charme, noyer, fruitiers... ; très appréciés pour le chauffage domestique, sauf le châtaignier qui éclate en brûlant.
- Feuillus tendres et résineux : épicéa, sapin, pin, mélèze, peuplier, saule, sont appréciés pour leur montée rapide en température, mais brûlent aussi plus rapidement.

Exclure l'utilisation de :

- Bois souillé (issu de récupération – vieux meubles, chantier de démolition...), car il contient des substances toxiques qui se retrouvent dans les fumées (vernis, peinture, produits de traitement...).
- Bois humide : sa combustion libère davantage de substances polluantes, fournissant 2 fois moins d'énergie qu'un bois sec. Il dégrade prématurément votre appareil (encrassement, corrosion) et l'empêche de fonctionner dans les meilleures conditions.



CHOOSE A GOOD WOOD

Dry wood (less than 20% moisture content), stored in a dry, well aerated place. Optimal drying time for dry wood:

- under cover: 33 cm logs or pieces: from 15 to 17 months
- in the open air: stee of 1 metre logs or pieces: from 18 to 24+ months

Two families of tree species:

- Hardwoods: oak, beech, ash, hornbeam, walnut, fruit trees, etc. – much better for household heating, with the exception of chestnut, which sends up sparks when burned.
- Softwoods: spruce, fir, pine, larch, poplar and willow are all to be appreciated for the quick heat they provide, but they also burn more quickly.

Avoid using:

- Soiled wood (recovered from old furniture, demolition sites, etc.), as it contains toxic matter that is released in the smoke it gives off (varnish, paint, processing products, etc.).
- Damp wood: burning it releases more pollutants and gives off half the energy of dry wood. It also leads to premature degradation of your appliance (sooting up and corrosion) and prevents it from operating under the best conditions.

LABELS CERTIFICATION

BOIS



Le label NF Bois de chauffage a été créé sous l'impulsion de l'ADEME afin d'inciter les utilisateurs de bois à utiliser un combustible certifié, dont les propriétés clairement définies sont respectées par le fabricant et vérifiées par un organisme indépendant. Les entreprises certifiées garantissent le groupe d'essences, la longueur, le niveau d'humidité et la quantité livrée en stères. (Plus d'infos : www.nfboisdechauffage.org)

Consommation : la consommation moyenne de bois est de 8 stères/an en énergie principale, et de seulement 4 stères en usage d'appoint. (Source SER)

Le bois est actuellement le combustible le moins cher du marché.

WOOD

The NF 'Bois de chauffage' label was created by the ADEME organism with the aim of encouraging wood users to use a certified fuel which properties are respected by the manufacturer and checked by an independent body. Certified companies guarantee group of species, length, moisture content level and quantity delivered in steers. (For more information: www.nfboisdechauffage.org)

Consumption: average wood consumption is 8 steers/year in main heating, and only 4 steers in back-up use. (Source: SER)

Wood is currently the cheapest fuel on the market.

GRANULÉS

Les granulés certifiés DIN+, EN+ et NF Biocombustibles solides granulés (bois qualité Haute Performance) assurent une combustion optimale. La certification assure que les produits répondent bien aux normes.

Seuls les granulés labellisés comme ci-dessous sont autorisés comme combustible.

Nouveau label - Fortement recommandé

Les granulés de bois sont des cylindres de sciures compressés, entièrement naturels (sans ajout de liant chimique). Les granulés peuvent être fabriqués à partir de sciure de résineux ou de feuillus d'un diamètre moyen de 6 mm et d'une longueur comprise entre 20 et 30 mm. Les granulés bois doivent être utilisés exclusivement dans des poêles ou inserts à granulés.



PELLETS

Pellets certified DIN+, EN+ and NF Solid biofuel pellets (quality wood high performance), ensure an optimal combustion. Only the certified pellets (please refer to the logo below) are allowed to be used as fuel.

New label – Highly recommended

Wood pellet are cylindrical compressed sawdust, entirely natural (without any chemicals), ensure an optimal combustion. Only the certified pellets (please refer to the logo below) are allowed to be used as fuel. Wood pellet must be used exclusively in pellet stoves or inserts.



ET OPTIMISER VOTRE CHAUFFAGE

AND OPTIMIZE YOUR HEATING SYSTEM



UTILISER UN APPAREIL CHAZELLES LABELLISÉ FLAMME VERTE

- Grâce au label Flamme Verte, les Cheminées de Chazelles garantissent leurs appareils conformes aux normes en vigueur, respectant le seuil minimum de rendement et le taux maximum de polluants, c'est à dire moins consommateurs de bois et peu polluants.
- Le rendement correspond à la quantité de chaleur restituée par le combustible lorsqu'il brûle dans un insert ; le reste part en fumée. Le rendement d'un appareil de chauffage dépend aussi beaucoup des caractéristiques du combustible.
- Bon à savoir : Le passage d'un rendement de 50 à 70% permet d'économiser près de 30% de bois.

Use a Chazelles appliance with the 'Flamme Verte' label

- *With the 'Flamme Verte' label, Cheminées de Chazelles attests that its appliances are conform to the standards currently in force, in compliance with the minimum output threshold and the maximum pollution rate – which means that the appliances consume less wood and cause little pollution.*
- *Output corresponds to the amount of heat given off by the fuel when it is burning in an insert; the rest goes up as smoke. A heating appliance's output depends also very much on the characteristics of the fuel used.*
- *Useful to know: Going from 50 to 70% output economises almost 30% in terms of wood consumption.*



Le label QualiBois, une garantie pour l'installation

QualiBois est un label désignant un équipement de qualité pour les chauffages alimentés par des biocombustibles tels que les bûches et les granulés.

QualiBois est un gage de sérieux et de qualité pour les entreprises qualifiées installant des inserts et poêles, pour la production de chauffage et d'eau chaude sanitaire.

Reconnu « Grenelle Environnement », le label QualiBois est une appellation de confiance recommandée par l'ADEME et les collectivités territoriales.

QUALIBOIS. warranty for a good installation

QualiBois label certifies the quality of heating appliances installation.

QualiBois is a warranty of reliability and quality for qualified companies installing inserts and stoves (wood and pellets), for heating and producing hot water.

QualiBois is a reliable label recommended by ADEME and local authorities (France).



AVANTAGES FINANCIERS

FINANCIAL ADVANTAGES

(Selon les dispositions gouvernementales en vigueur à la date d'impression de ce catalogue).

• Crédit d'impôt

L'installation d'une cheminée avec insert ou d'un poêle labellisé Flamme Verte ouvre droit à un crédit d'impôt pour un renouvellement ou pour une primo acquisition. Conformément à l'article 200 quater du code général des impôts. Arrêté du 13 novembre 2007 en vigueur concernant les critères d'éligibilité.

Les conditions pour en bénéficier : pour une habitation principale, l'appareil doit être facturé et installé par la même entreprise. Pour connaître le plafond des dépenses et les démarches à effectuer ; renseignez-vous sur www.ademe.fr

• Taux de TVA

Le taux de TVA de 10% est applicable pour toutes les personnes (propriétaire occupant, propriétaire bailleur, locataire, occupant à titre gratuit) faisant installer un équipement de chauffage au bois. Le taux est de 5,5% si l'appareil bénéficie du crédit d'impôt (fourniture et pose) dans un logement achevé depuis plus de 2 ans.

• Aide de l'ANAH (www.anah.fr)

L'Agence Nationale pour l'Amélioration de l'Habitat octroie une aide financière aux propriétaires occupants faisant l'acquisition d'un appareil labellisé Flamme Verte.

• Eco-prêts

Que ce soit pour une construction ou une rénovation, vous pouvez bénéficier d'éco-prêts dédiés aux économies d'énergies.

Info : www.ademe.fr

(According to governmental provisions in force at the time this catalogue was printed). **Valid for French tax residents only.**

• Tax Credit

The installation of a fireplace with insert or stove Flamme Verte label entitles you to a tax credit for a renewal or a primary acquisition. Accordance with Article 200 quater of the General Tax Code. Order of 13 November 2007 in force on the eligibility criteria. The eligibility conditions: for a main house, the unit must be charged and installed by the same company. For information on the expenditure ceiling and necessary procedures, visit www.ademe.fr

• VAT rate

The VAT rate to 10%, for anybody (owner-occupier, owner-lessee, tenant, or non-paying occupant) installing a wood-fuelled heating appliance (installation and materials included) in housing completed over two years ago. The VAT rate is 5.5% if the appliance is tax credit.

• Assistance from the ANAH (www.anah.fr)

The Agence Nationale pour l'Amélioration de l'Habitat (ANAH – French housing improvement agency) grants financial aid to owner-occupiers acquiring appliances bearing the 'Flamme Verte' label.

• Eco-Loan

For construction or renovate you can benefit from eco-loan to saving energy.

Info : www.ademe.fr



AVANTAGES GRANULÉS PELLETS ADVANTAGES

10 bonnes raisons de choisir un appareil Chazelles 10 good reasons to choose a Chazelles appliance

1. Performances et qualités certifiées (label 5* Flamme Verte, EN 14785, BImSchV, 15a B-VG).

Certified performances and qualities (5 Flamme Verte label, EN 14785, BImSchV, 15a B-VG).*

2. Compatibles aux exigences BBC.

Compatible with the LEB (Low Energy Buildings).

3. Fonction GSM qui permet de commander le poêle à distance (allumage et arrêt, réglage de la température ambiante souhaitée, puissance de fonctionnement) grâce à l'envoi de SMS (possibilité de configurer 3 numéros différents)*.

GSM function which can control the stove away (start and stop, setting the desired room temperature, operating power) by sending SMS (can set three different numbers).*

4. Entretien facile : chambre de combustion et tiroir cendrier très accessibles.

Easy maintenance: combustion chamber and ash drawer easily accessible.

5. Télécommande radio ou infrarouge (horloge, sonde de température intégrée*, réglage de la température, etc.).

Radio or infrared remote control (clock, embedded temperature probe, temperature setting, etc.).*

6. Programmation sur 4 plages horaires possibles par jour.

Programming of the temperature with 4 time slots per day.

7. Puissance réglée : fonction Stop & Go ou ralenti (à choisir en fonction de vos besoins et de la maison).

Regulated power: Stop & Go or Slow function (according to your needs and the characteristics of your house).

8. Allumage rapide avec faible consommation électrique.

Quick lighting up with low electricity consumption

9. Fonction "Silence +" pour plus de confort (arrêt des ventilateurs de convection)*.

"Silence +" function for more confort (convection fans stopped).*

10. Poignée sécurité enfant, aimantée et amovible.

Magnetic, removable, child safety handle.

* selon modèles

* on some models

Les poêles à granulés

PELLET STOVES





NEW

OLZONE

POËLE ÉTANCHE EN ACIER
 AIRTIGHT STEEL STOVE
 6,5 kW OU 9 kW

Dim. : 570 (L) x 510 (P) x 1200 (H) mm
 Dim.: 570 (W) x 510 (D) x 1200 (H) mm

6	kw	2,24-6,24	9	kw	2,24-9,02
kg	120	mm	80		
			0		
€		*****	G=	2	





NEW

GT

POÊLE EN ACIER
STEEL STOVE

Dim. : 534 (L) x 495 (P) x 1045 (H) mm
Dim.: 534 (W) x 495 (D) x 1045 (H) mm

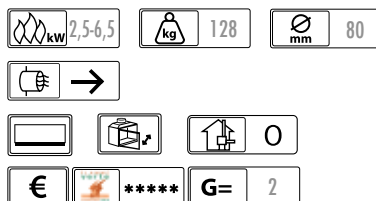







NEW

COMPACT

POËLE EN ACIER
STEEL STOVE



Dim. : 1001 (L) x 250 (P) x 1008 (H) mm
Dim.: 1001 (W) x 250 (D) x 1008 (H) mm

 kW 3-13
  100
  80

 →



 0

 *****
  = 2





NEW

ELANCE
 POÊLE EN ACIER
 STEEL STOVE

Dim. : 570 (L) x 543 (P) x 1200 (H) mm
 Dim.: 570 (W) x 543 (D) x 1200 (H) mm

kW	2,64-9,05	Kg	105
mm	80		→
			0
€		****	G= 2

Couleurs disponibles :
 Available colours:

- 50053
Anthracite
Anthracite
- Rouille
Rust



NEW

T-BARBARA C CANALISÉ

POËLE EN ACIER
CHANNELED STEEL STOVE

Dim. : 504 (L) x 505 (P) x 1042 (H) mm



Dim.: 504 (W) x 505 (D) x 1042 (H) mm

3-13	100
80	
	0
*****	2



Attention : Standard : Vitre noire,
 vitre blanche seulement en option
 Be careful: Standard:
 black glass, white glass only option.

Couleurs disponibles :
 Available colours:

-  50053
Anthracite
Anthracite
-  50054
Blanc
White



ADELAIDE

Structure en acier, anthracite ou blanc
 Anthracite or white steel body
 Dim. : 534 (L) x 495 (P) x 1045 (H) mm
 Dim. : 534 (W) x 495 (D) x 1045 (H) mm



ARMELLE

Structure en céramique, angles arrondis
 en acier
 Ceramic body and curved steel corners
 Dim. : 534 (L) x 580 (P) x 1059 (H) mm
 Dim. : 534 (W) x 580 (D) x 1059 (H) mm



Couleurs disponibles pour la céramique :
 Available colours for ceramic:

-  50081
Blanc mat
Mat white
-  50082
Noir star
Glossy black

Attention : Standard : Vitre noire,
 vitre blanche seulement en option
 Be careful: Standard:
 black glass, white glass only option.





BLACKLIGHT

6,5 kW OU 10 kW

Poêle en acier noir ou orange

Black or orange steel stove

Dim. 6,5 Kw : 534 (L) x 508 (P) x 1041 (H) mm

Dim. 6,5 Kw: 534 (W) x 508 (D) x 1041 (H) mm

Dim. 10 Kw : 630 (L) x 622 (P) x 1161 (H) mm

Dim. 10 Kw: 630 (W) x 622 (D) x 1161 (H) mm

Option : Éclairage LED avec variations des couleurs (télécommande)

Option: LED lighting with color variations (remote)

6,5		kw	2,5-6,5	6,5		kg	115	ou	10		kw	3-10	10		kg	165
	80			6,5		kg	18	ou	10		kg	34				
€		*****		G=	2											





TOWER

6,5 kW OU 8 kW

Poêle en acier et pierre blanche ramagée

Steel stove and Fossil-encrusted white stone

Dim. : 545 (L) x 497 (P) x 1069 (H) mm

Dim. : 545 (W) x 497 (D) x 1069 (H) mm

6,5 kW 2,5-6,5 ou 8 kW 2,5-8 202

80 18

***** = 2



STONE

6,5 kW OU 8 kW

Poêle en acier et pierre blanche ramagée

Steel stove and Fossil-encrusted white stone

Dim. : 565 (L) x 514 (P) x 1066 (H) mm

Dim. : 565 (W) x 514 (D) x 1066 (H) mm

6,5 kW 2,5-6,5 ou 8 kW 2,5-8 222

80 18

***** = 2



Couleurs disponibles :
Available colours:

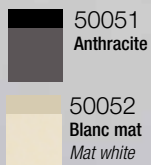

Attention : Standard : Vitre noire,
vitre blanche seulement en option
Be careful: Standard:
black glass, white glass only option.



AMANDINE

Structure en acier, anthracite ou blanc
Anthracite or white steel body
Dim. : 534 (L) x 565 (P) x 1041 (H) mm
Dim. : 534 (W) x 565 (D) x 1041 (H) mm



Couleurs disponibles pour la céramique :
Available colours for ceramic:

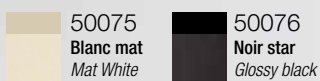

ALEYNA

Structure en céramique, angles arrondis en acier
Ceramic body and curved steel corners
Dim. : 534 (L) x 580 (P) x 1059 (H) mm
Dim. : 534 (W) x 580 (D) x 1059 (H) mm





T-BARBARA
 EN ACIER BLANC
 (TÉLÉCOMMANDE INFRAROUGE)
 STEEL STOVE WITH INFRARED
 REMOTE CONTROL
 Dim. : 504 (L) x 505 (P) x 1042 (H) mm
 Dim.: 504 (W) x 505 (D) x 1042 (H) mm

3-10 kW	92 kg	
80 mm	→	18 kg
		0
€	*****	G= 2



T-BICE
 EN ACIER BLANC
 (TÉLÉCOMMANDE INFRAROUGE)
 STEEL STOVE WITH INFRARED
 REMOTE CONTROL
 Dim. : 586 (L) x 541 (P) x 1042 (H) mm
 Dim.: 586 (W) x 541 (D) x 1042 (H) mm

3-10 kW	92 kg	
80 mm	→	18 kg
		0
€	*****	G= 2



Attention : Standard : Vitre noire,
 vitre blanche seulement en option
 Be careful! Standard:
 black glass, white glass only option.



ANDREA

DESSUS EN CÉRAMIQUE

Structure en acier, angles en céramique
 Steel body, ceramic top and ceramic corners
 Dim. : 617 (L) x 622 (P) x 1161 (H) mm
 Dim.: 617 (W) x 622 (D) x 1161 (H) mm

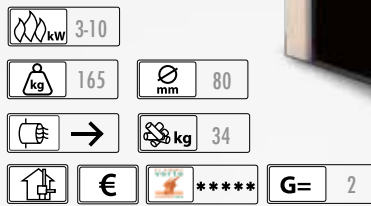

Couleurs disponibles pour la céramique latérale :
 Available colours for ceramic sides:

 50099 Blanc mat Mat white	 50100 Noir star Glossy black	 50101 Bordeaux brillant Glossy Bordeaux
---	--	---

ALMA

Finition : céramique (côtés et dessus)
 Finishing: ceramic (body and top)
 Dim. : 630 (L) x 622 (P) x 1161 (H) mm
 Dim.: 630 (W) x 622 (D) x 1161 (H) mm



Convection forcée
 Forced convection

SILENCE
 +

Sauf 10 kW
 except 10 kW

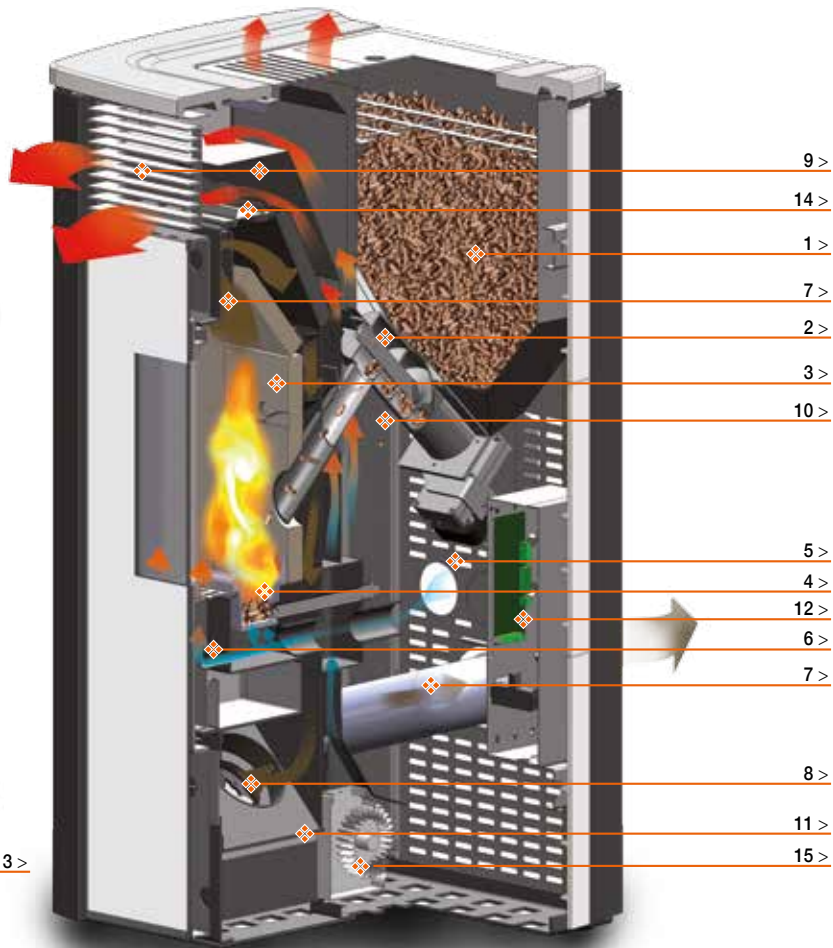

- 1> Réservoir à granulés *Pellet tank*
- 2> Système d'alimentation automatique en acier
Automatic pellet fuel feeding system 100% steel
- 3> Vermiculite *Vermiculite*
- 4> Creuset en fonte *Cast-iron crucible*
- 5> Entrée d'air de combustion *Combustion air inlet*
- 6> Entrée d'air secondaire *Secondary air inlet*
- 7> Evacuation des fumées *Smoke evacuation*
- 8> Extracteur de fumées *Smoke exhauster*
- 9> Circuit et sortie d'air chaud (convection naturelle ou forcée) *Warm air vents (Natural or forced convection)*
- 10> Sonde de température *Temperature probe*
- 11> Zone d'extraction des fumées *Smoke extraction area*

- 12> Système électronique avec microprocesseur permettant la gestion de l'appareil à distance par la télécommande ou manuellement si besoin
Electronic system with microprocessor which enables to manage the appliance with a remote control or manually when needed
- 13> Télécommande radio ou infra-rouge* avec sonde de température intégrée *Radio or ir* remote control with temperature probe*
- 14> Clapet anti-surpression *Anti-overpressure valve*
- 15> A6-A8 : Ventilateur de convection 250 m³/h
A10: Ventilateur de convection 720 m³/h
A6-A8: Convection fan 250 m³/h
A10: Convection fan 720 m³/h

* Selon modèles

* depending on models



GAMME A6 A8 A10 Sauf produits étanches (except airtight products)	A6 MAX	A8 MAX	A10 MAX	MIN	
				A6 - A8	A10
Puissance thermique <i>Thermal output</i>	6,5 kW	8,0 kW	10,0 kW	2,5 kW	3 kW
Rendement énergétique <i>Efficiency</i>	89 %	87,0 %	85,0 %	88,5 %	88,5 %
Consommation horaire <i>Hourly consumption</i>	1,54 kg/h	1,97 kg/h	2,50 kg/h	0,57 kg/h	0,72 kg/h
Autonomie <i>Autonomy</i>	12 h env.	9 h env.	14 h env.	31,5 h env.	25 h env.
Capacité du réservoir <i>Tank capacity</i>	18 kg	18 kg	34 kg	18 kg	
Taux de monoxyde de carbone (CO à 13% O₂) <i>CO emission at 13% of O₂</i>	0,017	0,021	0,017	0,023	0,045
Débit massique des fumées <i>Flue gas mass flow</i>	6,24 g/s	7,20 g/s	13,24 g/s	4,20 g/s	-
Température moyenne des fumées <i>Average flue gas temperature</i>	171 °C	213 °C	166 °C	118 °C	102 °C
Pression négative <i>Negative pressure</i>	11 Pa	12 Pa	12 Pa	12 Pa	
Puissance électrique maximal (allumage 20 min) <i>Maximum electrical consumption (startup 20 min)</i>	350 W	400 W	400 W		
Consommation électrique horaire <i>Hourly electrical consumption</i>	72-117 W / h	51-109 W / h	51-126 W / h	-	
Raccordement arrière pour l'évacuation des fumées <i>Flue gas exit back connexion</i>	Ø 80 mm				
Diamètre de raccordement pour l'entrée d'air de combustion <i>Air inlet connexion Ø</i>	Ø 80 mm				
Réglage et fonctionnement par <i>Adjustement and functioning by</i>	Télécommande infrarouge ou radio <i>IR or Radio remote control</i>				
Cendrier (tiroir à cendres) <i>Ashtray (Ash drawer)</i>	Amovible <i>Removable</i>				

Certifications *Certifications :*



EN 14785

Normes Européennes pour les appareils à pellets / *European standards for pellet appliances*

BlmSchV

Amendement allemand concernant les émissions / *German amendment regarding emissions*

Compatible / *Conforme*
15a B-VG

Norme fédérale autrichienne - art. 15a / *Austrian federal standard : art. 15a*



Available colours for ceramic corners:

	50093 Blanc mat Mat white		50094 Noir star Glossy black
--	---------------------------------	--	------------------------------------



AGATHA CANALISÉ

Structure en acier, dessus et angles en céramique

Steel body, ceramic top and corners

Convection forcée frontale et/ou 2 sorties arrières

Forced convection with 2 back exits

Dim. : 617 (L) x 622 (P) x 1161 (H) mm

Dim.: 617 (W) x 622 (D) x 1161 (H) mm



Couleurs disponibles pour la céramique :

Available colours for ceramic:

	50099 Blanc White		50100 Noir star Glossy black		50101 Bordeaux Bordeaux
---	-------------------------	---	------------------------------------	---	-------------------------------

Attention : Standard : Vitre noire,
vitre blanche seulement en option

Be careful: Standard:
black glass, white glass only option.

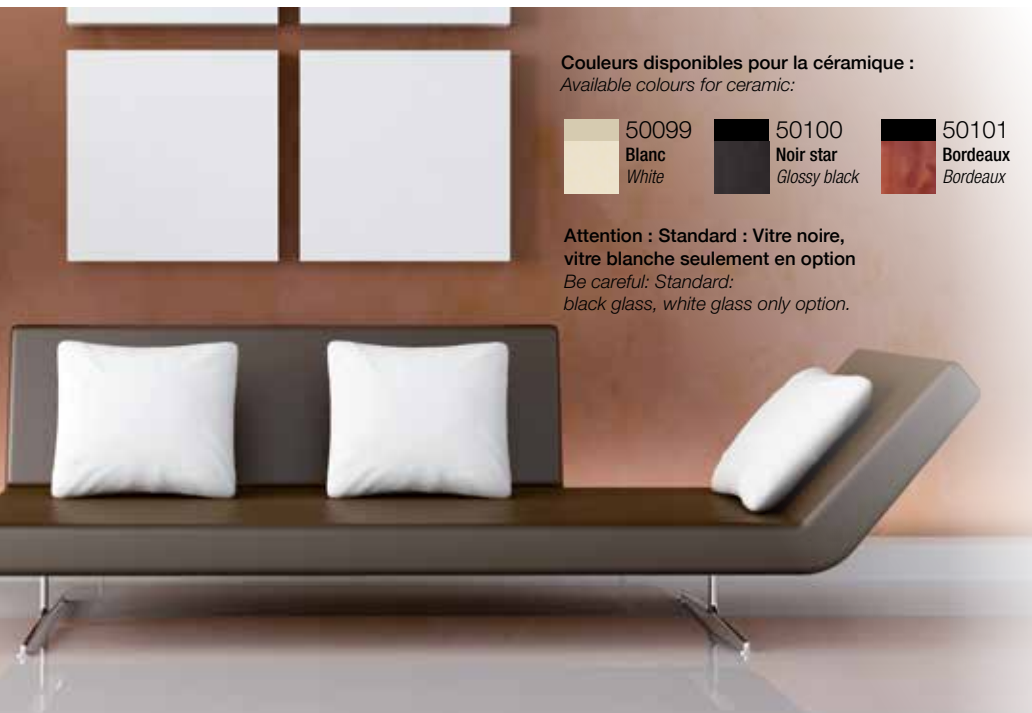

AMBRE CANALISÉ

Finition : céramique (côtés et dessus)

Finishing: ceramic (body and top)

Dim. : 630 (L) x 662 (P) x 1161 (H) mm

Dim.: 630 (W) x 662 (D) x 1161 (H) mm

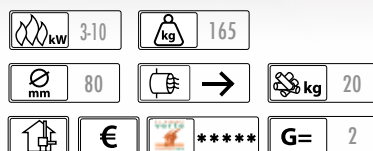



Couleurs disponibles pour la céramique :
Available colours for ceramic:

50111
Blanc mat
Mat white

50112
Noir star
Glossy black

50113
Bordeaux brillant
Glossy Bordeaux

Attention : Standard : Vitre noire,
vitre blanche seulement en option
Be careful: Standard:
black glass, white glass only option.

ANNA CANALISÉ

Finition : céramique (côtés et dessus)

Finishing: ceramic (body and top)

Convection forcée frontale et/ou 2 sorties arrières

Forced convection with 2 back exits

Dim. : 633 (L) x 622 (P) x 1161 (H) mm

Dim.: 633 (W) x 622 (D) x 1161 (H) mm



ALIZÉE CANALISÉ

Structure en acier, dessus en céramique et angles en céramique

Steel body, ceramic top and ceramic corners

Convection forcée frontale et/ou 2 sorties arrières

Forced convection with 2 back exits

Dim. : 617 (L) x 622 (P) x 1161 (H) mm

Dim.: 617 (W) x 622 (D) x 1161 (H) mm



Couleurs disponibles pour les angles en céramique :
Available colours for ceramic corners:

50105
Blanc mat
Mat white

50106
Noir star
Glossy black

Convection forcée avec 1 sortie frontale ou 2 sorties arrière
 Forced convection with 1 front exit or 2 back exits

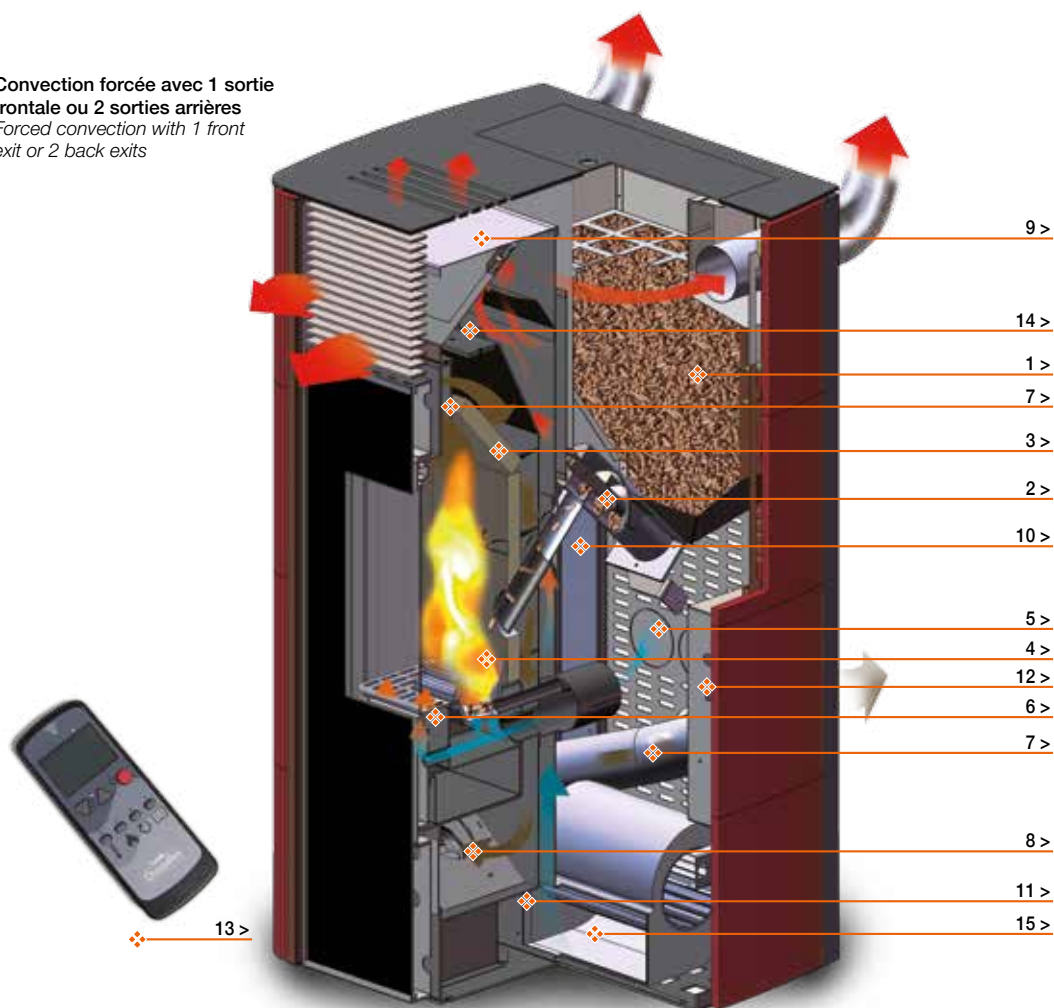

- 1> Réservoir à granulés *Pellet tank*
- 2> Système d'alimentation automatique *Automatic pellet fuel feeding system 100% steel*
- 3> Vermiculite *Vermiculite*
- 4> Creuset en fonte *Cast-iron crucible*
- 5> Entrée d'air de combustion *Combustion air inlet*
- 6> Entrée d'air secondaire *Secondary air inlet*
- 7> Evacuation des fumées *Smoke evacuation*
- 8> Extracteur de fumées *Smoke exhauster*
- 9> Circuit et sortie d'air chaud (convection naturelle ou forcée) *Warm air vents (Natural or forced convection)*
- 10> Sonde de température *Temperature probe*

- 11> Zone d'extraction des fumées *Smoke extraction area*
- 12> Système électronique avec microprocesseur permettant la gestion de l'appareil à distance par la télécommande ou manuellement si besoin *Electronic system with microprocessor which enables to manage the appliance with a remote control or manually when needed*
- 13> Télécommande radio avec sonde de température intégrée *Radio remote control with temperature probe*
- 14> Clapet anti-surpression *Anti-overpressure valve*
- 15> Ventilateur de convection 720 m³/h *Convection fan 720 m³/h*



GAMME 10-13 kW	A10C MAX	A13C MAX	MIN
Puissance thermique <i>Thermal output</i>	10 kW	13,0 kW	3 kW
Rendement énergétique <i>Efficiency</i>	85 %	83,0 %	85,5 %
Consommation horaire <i>Hourly consumption</i>	2,50 kg/h	3,25 kg/h	0,72 kg/h
Autonomie <i>Autonomy</i>	8 h env.	6 h env.	27 h env.
Capacité du réservoir <i>Tank capacity</i>	20 kg	20 kg	20 kg
Taux de monoxyde de carbone (CO à 13% O₂) <i>CO emission at 13% of O₂</i>	0,017 %	0,025%	0,045 %
Débit massique des fumées <i>Flue gas mass flow</i>	13,24 g/s	14,85 g/s	7,30 g/s
Température moyenne des fumées <i>Average flue gas temperature</i>	166 °C	211 °C	102° C
Pression négative <i>Negative pressure</i>	12 Pa	12 Pa	11 Pa
Puissance électrique maximal <i>Maximum electrical consumption</i>	400 W (Allumage / Start-up) 20 min		
Consommation électrique horaire <i>Hourly electrical consumption</i>	51-126 W / h		
Raccordement arrière pour l'évacuation des fumées <i>Flue gas exit back connexion</i>	Ø 80 mm		
Diamètre de raccordement pour l'entrée d'air de combustion <i>Air inlet connexion Ø</i>	Ø 80 mm		
Réglage et fonctionnement par <i>Adjustement and functioning by</i>	Télécommande infrarouge ou radio <i>IR or Radio remote control</i>		
Cendrier (tiroir à cendres) <i>Ashtray (Ash drawer)</i>	Amovible <i>Removable</i>		

Certifications Certifications :



EN 14785

Normes Européennes pour les appareils à pellets / *European standards for pellet appliances*

BImSchV

Amendement allemand concernant les émissions / *German amendment regarding emissions*

Compatible / *Conforme*

15a B-VG

Norme fédérale autrichienne - art. 15a / *Austrian federal standard : art. 15a*



Les poêles à bois

WOOD STOVES





NEW

THORENS

POÊLE EN FONTE
CAST-IRON STOVE

Dim. : 470 (L) x 980 (H) x 360 (P) mm

Dim.: 470 (W) x 980 (H) x 360 (D) mm

kW 7-9	kg 125
mm 150	↑
	0
€ *****	G= 5













NEW

GELA

POÊLE EN ACIER
STEEL STOVE

Dim. : 494 (L) x 1103 (H) x 473 (P) mm
Dim.: 494 (W) x 1103 (H) x 473 (D) mm

 kw 4,5-8	 kg 142	
 mm 150	 ↑	
	 0	
 €	 *****	 G= 2











NEW

LIADO

POËLE EN ACIER FINITION PIERRE
STEEL STOVE WITH STONE FINISH

Dim. : 568 (L) x 1130 (H) x 499 (P) mm
Dim.: 568 (W) x 1130 (H) x 499 (D) mm

 kW 4,5-8	 220
 150	 ↑
	 0
€  *****	G= 2





EQUINOXE

Poêle en fonte *Cast iron stove*
Dim. : 515 (L) x 1140 (H) x 430 (P) mm
Dim. : 515 (W) x 1140 (H) x 430 (D) mm
Post combustion

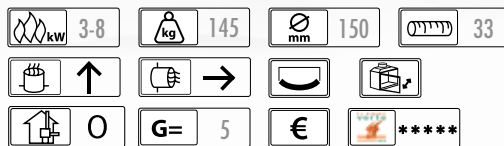

SOLSTICE

Poêle en fonte *Cast iron stove*
Dim. : 515 (L) x 1140 (H) x 420 (P) mm
Dim. : 515 (W) x 1140 (H) x 420 (D) mm
Post combustion

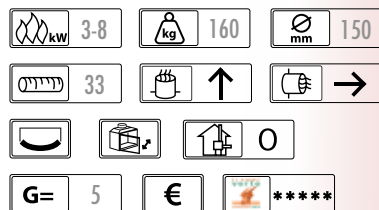



MODERN
 ANTHRACITE
 ANTRACITE

Poêle en fonte *Cast iron stove*
 Dim. : 760 (L) x 570 (P) x 830 (H) mm
 Dim.: 760 (W) x 570 (D) x 830 (H) mm
 Post combustion

4-11 kW	210 kg	60 mm	150 mm
G= 5	€	****	



MODERN
 ÉMAILLÉ BLANC OU NOIR
 WHITE OR BLACK ENAMEL
 FINISH

Poêle en fonte *Cast iron stove*
 Dim. : 760 (L) x 570 (P) x 830 (H) mm
 Dim.: 760 (W) x 570 (D) x 830 (H) mm
 Post combustion

4-11 kW	210 kg	60 mm
150 mm		
€	****	G= 5



ACTUAL

ANTHRACITE

ANTRACITE

Poêle en fonte *Cast iron stove*

Dim. : 555 (L) x 440 (P) x 740 (H) mm

Dim.: 555 (W) x 440 (D) x 740 (H) mm

Post combustion

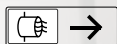
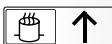
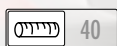
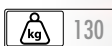
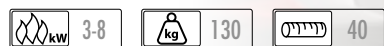

0





5



Coloris : blanc, noir émaillé

Colours: white, black enamel finishing



NEO

ANTHRACITE

ANTRACITE

Poêle en fonte *Cast iron stove*

Dim. : 525 (L) x 475 (P) x 830 (H) mm

Dim.: 525 (W) x 475 (D) x 830 (H) mm

Post combustion

Poignée amovible *Removable handle*

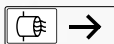
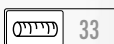
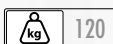
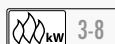



5





RUSTIQUE

ANTHRACITE
ANTRACITE

Poêle en fonte *Cast iron stove*
Dim. : 780 (L) x 580 (P) x 800 (H) mm
Dim.: 780 (W) x 580 (D) x 800 (H) mm
Post combustion

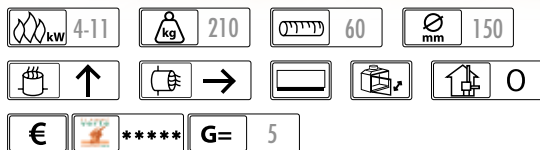

RUSTIQUE

IVOIRE ÉMAILLÉ
IVORY ENAMEL FINISHING

Poêle en fonte *Cast iron stove*
Dim. : 780 (L) x 580 (P) x 800 (H) mm
Dim.: 780 (W) x 580 (D) x 800 (H) mm
Post combustion





ARDIDEN (NOIR)

POÊLE EN ACIER NOIR
BLACK STEEL STOVE

Dim. : 470 (Ø) x 1508 (H) mm

Dim.: 470 (Ø) x 1508 (H) mm

Post combustion

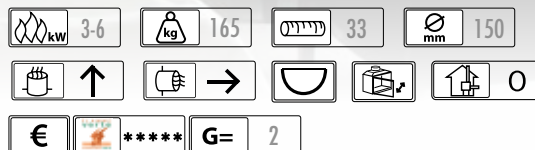

Option : kit accumulateur de chaleur
Option: heat accumulator kit

ARDIDEN (INOX)

POÊLE EN INOX
STEEL STOVE

Dim. : 470 (Ø) x 1508 (H) mm

Dim.: 470 (Ø) x 1508 (H) mm

Post combustion

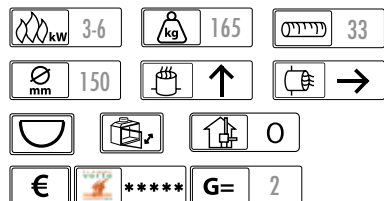



AVORIAZ

Poêle en acier *Steel stove*

Dim. : Ø 470 x 1100 (H)

Dim.: Ø 470 x 1100 (H)

Post combustion

kW	3-6	kg	120	mm	150
	33				
			90°		0
	2		€		*****





CHAMONIX

avec fixation murale
 with wall fixation

Poêle en acier Steel stove

Dim. : 452 (L) x 405 (P) x 730 (H) mm

Dim. : 452 (W) x 405 (D) x 730 (H) mm

Post combustion

kw 2,5-5	kg 115	mm 150	mm 33
G= 2	€	*****	



CHAMONIX

Poêle en acier Steel stove

Dim. : 452 (L) x 405 (P) x 1066 (H) mm

Dim. : 452 (W) x 405 (D) x 1066 (H) mm

Post combustion

kw 2,5-5	kg 100	mm 150
mm 33		
		0
G= 2	€	*****





MEGEVE (BLANC)

POÊLE EN ACIER ET
CÉRAMIQUE BLANCHE
STEEL STOVE WITH WHITE
CERAMIC FINISH

Dim. : 568 (L) x 499 (P) x 1130 (H) mm
Dim.: 568 (W) x 499 (D) x 1130 (H) mm

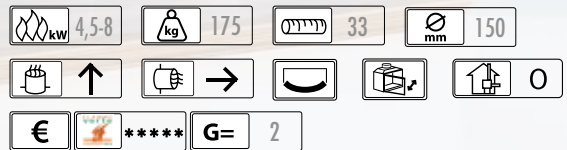

MEGEVE (NOIR)

POÊLE EN ACIER ET
GRANIT NOIR
STEEL STOVE WITH BLACK
GRANITE FINISH

Dim. : 568 (L) x 499 (P) x 1130 (H) mm
Dim.: 568 (W) x 499 (D) x 1130 (H) mm





MORZINE

POÊLE EN ACIER
STEEL STOVE

Dim. : 495 (L) x 486 (P) x 1105 (H) mm

Dim.: 495 (W) x 486 (D) x 1105 (H) mm

Post combustion

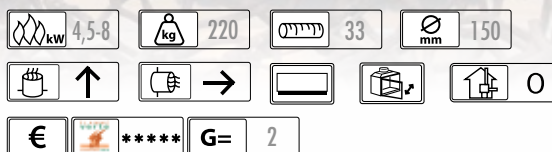

ST MORITZ

POÊLE EN ACIER ET PIERRE
STEEL STOVE WITH STONE
FINISH

Dim. : 791 (L) x 504 (P) x 1105 (H) mm

Dim.: 791 (W) x 504 (D) x 1105 (H) mm

Post combustion

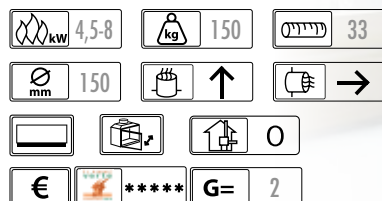

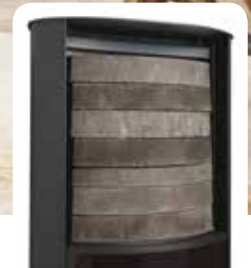

Option : kit accumulateur
de chaleur
Option: heat accumulator kit

COURCHEVEL

Poêle en acier *Steel stove*
Dim. : 536 (L) x 474 (P) x 1605 (H) mm
Dim.: 536 (W) x 474 (D) x 1605 (H) mm
Post combustion

 3,2-6,4	 146	 150	 33
 ↑	 →		 0
G= 2	€	 *****	



Les poêles en pierres ollaires

SOAPSTONES STOVES



Un chauffage par rayonnement

Une des qualités uniques de la pierre ollaire est sa capacité à accumuler et stocker très rapidement toute la chaleur accumulée avant de la diffuser très lentement, même feu éteint. Un poêle en pierre ollaire offre également une grande sécurité.

La sobriété des lignes et le coloris naturel de la pierre ollaire met en valeur le cœur de ces poêles qui ont fait leur réputation dans les pays nordiques.

Pour l'ensemble de ces poêles, le raccordement se fait par le dessus.

Radiant heating

One of the unique qualities of soapstone is its ability to very rapidly accumulate and store all of the generated heat and then release it very slowly, even after the fire is extinguished. A soapstone stove is also very safe. The simplicity of the lines and the natural color of the soapstone set off perfectly the heart of these stoves, which have a proven reputation in Northern countries.

For all of these stoves the connection is made from above.



PARIS 8 HP 530

Dim : 760 (L) x 1460 (H) x 540 (P) mm
 Diamètre : Ø 15 cm
 Dim : 760 (W) x 1460 (H) x 540 (D) mm
 Flue pipe diameter: Ø 15 cm



RAVENA

Charges journalières conseillées : 3
 Consommation moyenne de bois par heure de chauffage : 2 kg/h
 Charge totale maximale autorisée par jour : 50 kg
 Dimension chambre de combustion : 500 (L) x 300 (H) x 300 (P) mm
 Dim : 800 (L) x 1360 (H) x 500 (P) mm
 Diamètre du tube de fumée : Ø 15 cm

Recommended loads per day: 3
 Average wood consumption per hour of heating: 2 kg/h
 Maximum total load permitted per day: 50 kg
 Combustion chamber dimensions: 500 (W) x 300 (H) x 300 (D) mm
 Dim: 800 (W) x 1360 (H) x 500 (D) mm
 Flue pipe diameter: Ø 15 cm

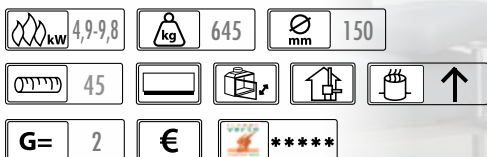

ASSISI C700

Charges journalières conseillées : 3
 Consommation moyenne de bois par heure de chauffage : 2 kg/h
 Charge totale maximale autorisée par jour : 50 kg
 Dimension chambre de combustion : 590 (L) x 400 (H) x 330 (P) mm
 Dim : 980 (L) x 1320 (H) x 660 (P) mm
 Diamètre du tube de fumée : Ø 20 cm

Recommended loads per day: 3
 Average wood consumption per hour of heating: 2 kg/h
 Maximum total load permitted per day: 50 kg
 Combustion chamber dimensions: 590 (W) x 400 (H) x 330 (D) mm
 Dim: 980 (W) x 1320 (H) x 660 (D) mm
 Flue pipe diameter: Ø 20 cm



Les cheminées métal

METALLIC FIREPLACES

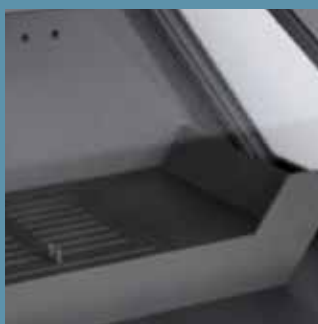
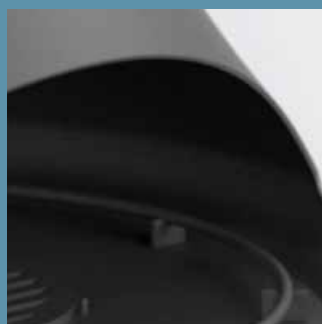



NEW







HYPE L

Dim. : 1250 (Ø) x 2700 (H) mm

Dim.: 1250 (Ø) x 2700 (H) mm

Coloris : inox, couleurs RAL

Colours : stainless-steel, RAL colours

 kW	16	 kg	210
 mm	250		
			
€	G=	2	



Bois
Wood





NEW

HYPE S

Dim. : 506 (Ø) x 2700 (H) mm

Dim.: 506 (Ø) x 2700 (H) mm

Coloris : inox, couleurs RAL

Colours : stainless-steel, RAL colours

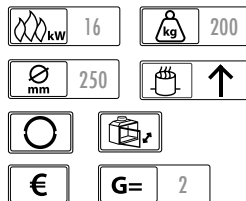

Bois
Wood





NEW

FROG

Dim. : 1200 (L) x 900 (P) x 2300 (H) mm
 Dim.: 1200 (W) x 900 (D) x 2300 (H) mm
 Coloris : noir, gris
 Colours: black, grey

 8,9

 160



 220



Bois
Wood

G= 2





NEW

VINKLE

Dim. : 990 (L) x 541 (P) x 2300 (H) mm

Dim. : 990 (W) x 541 (D) x 2300 (H) mm

Coloris : noir, gris

Colours : black, grey

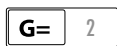
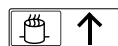
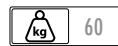

Bois
Wood

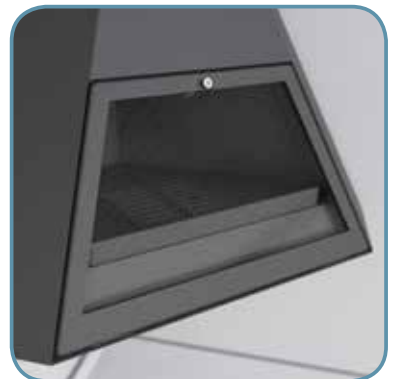

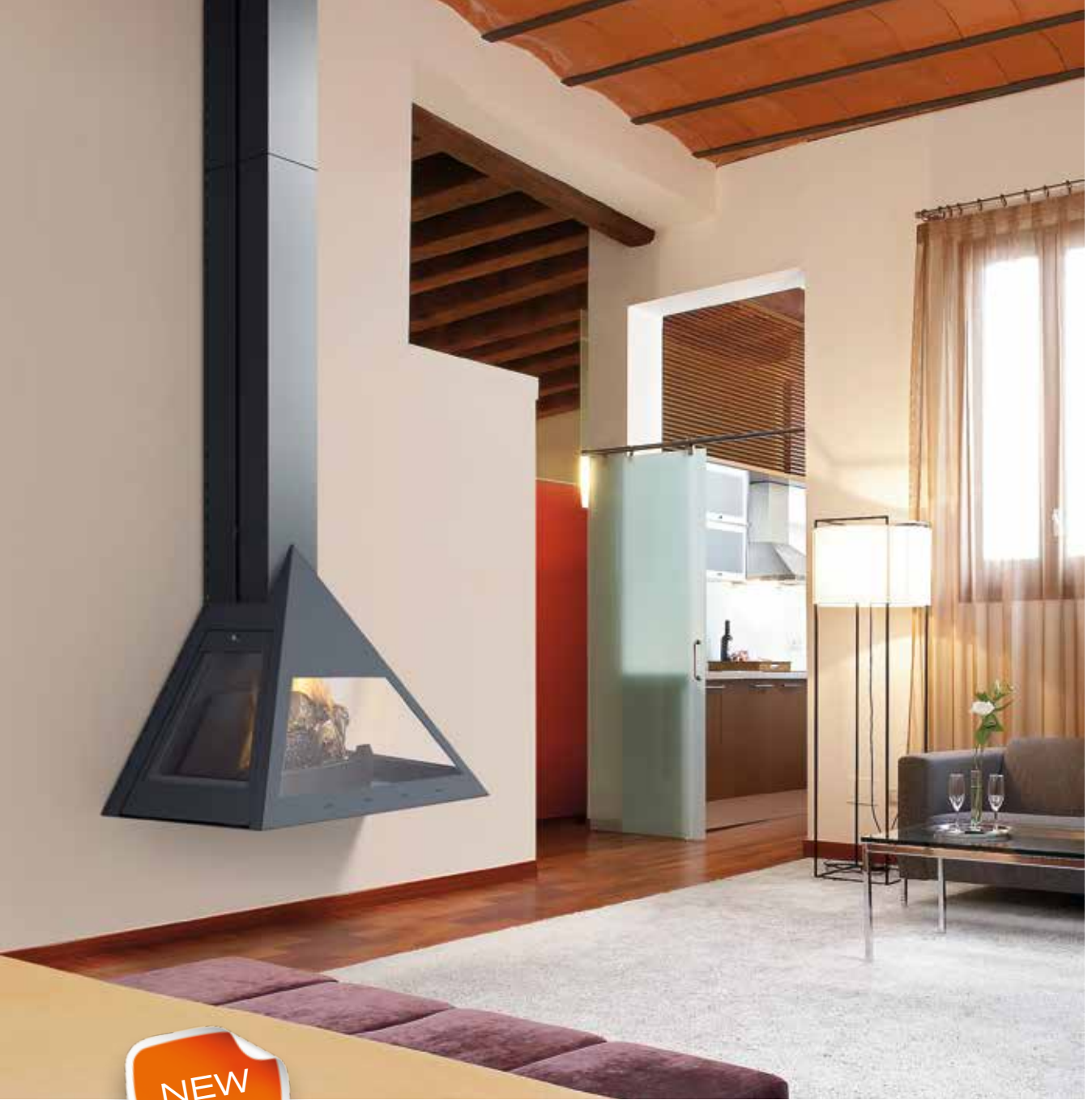

NEW









KYLEN

Dim. : 993,6 (L) x 690,8 (P) x 2300 (H) mm

Dim.: 993,6 (W) x 690,8 (D) x 2300 (H) mm

Coloris : noir, gris

Colours : black, grey

 12,2	 130
 200	 ↑
	
 €	 G= 2



Bois
Wood





CUBE 70

Cheminée-Poêle modulaire en acier.
Options : module(s) supplémentair(es).
Metallic fireplace.
Options : additional module(s).
Dim. : 1458 (L) x 510 (P) x 1066 (H) mm
Dim. : 1458 (W) x 510 (D) x 1066 (H) mm



SINGAPOUR GRANULÉS PELLETS

Cheminée-Poêle en acier
Metallic fireplace
Dim. : 1553 (L) x 660 (P) x 1290 (H) mm
Dim. : 1553 (W) x 660 (D) x 1290 (H) mm





SINGAPOUR

BOIS WOOD

Cheminée-Poêle en acier

Metallic fireplace

Dim. : 1553 (L) x 660 (P) x 1290 (H) mm

Dim.: 1553 (W) x 660 (D) x 1290 (H) mm

Post combustion

5-10	310	200
50	↑	↑
G= 2	€	****



NOMAD HP 530

Cheminée-Poêle en acier

Metallic fireplace

Dim. : 720 (L) x 525 (P) x 1196 (H) mm

Dim.: 720 (W) x 525 (D) x 1196 (H) mm

Coloris : chocolat, blanc

Colours: chocolate, white

Post combustion

3,5-7	220	150
33	↑	↑
0	G= 2	€ ****





CUBO 60

Cheminée-Poêle modulaire en acier avec niche à bois.
Options : module(s) supplémentair(es) et plateau(x) pierre ollaire.

Metallic fireplace with wood niche.

Options : additional module(s) and soapstone tray(s).

Dim. : 600 (L) x 403 (P) x 965 (H) mm

Dim.: 600 (W) x 403 (D) x 965 (H) mm



CUBO 70

Cheminée-Poêle modulaire en acier avec niche à bois.
Options : module(s) supplémentair(es) et plateau(x) pierre ollaire.

Metallic fireplace with wood niche.

Options : additional module(s) and soapstone tray(s).

Dim. : 700 (L) x 403 (P) x 965 (H) mm

Dim.: 700 (W) x 403 (D) x 965 (H) mm





CUBO 80

Cheminée-Poêle modulaire en acier avec niche à bois.
Options : module(s) supplémentair(es) et plateau(x) pierre ollaire.

Metallic fireplace with wood niche.

Options : additional module(s) and soapstone tray(s).

Dim. : 800 (L) x 403 (P) x 965 (H) mm

Dim.: 800 (W) x 403 (D) x 965 (H) mm

6,2-12,5 kW	142 kg	180 mm
50		
		G= 2
		€



COLIBRI

ANTHRACITE ANTRACITE

Cheminée-Poêle en acier

Metallic fireplace

Dim. : 855 (L) x 505 (P) x 1005 (H) mm

Dim.: 855 (W) x 505 (D) x 1005 (H) mm

4,7-9,5 kW	188 kg	200 mm
50		
	G= 2	€



Les inserts granulés

PELLET INSERTS





NEW

FACEL 800 3V

Dim. : 800 (L) x 732 (P) x 1456 (H) mm
 Dim.: 800 (W) x 732 (D) x 1456 (H) mm

kW	5,1-14	kg	150
mm	100		→
			0
€		****	G= 2













NEW

FACEL 800 VAG / VAD

Dim. : 797 (L) x 732 (P) x 1456 (H) mm
 Dim.: 797 (W) x 732 (D) x 1456 (H) mm

 kw	5,1-14	 kg	150
 mm	100		→
 ou 			0
€	 ****	G=	2



FACEL 500



Dim. : 766 (L) x 425 (P) x 1335 (H) mm
 Dim.: 766 (W) x 425 (D) x 1335 (H) mm



FACEL 800



Dim. : 858 (L) x 619 (P) x 1445 (H) mm
 Dim.: 858 (W) x 619 (D) x 1445 (H) mm





FACEL 1000

Dim. : 1058 (L) x 619 (P) x 1445 (H) mm
 Dim.: 1058 (W) x 619 (D) x 1445 (H) mm

5,1-14 kW	162 kg
100 mm	→
	0
€ *****	G= 2



	FACEL 800 3V / VAD / VAG		FACEL 500		FACEL 800		FACEL 1000	
	Max	Min	Max	Min	Max	Min	Max	Min
Puissance thermique <i>Thermal output</i>	14 kW	5,1 kW	10 kW	3 kW	14 kW	5,1 kW	14 kW	5,1 kW
Rendement énergétique <i>Efficiency</i>	85 %	88,5 %	85 %	85,5 %	85 %	88,5 %	85,0 %	88,5 %
Consommation horaire <i>Hourly consumption</i>	3,5 kg/h	1,02 kg/h	2,50 kg/h	0,72 kg/h	3,5 kg/h	1,02 kg/h	3,5 kg/h	1,2 kg/h
Autonomie <i>Autonomy</i>	22 h env.	63 h env.	24 h env.	83 h env.	22 h env.	63 h env.	26 h env.	75 h env.
Capacité du réservoir <i>Tank capacity</i>	76	76	60 kg	60 kg	76 kg	76 kg	90 kg	90 kg
Taux de monoxyde de carbone (CO à 13% O ₂) <i>CO emission at 13% of O₂</i>	0,020	0,017	0,017	0,045	0,020	0,017	0,020	0,017
Débit massique des fumées <i>Flue gas mass flow</i>	14,3 g/s	8 g/s	13,24 g/s	7,30 g/s	14,3 g/s	8 g/s	14,3 g/s	8 g/s
Température moyenne des fumées <i>Average flue gas temperature</i>	190 °C	106 °C	166 °C	102 °C	190 °C	106 °C	190 °C	106 °C
Pression négative <i>Negative pressure</i>	10 Pa	12 Pa	12 Pa	11 Pa	10 Pa	12 Pa	10 Pa	12 Pa
Raccordement arrière pour l'évacuation des fumées <i>Flue gas exit back connexion</i>	Ø 100 mm		Ø 80 mm		Ø 100 mm		Ø 100 mm	
Diamètre de raccordement pour l'entrée d'air de combustion <i>Air inlet connexion Ø</i>	Ø 80 mm		Ø 80 mm		Ø 80 mm		Ø 80 mm	
Réglage et fonctionnement par <i>Adjustement and functioning by</i>	Télécommande infrarouge ou radio <i>IR or Radio remote control</i>							
Cendrier (tiroir à cendres) <i>Ashtray (Ash drawer)</i>	Amovible <i>Removable</i>							

Certifications *Certifications :*



EN 14785

Normes Européennes pour les appareils à pellets / European standards for pellet appliances

BImSchV

Amendement allemand concernant les émissions / German amendment regarding emissions

Compatible / Conforme

15a B-VG

Norme fédérale autrichienne - art. 15a / Austrian federal standard : art. 15a



ZEPHYR 70



Dim. : 695 (L) x 500 (P) x 493 (H) mm

Dim.: 695 (W) x 500 (D) x 493 (H) mm

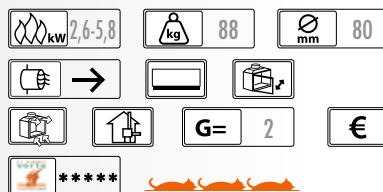

ZEPHYR 80



Dim. : 795 (L) x 500 (P) x 582 (H) mm

Dim.: 795 (W) x 500 (D) x 582 (H) mm



	ZEPHYR 70		ZEPHYR 80	
	Max	Min	Max	Min
Puissance thermique <i>Thermal output</i>	5,8 kW	2,6 kW	9 kW	4,4 kW
Rendement énergétique <i>Efficiency</i>	85 %	86,5 %	85 %	82 %
Consommation horaire <i>Hourly consumption</i>	1,39 kg/h	0,61 kg/h	2,27 kg/h	1,09 kg/h
Autonomie <i>Autonomy</i>	8 h env.	18 h env.	8 h env.	16 h env.
Capacité du réservoir <i>Tank capacity</i>	11 kg	11 kg	18 kg	18 kg
Taux de monoxyde de carbone (CO à 13% O₂) <i>CO emission at 13% of O₂</i>	0,018	0,023	0,021	0,043
Débit massique des fumées <i>Flue gas mass flow</i>	5,57 g/s	3,23 g/s	8,29 g/s	6,60 g/s
Température moyenne des fumées <i>Average flue gas temperature</i>	216 °C	154 °C	230 °C	165 °C
Pression négative <i>Negative pressure</i>	11 Pa	11 Pa	12 Pa	11 Pa
Raccordement arrière pour l'évacuation des fumées <i>Flue gas exit back connexion</i>	Ø 80 mm			
Diamètre de raccordement pour l'entrée d'air de combustion <i>Air inlet connexion Ø</i>	Ø 80 mm			
Réglage et fonctionnement par <i>Adjustement and functioning by</i>	Télécommande infrarouge <i>IR remote control</i>			
Cendrier (tiroir à cendres) <i>Ashtray (Ash drawer)</i>	Amovible <i>Removable</i>			

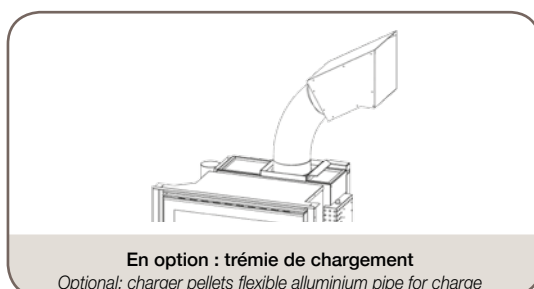

Certifications *Certifications :*



EN 14785

Normes Européennes pour les appareils à pellets / *European standards for pellet appliances*

BImSchV

Amendement allemand concernant les émissions / *German amendment regarding emissions*

Compatible / *Conforme*

15a B-VG

Norme fédérale autrichienne - art. 15a / *Austrian federal standard : art. 15a*



Les inserts bois en fonte

CAST IRON WOOD INSERTS





NEW

F70L

Dim. : 698 (L) x 439 (P) x 638 (H) mm
 Dim.: 698 (W) x 439 (D) x 638 (H) mm
 Post combustion

 4,5-9,5 	 113 	 200 
 50	 	 
 ****	G= 10	 



Cosmopolite

LES INSERTS FULL HP[®]

HP INSERTS



EXIGEZ LA NORME FULL HP[®] ET FAITES LE CHOIX D'UN
INSERT HAUTE PERFORMANCE POUR VOTRE HABITAT.

REQUIRE NORM FULL HP AND MAKE THE CHOICE OF A HIGH PERFORMANCE
INSERT FOR YOUR HOME.

• Haute performance et haut rendement
énergétique

• Modulation de la puissance thermique en
fonction des besoins énergétiques du logement

• Convient aux exigences des maisons BBC
(Bâtiment Basse Consommation)

• Réduction des émissions de polluants

• High performance and high efficiency

• Adjustment of thermal power to your household's
energy needs

• Adapted to the requirements of LCBs (Low Consumption
Buildings)

• Reduction of pollutant emissions

• Réglage facile de la combustion

• Entretien facile

• Glass Protect System[®]

• **GARANTIE BIEN-ÊTRE 10 ANS**

• Easy regulation of combustion

• Easy maintenance

• Glass Protect System[®]

• **10 YEARS WELL BEING WARRANTY**



FLAMME VERTE

HP530

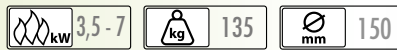

Zen

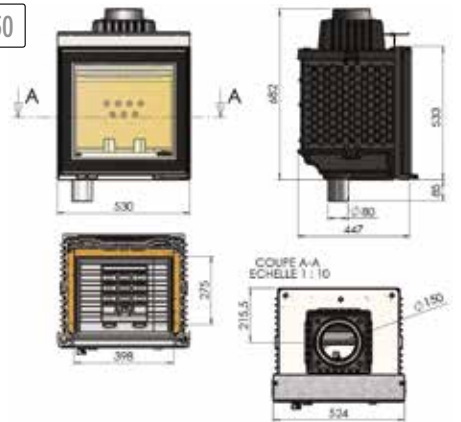

HP700

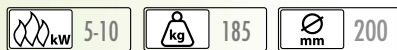

Opus

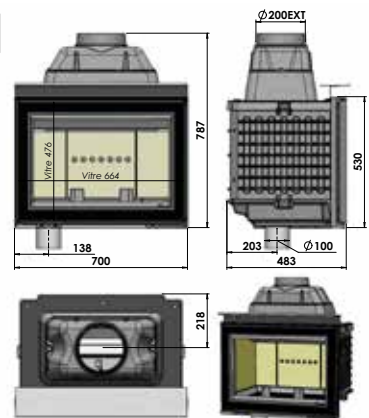

HP800

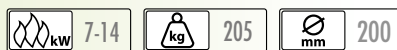

Seattle

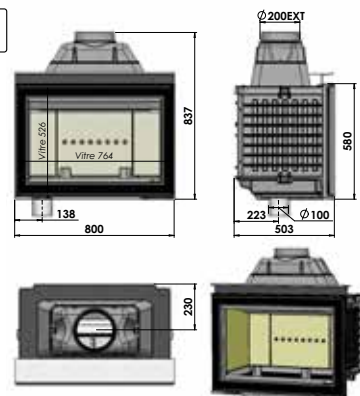

C700L



kw 5,5-10,5	kg 130
G= 10	€ ****



Oloron

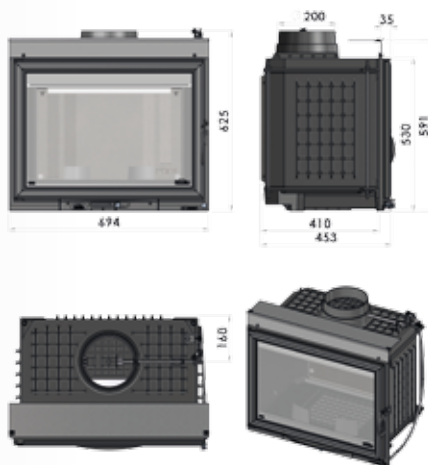

C700R VE



kw 5,5-10,5	kg 185
G= 10	€ ****

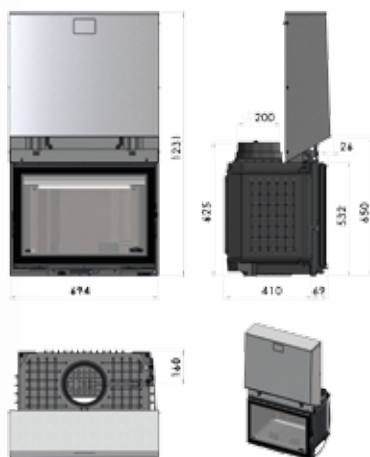

CP700L



kw 5,5-10,5	kg 120
G= 10	€ ****



Villemallet

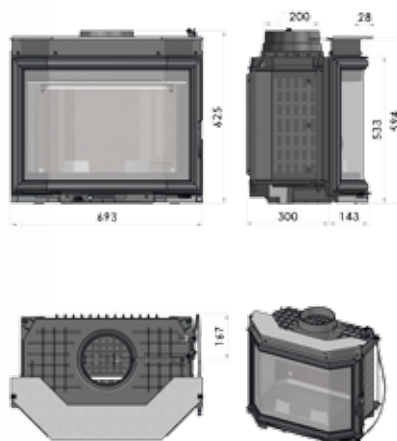

CP700R

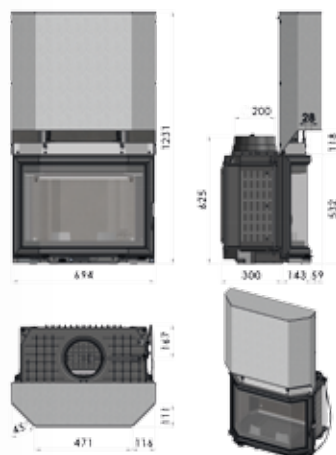

C800L



City



C800RVE

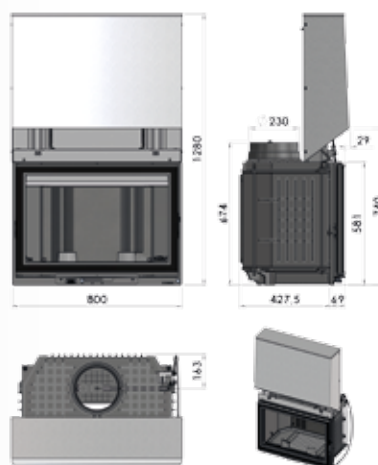
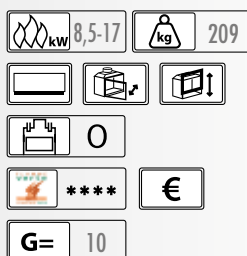

CG800L



kW 8,5-17	kg 158
G= 10	€ ****



Montprimblanc



CG800R



kW 8,5-17	kg 224	
G= 10	€ ****	

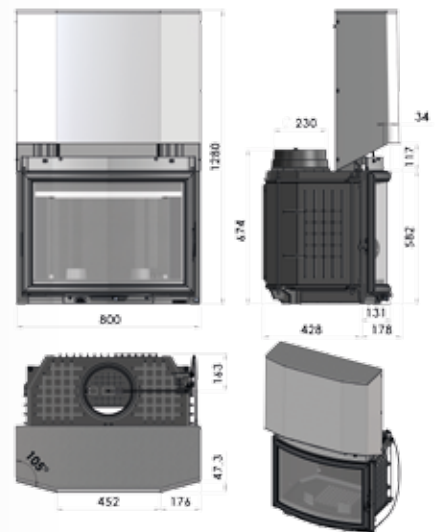

V70V



CS28

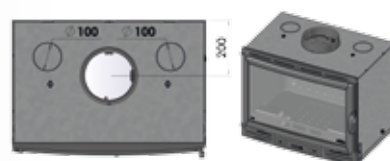
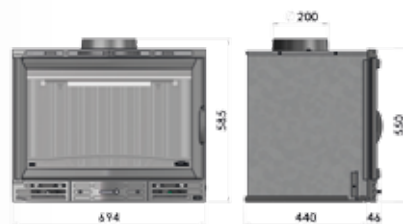

V80V

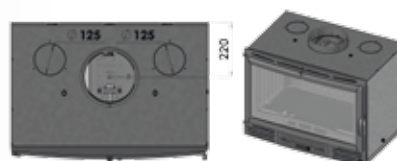
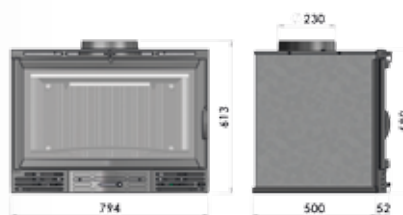

D70V

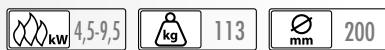

CS41

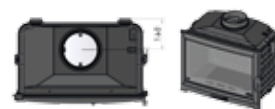
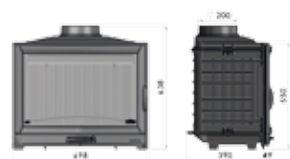

G70V

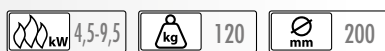

CS15

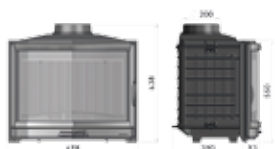

P70V

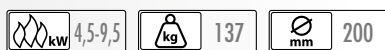

CS23

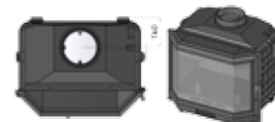
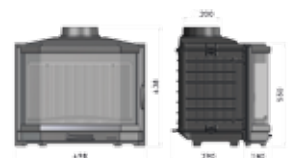

D70DV

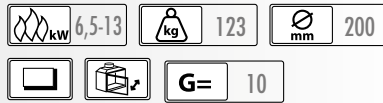

CS45

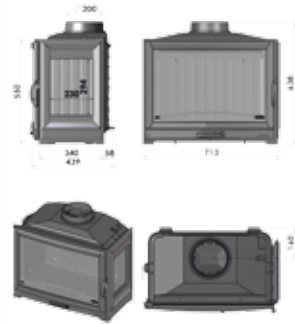

D70GV

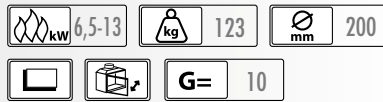

CS46

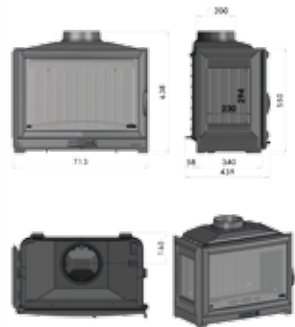

D70D+GV



CS44

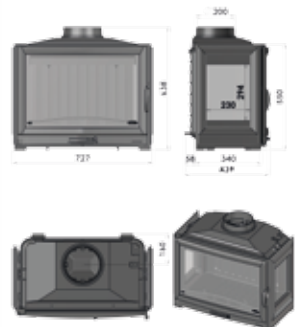

D80V



CS43

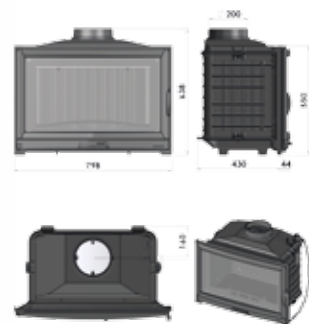

Principe de fonctionnement de l'air de convection et fonctionnement de l'insert fonte

*OPERATING PRINCIPLE OF CONVECTION AIR
FOR CAST IRON INSERT*

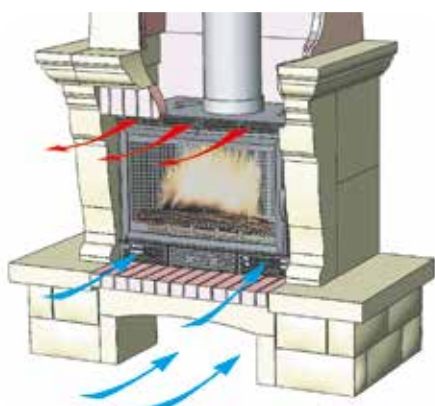

S1 section des entrées d'air de convection : 600 cm² mini

S1: inlet section of convection air: 600 cm² min

S2 section des sorties d'air de convection : 700 cm² mini

S2: outlet section of convection air: 700 cm² mini

S3 section de l'entrée d'air de combustion : 200 cm² mini

S3: inlet section of combustion air: 200 cm² mini

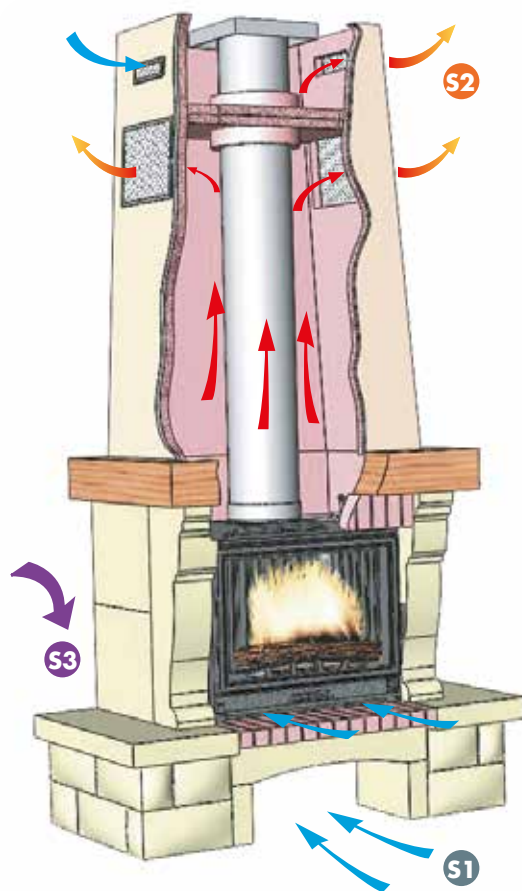

VOLET DE TIRAGE REGLABLE ET DEMONTABLE

Il facilite le ramonage mais surtout entraîne une autonomie remarquable de nos appareils. Un système de réglage par bague situé sur la commande permet un réglage optimal de la combustion.

REMOVABLE AND ADJUSTABLE AIR FLOW CONTROL

This facilitates chimney sweeping and, particularly, provides the remarkable autonomy of our units. A control system provided by a ring located on the control ensures optimal combustion adjustment.

L'AVALOIR PLAT

Élément essentiel de la puissance de votre appareil. Sa conception permet une récupération optimale de l'énergie des fumées avant de les évacuer à grande vitesse (effet Venturi avec le déflecteur). Les poêles à bois utilisent ce même procédé depuis des centaines d'années.

FLAT THROAT

The essential power component of your unit. Its design provides optimal recovery of flue gas before evacuating it at high speed (Venturi effect with baffle). Wood stoves have used this technique for centuries.

LE DÉFLECTEUR GRAND FORMAT PLAT

Couplé avec l'avaloir, il maintient une température élevée sous le déflecteur favorisant une combustion complète du bois.

BAFFLE

with the flat top of the unit, this part maintains a high temperature under this baffle for a complete wood combustion.

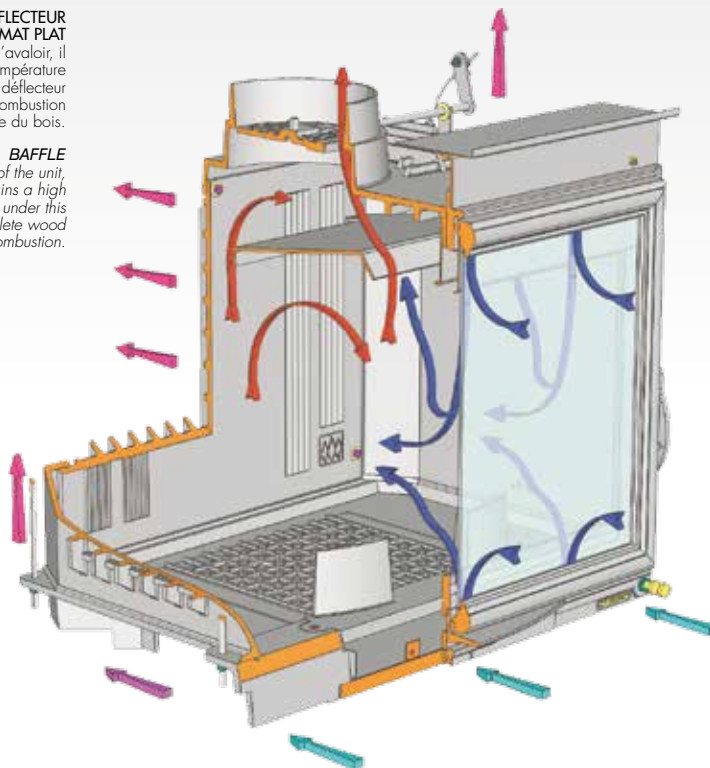

OBTURATEUR DE HOTTE

Ce dispositif évite en cas de mauvaise manipulation ou dans des conditions climatiques extrêmes (tempête, etc...) tout passage de fumée dans la hotte.

SMOKE CHAMBER ORIFICE

In the event of improper handling or severe weather conditions (storm, etc.), this device prevents the passage of smoke into the smoke chamber.

GUIDE D'AIR (selon les modèles)

Il calibre l'entrée d'air secondaire pour maintenir votre vitre propre plus longtemps, mais aussi pour créer un mélange (air-fumée) favorable à une double combustion plus propre protégeant notre environnement écologique.

AIR CONTROL (depending on the models)

This adjusts the secondary air inlet in order to maintain your glass clean as long as possible, as well as creating a mixture of air-smoke which provides environmentally-friendly cleaner combustion.

LE CENDRIER

Équipé d'un coupe cendre il arrase le surplus lors du décentrage évitant ainsi de salir votre intérieur. Quant à sa forme "pelle", elle rend le décentrage très facile même lorsque l'appareil fonctionne.

ASHPIT

Equipped with an ash cut, it piles up the surplus ashes during de-ashing keeping your house clean. Its "shovel" shape facilitates de-ashing even during the use of the unit.

SÉCURITÉ

L'appareil est équipé d'une main froide permettant l'ouverture de la porte et les réglages de l'appareil sans risque. L'obligation d'ouvrir la porte pour décentrer, évite l'effet de forge, phénomène entraînant des températures excessives.

SAFETY

The unit is equipped with a cold handle that allows safe opening of the door and adjustment of the unit. The need to open the door for de-ashing prevents the forge effect that generates excessive temperatures.

Les inserts bois en acier

STEEL WOOD INSERTS



NEW

CLOUD 100R



Dim. : 970 (L) x 545 (P) x 1470 (H) mm
Dim.: 970 (W) x 545 (D) x 1470 (H) mm



NEW

CLOUD 100RDF



Dim. : 900 (L) x 580 (P) x 1470 (H) mm
Dim.: 900 (W) x 580 (D) x 1470 (H) mm



NEW

CLOUD 70RVAG



Dim. : 720 (L) x 485 (P) x 1465 (H) mm
Dim.: 720 (W) x 485 (D) x 1465 (H) mm



NEW

CLOUD 70RVAD



Dim. : 720 (L) x 485 (P) x 1465 (H) mm
Dim.: 720 (W) x 485 (D) x 1465 (H) mm



NEW

CLOUD 70LVAG



Dim. : 690 (L) x 470 (P) x 1225 (H) mm
Dim.: 690 (W) x 470 (D) x 1225 (H) mm

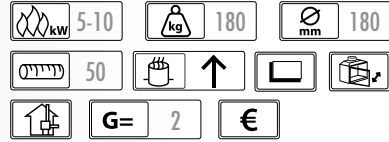

NEW

CLOUD 70LVAD



Dim. : 690 (L) x 470 (P) x 1225 (H) mm
Dim.: 690 (W) x 470 (D) x 1225 (H) mm



VE600



*option métal

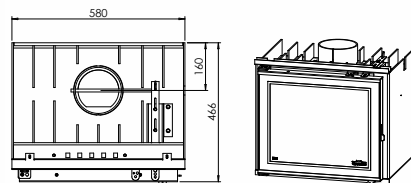
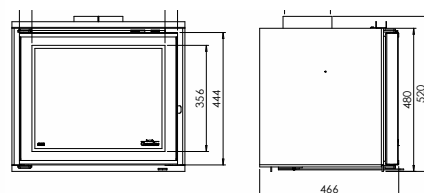

Les intérieurs : 2 possibilités : briques beiges ou option métal*.
 Inserts finishing: 2 choices: beige refractory bricks or option metal*.

VE800

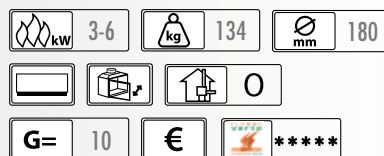

*option métal



Graphite

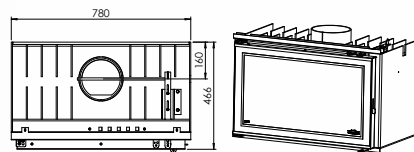
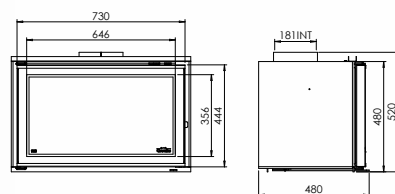

Les intérieurs : 2 possibilités : briques beiges ou option métal*.
 Inserts finishing: 2 choices: beige refractory bricks or option metal*.

VE1000



*option métal



Yoko

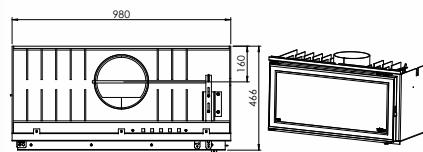
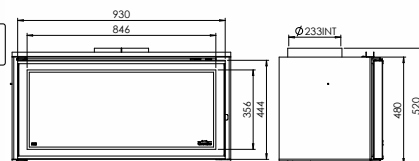

Les intérieurs : 2 possibilités : briques beiges ou option métal*.
 Inserts finishing: 2 choices: beige refractory bricks or option metal*.

VENTUS 60



4,9-9,8
 87
 150

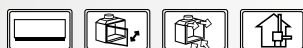

G= 2
 €

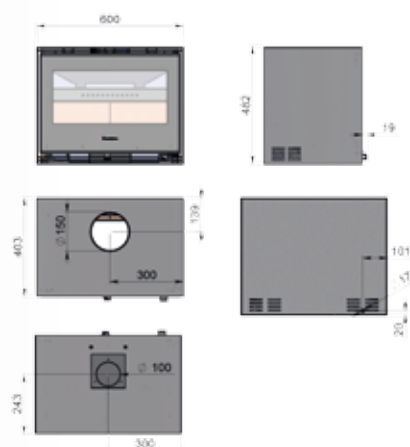

VENTUS 70



5,5-11,5
 97
 150



G= 2
 €

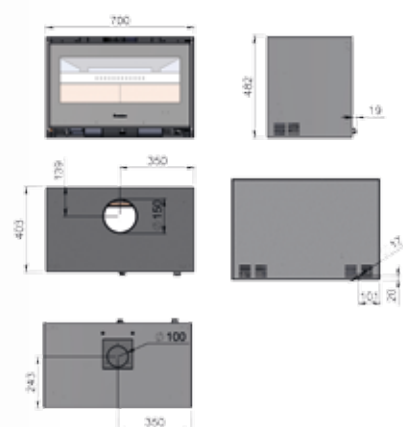

VENTUS 80



6,5-12,5
 107
 180



G= 2
 €

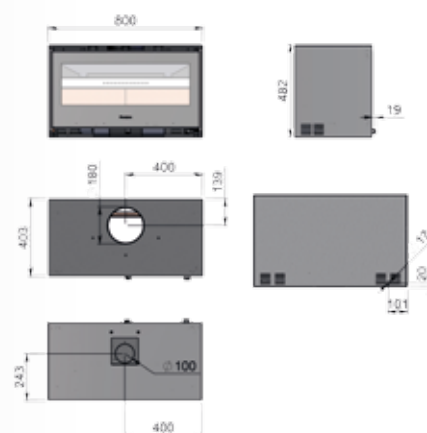

DC840



Jasmin

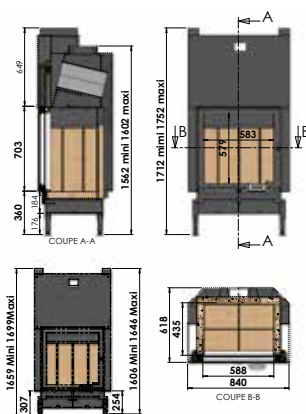

D1000



Pensée

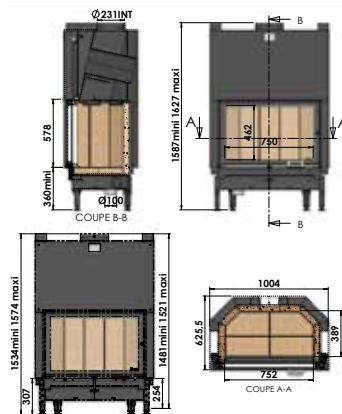

DDF1000

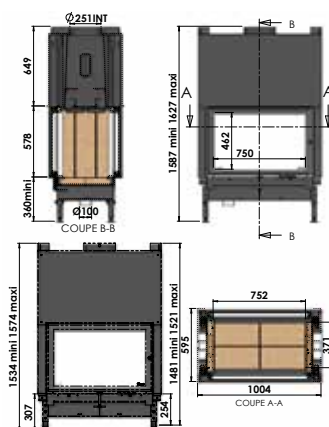

D1000 3V



Baltimore

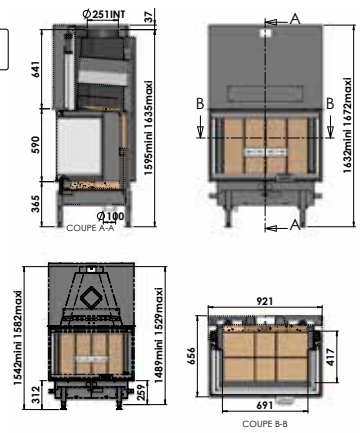

D1000 EPI



Manhattan

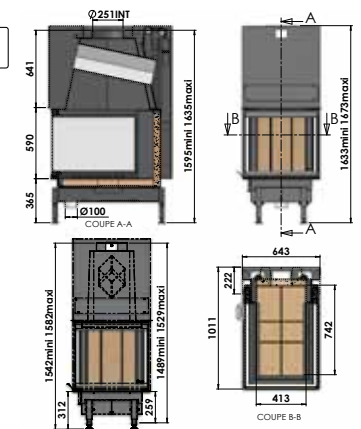

D1000VAD



Atlanta

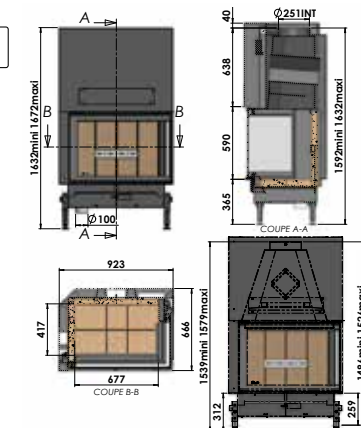

D1000VAG



Ultimate

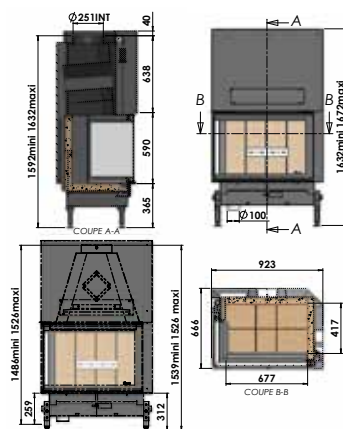

D1200



Galet



D1350



Eden

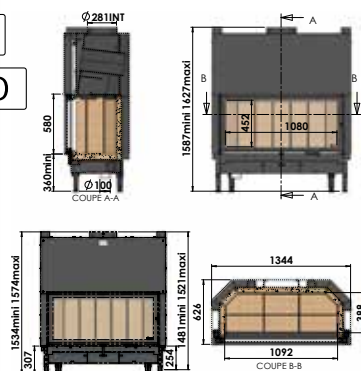

PRINCIPE DE FONCTIONNEMENT : INSERT DESIGN

OPERATING PRINCIPLE: DESIGN INSERT

Système de relevage assuré par glissières acier et roulements haute température. Celui-ci met en pression la porte sur le corps de chauffe seulement en partie basse et permet ainsi d'assouplir le relevage.

Raising system using steel slides and high-temperature bearings. This only puts pressure on the lower part of the fire-chamber door, so enabling more flexible raising.

Air secondaire permanent par la vitre, pour une vitre claire et une post-combustion homogène des fumées. Le démontage d'une plaque permet d'augmenter ce passage d'air.

Permanent secondary air by the window, to ensure clear glass and homogenous post-combustion of smoke. Removal of a plate produces increased airflow.

Commande d'air primaire rotative agissant sur une trappe accessible dans le caisson d'air.

Rotary primary air control acting on an accessible hatch in the air chamber.

Système de pieds soudés sur l'appareil avec 3 positions différentes et réglage de la base des pieds, par l'intérieur de l'appareil, sur 40mm de course.

Feet welded to the appliance with 3 different positions, and adjustment of foot bases, from within the appliance, with 40 mm of movement.

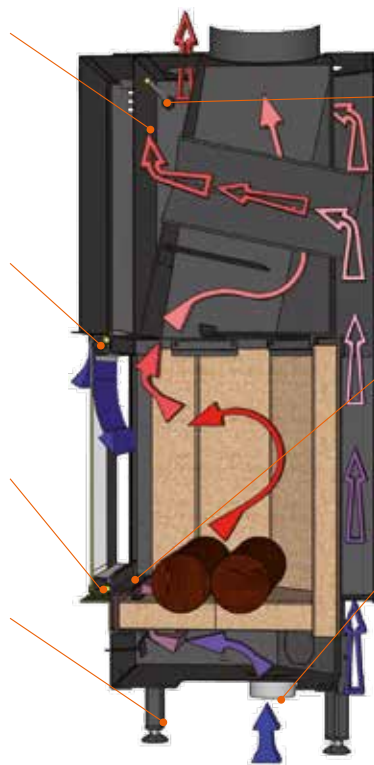

Synchronisation du système de relevage assurée par axe monté sur paliers haute performance, accessibles par caches amovibles.

Synchronisation of raising system ensured by axis mounted on high-performance bearings, accessible by detachable covers.

Système d'admission d'air primaire, surélevé, démontable pour le nettoyage de la chambre de combustion.

Primary air admission system, raised, and easily dismantled for cleaning combustion chamber.

Raccordement possible sur l'extérieur ou sur le côté de l'habillage, par une gaine de Ø100mm connectée sous l'appareil ou sur le côté, à gauche ou à droite. L'air frais est réchauffé dans le caisson d'air avant l'admission dans la chambre de combustion.

Possible connection to the outside or side of the casing, by a Ø100mm duct connected beneath or on the side of the appliance, to the left or right. Cold air is heated in the air chamber before being fed into the combustion chamber.

PRINCIPE DE FONCTIONNEMENT DE L'AIR DE CONVECTION DES INSERTS DESIGN

OPERATING PRINCIPLE OF CONVECTION AIR FOR DESIGN INSERTS

S3
Section de l'entrée d'air de combustion 200 cm² ou Ø 100 mm dans le cas d'un raccordement d'air extérieur

S3: inlet section of combustion air 200 cm² or Ø100 mm in case of connection to outside air

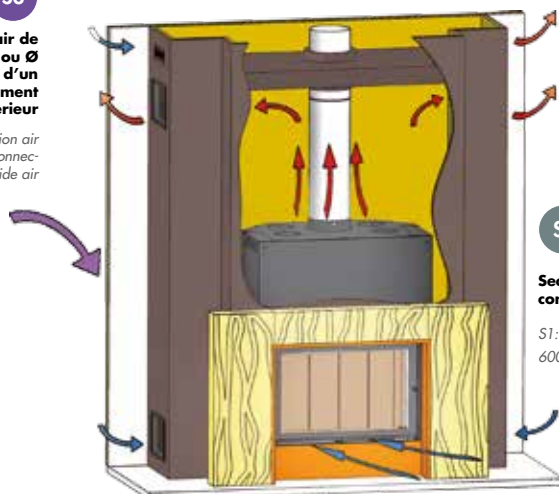

S2

Section des sorties d'air de convection : 700 cm² mini

S2: outlet section of convection air: 700 cm² mini

S1

Section des entrées d'air de convection : 600 cm² mini

S1: inlet section of convection air: 600 cm² mini

MERCURE 90



6,5-12,5	250	200
		0
G= 2	€	*****



Brillac

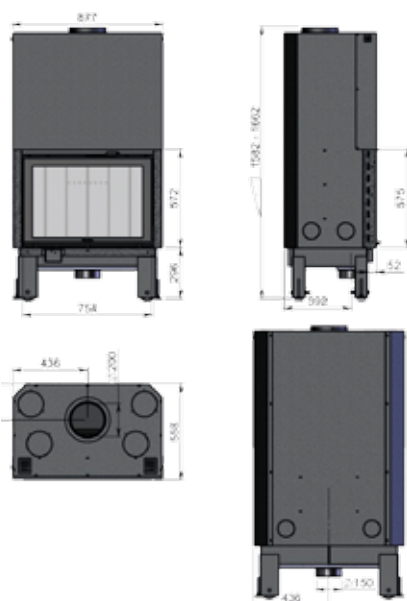

MERCURE 120



7,5-15	260	250
		0
G= 2	€	*****



Vision

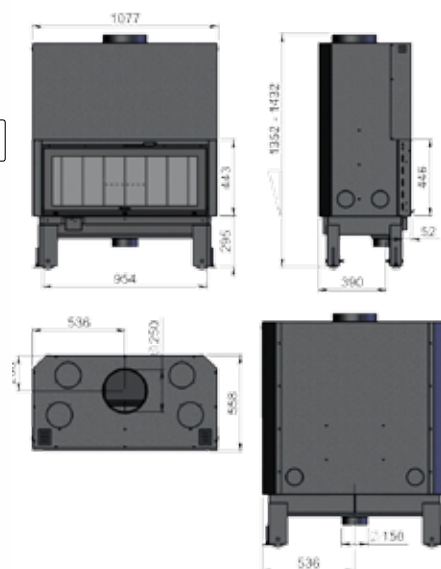

Districhauff : distribution d'air chaud

HOT AIR DISTRIBUTION

POUR PROFITER DU CHAUFFAGE AU BOIS DANS TOUTE LA MAISON.

DISTRICHAUFF: TO ENJOY THE WOOD BURNING IN THE HOUSE



Bois
Wood

DISTRICHAUFF est la solution pour chauffer au bois les pièces de votre maison grâce à votre cheminée et votre insert, et cela sans augmenter votre consommation de bois.

Le système DISTRICHAUFF récupère la chaleur produite par l'insert de votre cheminée pour la distribuer de façon homogène dans plusieurs pièces de la maison, grâce à un réseau composé d'un caisson de distribution de gaines isolées et de bouches de soufflage, assurant la répartition de la chaleur dans les pièces de vie.

With DISTRICHAUFF, you can provide the rooms in your house with wood-fuelled heating from your fireplace and insert without increasing your wood consumption.

The DISTRICHAUFF system retrieves the heat produced by your fireplace insert and distributes it throughout the house via a network made up of a distribution chamber, insulated shafts, and aerators, ensuring that heat is equally distributed to all rooms.

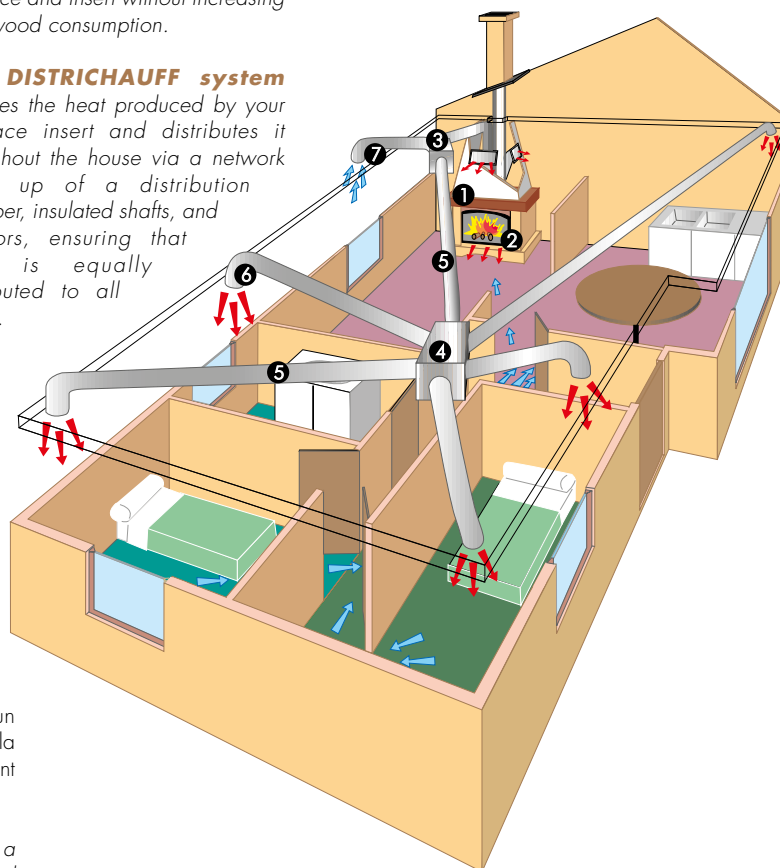

Le système **DISTRICHAUFF** est équipé d'un **BYPASS*** qui limite la mise en dépression de la hotte ou du carénage et améliore considérablement le confort thermique.

*The DISTRICHAUFF system is equipped with a **BYPASS *** who limits the depression of the hood and shroud, and improves thermal comfort.*

> Une distribution d'air chaud ne peut être installée qu'avec un insert Chazelles utilisant le bois comme combustible (compatible avec tous les inserts Chazelles, excepté les inserts double face, vitres à droite ou à gauche, 3 vitres ou EPI, D850 - 180°).

> A hot air distribution must be installed with Chazelles insert using wood as fuel (compatible with all inserts Chazelles, except the double-sided, windows to the right or left, 3 sided or EPI, D850 - 180° inserts).

Le système est composé :
The system is composed:

- 1 : cheminée (habillage du foyer) / fireplace
- 2 : insert / insert
- 3 : groupe de ventilation / airing group
- 4 : caisson de répartition / distribution box
- 5 : Conduit isolé thermique & phonique d'air chaud / insulated ducts in hot air
- 6 : bouches de soufflage / aerators
- 7 : bouche de reprise **BYPASS*** / recycling ducts **BYPASS***

Les inserts hydro

HYDRO INSERTS



CH700C



9,5-19 154 200

G= 2
 50



Oloron

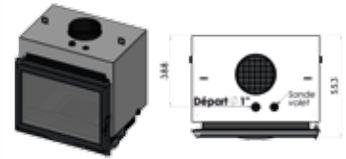
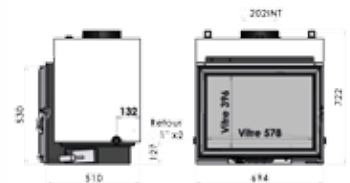

CH860C



13,3-26,7 218 250

G= 2 ****
 50



City

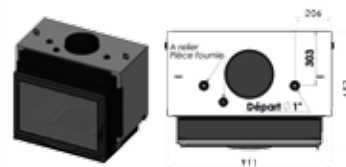
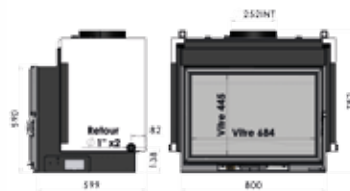

CH1200D



13-26 355 250

G= 2 ****
 50



Vision

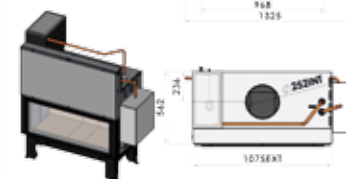
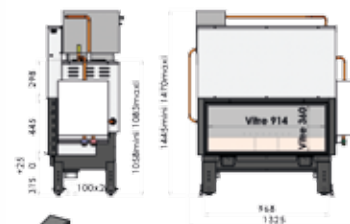

Chazelles Collection Habillages

FIREPLACES LINES

LES CONTEMPORAINES CONTEMPORARY LINE



LES ANTIQUAIRES ANTIC LINE



LES CLASSIQUES CLASSIC LINE



LES RUSTIQUES RUSTIC LINE



LEADER DU SUR-MESURE
DEPUIS PLUS DE 30 ANS
LEADER OF CUSTOM-MADE FOR OVER 30 YEARS

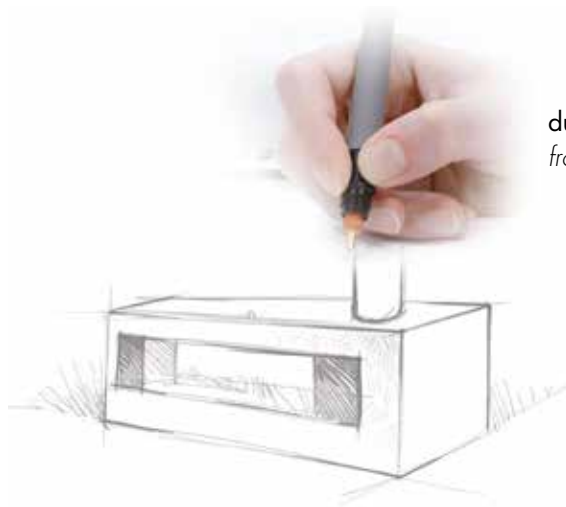

du croquis...
from sketch...

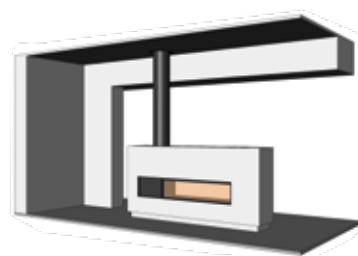

...aux premières images
...to first pictures.

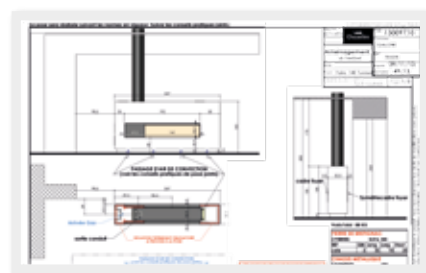

Retrouvez chez tous vos concessionnaires le catalogue Collection Habillages.
For more information, find the Fireplaces Line catalog from your dealers.

Chazelles L'art de vivre côté jardin

THE ART OF GARDEN LIVING



Patrimonio.

Cuisine d'été en pierre de Fontbelle patinée, briquettes de 5 claire flammé pour grill complet Chazelles, avec four à pain grand modèle.

Menuiserie en chêne et plaqué chêne. Plan cuisine en pierre de Bourgogne dorée.

Patrimonio.

Summer kitchen in patined Fontbelle stone, 5 cm clear flame briquettes for full Chazelles grill, with large bread oven.

Oak beams, furniture and shelves. Kitchen plan made of polished gold Burgundy stone.

Spécialiste du feu sous toutes ses formes, Chazelles propose également une collection de barbecues et d'accessoires pour tous types de grillades.

Fire specialist in all its forms, Chazelles also offers a collection of barbecues and accessories for all kind of grills.



Plancha Mania 60

Appareil de cuisson d'extérieur à poser, largeur 60 cm, 2 brûleurs avec sécurité gaz 6000W - allumage électronique. Plancha en fonte émaillée triple couche brillant bâti en inox. Récupérateur de graisse en inox grande capacité. Marquage CE. Alimentation : butane, propane, gaz naturel (en option).

Nombre de convives :
8 à 10 personnes

Plancha Mania 60

Outdoor Cooking Place appliance, width 60 cm, 2 gas burners with safety 6000 W electronic ignition. Enamelled cast iron - griddle triple layer gloss - built in stainless steel. stainless steel grease recuperator, large capacity. Marking CE. Gas: butane, propane, natural gas (optional). Number of guests: 8-10 people

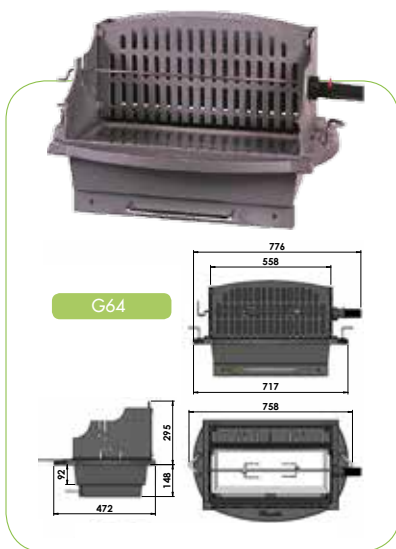
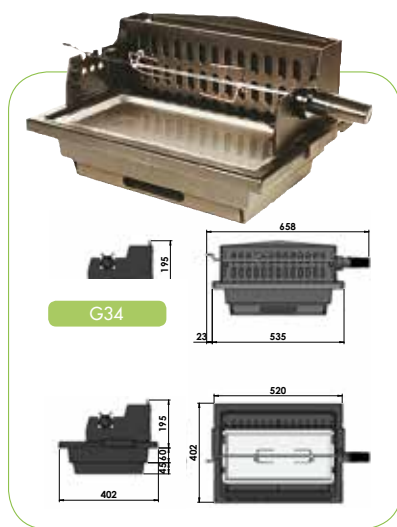
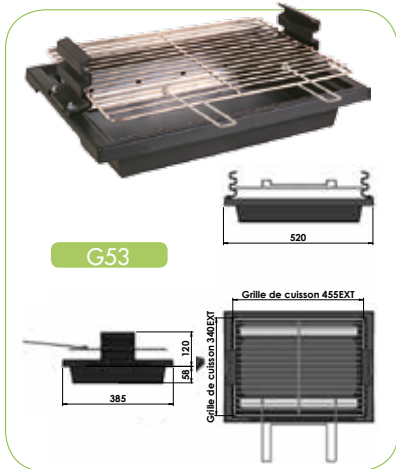

	GRILS BAS Bottom grills	GRILS COMPLETS AVEC ROTISSOIRE Full grills with rotisserie
Petit modèle sans tiroir Small model without drawer	G53 Encastrement 450 x 340 x 50 mm insert dimension = 450 x 340 x 50 mm	
Petit modèle avec tiroir Small model with drawer	G32 Encastrement 450 x 340 x 50 mm insert dimension = 450 x 340 x 50 mm	G34 Encastrement 450 x 340 x 50 mm insert dimension = 450 x 340 x 50 mm
Chazelles Grills avec tiroir Chazelles grills with drawer	G62 Encastrement 560 x 340 x 50 mm insert dimension = 560 x 340 x 50 mm	G64 Encastrement 560 x 340 x 50 mm insert dimension = 560 x 340 x 50 mm
	Garantie 2 ans	Garantie 2 years

> Retrouvez toute la gamme de cuisines d'été, barbecues, grills, rotissoires, planchas dans notre brochure « L'Art de vivre côté jardin », disponible chez votre concessionnaire ou sur notre site internet.

> Find the full range of summer kitchens, barbecues, grills, rotisserie, planchas in our brochure "The Art of Living garden", available from your dealer or on our website.



Autres accessoires disponibles : plats inox, grilles de cuisson, grilles foyères, broches avec moteur, moteurs électriques
Other available accessories: stainless steel cooking sheets, cooking grids, hearth grids, spit with motor, electric motors.

Index poêles & inserts

INDEX STOVES & INSERTS

A ACTUAL	40	D D70D+GV	77	M MEGEVE	45
ADELAIDE	22	D70DV	77	MERCURE	
AGATHA	30	D70GV	77	90	90
ALEYNA	25	D70V	76	120	90
ALIZÉE	31	D80V	77	MODERN	39
ALMA	27	D1000	86	MORZINE	46
AMANDINE	25	D1000 3V	87		
AMBRE	30	D1000 EPI	87	N NEO	40
ANDREA	27	D1000VAD	87	NOMAD	57
ANNA	31	D1000VAG	88		
ARDIDEN	42	D1200	88	O OLZONE	17
ARMELLE	22	D1350	88		
ASSISI	49	DC840	86	P P70V	76
AVORIAZ	43	DDF1000	86	PARIS 8	49
				R RAVENA	49
B BARBARA		E ELANCE	20	RUSTIQUE	41
T-BARBARA C	21	EQUINOXE	38		
T-BARBARA	26			S SINGAPOUR GRANULÉS PELLETS	56
BICE	26	F F70L	69	SINGAPOUR BOIS WOOD	57
BLACKLIGHT	23	FACEL	61	SOLSTICE	38
		500	63	ST MORITZ	46
C C700R VE	72	800	63	STONE	24
C700L	72	800 3V	61		
C800R VE	73	800 VAG & VAD	62		
C800L	73	1000	64	T THORENS	35
CG800L	74	FROG	53	TOWER	24
CG800R	74			V V70V	75
CH700C	93	G G70V	76	V80V	75
CH860C	93	GELA	36	VE600	84
CH1200D	93	GT	18	VE800	84
CHAMONIX	44	H HP530	71	VE1000	84
CP700L	72	HP700	71	VENTUS	
CP700R	73	HP800	71	60	85
CLOUD	81	HYPE L	51	70	85
70LVAD	83	HYPE S	52	80	85
70LVAG	83			VINKLE	54
70RVAD	82	K KYLEN	55		
70RVAG	82	L LIADO	37	Z ZEPHYR	
100R	81			70	66
100RDF	81			80	66
COLIBRI	59				
COMPACT	19				
COURCHEVEL	47				
CUBE 70	56				
CUBO					
60	58				
70	58				
80	59				

La liste des produits ou références, les textes, côtes, images et illustrations, la composition et la couleur des produits, les informations techniques figurant dans ce catalogue n'ont aucune valeur contractuelle. Sous réserve d'erreurs d'impression. Pour plus d'informations contactez votre concessionnaire ou l'usine. Pour améliorer la qualité de ses produits ou pour des raisons techniques, le fabricant peut à tout moment modifier les informations contenues dans ce catalogue. Les photos présentées dans ce catalogue n'ont aucune valeur contractuelle, dans la mesure où l'impression, la qualité du papier, les éclairages de prises de vues peuvent faire varier les couleurs et textures des différents matériaux de nos produits. Edition juin 2014. Création : TOSCARA. Photos : Le Studio Photographique/Studio Langereau/Communication 22/Corbis/Getty Images.

The list of products or references, texts, ratings, images and illustrations, the composition and colour of products, and the technical information appearing in this catalogue have no contractual value. No liability for printing errors. For more information contact your dealer or the plant. To improve the quality of his products or for technical reasons, the manufacturer may amend the information in this catalogue at any time. Published June 2014. Creation: TOSCARA. Photos: Le Studio Photographique/Studio Langereau/Communication 22/Corbis/Getty Images.

Symboles

SYMBOLS



PUISSANCE : MIN - NOMINALE
POWER: MIN - NOMINAL

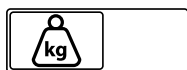

POIDS
WEIGHT



**DIAMÈTRE RACCORDEMENT
SORTIE FUMÉE**
SMOKE EXIT CONNECTION
DIAMETER



LONGUEUR BÛCHE
LOG LENGTH

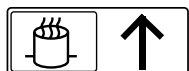

RACCORDEMENT DESSUS
TOP CONNEXION

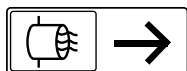

RACCORDEMENT ARRIÈRE
BACK CONNEXION



RACCORDEMENT AIR EXTÉRIEUR
OUTSIDE AIR CONNECTION



AIR VENTILÉ
VENTILATED AIR

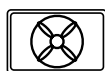

KIT VENTILATION
VENTILATION PACK

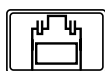

KIT CARÉNAGE
SHROUD KIT

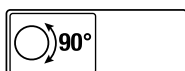

KIT ROTATION
ROTATION KIT



OPTION
OPTIONAL

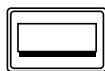

SIMPLE FACE
ONE SIDED



VITRE PRISMATIQUE
PRISMATIC DOOR



VITRE GALBÉE
CURVED DOOR



VITRE 180°
GLASS DOOR 180°

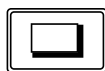

VITRE À DROITE
DOOR FOLDED RIGHT

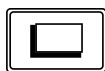

VITRE À GAUCHE
DOOR FOLDED LEFT

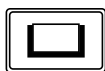

3 VITRES
3 GLASS

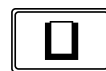

EPI
3 GLASS EPI



INSERT DOUBLE FACE
DOUBLE-SIDED DOOR



INSERT DOUBLE FACE GALBÉ
CURVED DOUBLE-SIDED DOOR



VITRE 360°
GLASS DOOR 360°



CHAUFFAGE PLAISIR
PLEASURE HEATING

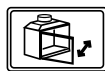

OUVERTURE LATÉRALE
SIDE OPENING

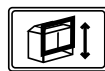

OUVERTURE RELEVABLE
RAISING DOOR



OUVERTURE PAR BASCULEMENT
TOPPLE OVER OPENING



CHAUFFAGE CONFORT
COMFORT HEATING

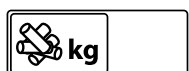

CAPACITÉ RÉSERVOIR PELLETS
PELLET TANK CAPACITY

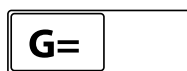

GARANTIE
WARRANTY



CRÉDIT D'IMPÔT
TAX CREDIT



CHAUFFAGE INTENSE
INTENSE HEATING



Bois
Wood



Granulés
Pellets



FLAMME VERTE



Un système d'étiquette classe les appareils en cinq catégories, (sous la forme d'étoiles). Plus la performance globale de l'appareil est importante, plus le nombre d'étoiles affiché sur l'étiquette est élevé, avec un maximum de 5 étoiles.

Pour être labélisés flamme verte, les appareils doivent afficher 4 ou 5 étoiles.

90% de nos appareils sont labélisés 5 étoiles.

Chazelles

Usine : Route de Marthon
16380 Chazelles - FRANCE

www.chazelles.com

CHINVEST SAS au capital de 320 000 euros
R.C.S ANGOULÊME B 408 337 970
SIRET 408 337 970 000 11



www.chazelles.com