





## Pumps and accessories for the air conditioning and refrigeration industry.

Aspen Pumps was established in 1992 by three engineers who were installing air conditioning and refrigeration equipment. This often proved to be awkward with the existing products, so we developed the peristaltic condensate pumps to meet our own needs.

Since then Aspen has developed a market leading range of pumps and accessories that have been designed in the UK, for all conditions and variable installations. Our achievements and success have been built by the hands-on knowledge of installation engineers.



The Queen's Award for Enterprise was awarded to Aspen Pumps. This reflects our success in developing export markets in over 55 countries. The award also recognizes our commitment to innovation, quality of service, and global marketing achievements.



Only Advanced Engineering's indoor range of Coil Cleaners and condensate drain clean are approved 'pump safe' by Aspen Pumps.

- 06 MINI PUMPS**
- 08 Mini & Maxi Orange
- 10 Mini & Maxi Lime
- 12 Lime Systems
- 14 Mini Aqua & Mini Aqua LG
- 16 Mini Blanc
- 18 SILENT+ PUMP RANGE**
- 20 TANK PUMPS**
- 22 Mini Tank Pump
- 24 Hi-flow 0.5L
- 26 Hi-flow 1L & 2L
- 28 Hi-lift
- 30 Heavy Duty
- 32 Hot Water
- 34 PERISTALTIC PUMPS**
- 36 Universal
- 38 Standard
- 40 MK4 & Mechanical
- 42 Compressor Sensor
- 44 SUPERMARKET PUMPS**
- 46 Low Profile ERRP
- 48 ERRP & Cold Cabinet
- 50 Macerator
- 52 BOILER PUMPS**
- 54 PUMP ACCESSORIES**
- 56 RECOVERY UNIT**
- 58 CONTROLS**



# INNOVATIVE PRODUCTS

New pumps to choose from – here are a few!



## Silent+

Installed in a unit or trunking, these pumps run as quietly and efficiently as possible



pg18

## Replacement Packs

The new Mini Orange pack contains two pumps, two reservoirs and two floats



Various Mini Lime packs available with new and improved packaging

pg 8-13

## Mini Tank

An extremely easy to install floor or wall mounted compact pump



pg22

## Boiler

For oil & gas fired condensing boilers and high efficiency gas furnaces

pg52



# MINI PUMPS

Since the launch of the Mini Orange, Aspen has become the global market innovator for Mini Pumps. Aspen has built a reputation for designing reliable and quiet pumps, that the installer can fit where space is limited.

The Mini Lime was an industry revolution, a one piece pump held horizontally within a dedicated system, which allows easy access and pipe management. Following the trend for smaller AC units, the Mini Aqua was designed to fit in the smallest of spaces, continuing Aspen's focus on making the installer's life easier.

QUIET

SMALL

RELIABLE

FLEXIBLE INSTALLATION  
OPTIONS

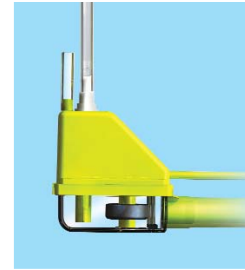

**MINI ORANGE® & MAXI ORANGE®**  
The Mini Orange and Maxi Orange condensate pumps allow great installation flexibility. Perfect for fitting quickly and easily either above the false ceiling, behind wall-mounted evaporators or in the plastic conduit.

**MINI LIME® & MAXI LIME®**  
The Mini and Maxi Lime pumps have unique design and installation advantages. The pumps are clipped directly onto the reservoir so there is minimal suction lift. They are completely reversible and also benefit from easy access for servicing.

**LIME SYSTEMS**  
Select the required Lime pump, then choose the desired system. Five types of trunking systems available. The components required are: pump, elbow, 800mm conduit & ceiling plate. (Pump available without system).

**MINI AQUA®**  
The ultra slim Mini Aqua has been designed to fit in the smallest of spaces, giving the installation flexibility needed where the latest generation of A/C units are becoming even smaller.

**MINI BLANC®**  
The Mini Blanc is the latest addition to our mini pump range, and has a discreet modern appearance. It can be mounted directly below the wall unit very easily.

Mini Pumps accessories are available on page 54

## TECHNICAL SPECIFICATIONS

### Mini Orange

- Pump rating: 230V AC, 16W
- Water flow rate: 14L/hr at zero head
- Max. recommended head: 10m
- 21dB(A) at 1m
- Alternative voltages available
- 1PH 50Hz
- 3A volt-free alarm wires, N.O., N.C., 230V
- Hall effect semi conductor level sensors, with high level safety

### Maxi Orange

- Pump rating: 230V AC, 18W
- Water flow rate: 37L/hr at zero head
- Max. recommended head: 20m
- 35dB(A) at 1m
- Max. water temperature: 40°C
- Discharge tube: 6mm
- Fully potted electronics
- Thermally protected
- CE marked

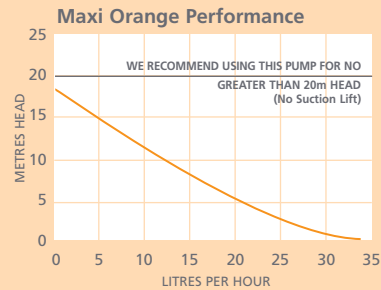
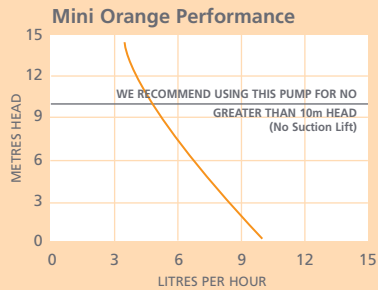

### System Location

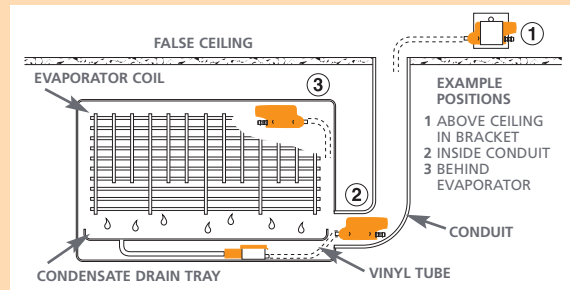

### Pump Dimensions

Product	Height	Width	Depth	Weight
MINI ORANGE	51mm	107mm	39mm	0.25kg
MAXI ORANGE	66mm	122mm	44mm	0.45kg



## ▶ MINI ORANGE® & MAXI ORANGE

The Aspen Mini Orange and Maxi Orange pumps are designed to be installed:

- above the false ceiling where possible
- behind wall mounted evaporators
- in plastic conduit

By connecting the drain hose to the reservoir and placing the pump drive unit within the evaporator, condensate water can be pumped away to a suitable drain.



## TECHNICAL SPECIFICATIONS

### Mini Lime

- Pump rating: 230V AC, 16W
- Water flow rate: 12L/hr at zero head
- Max. recommended head: 10m
- 23dB(A) at 1m
- Alternative voltages available
- 1PH 50Hz
- 3A volt-free alarm wires, N.O., N.C., 230V
- Hall effect semi conductor level sensors, with high level safety

### Maxi Lime

- Pump rating: 230V AC, 18W
- Water flow rate: 35L/hr at zero head
- Max. recommended head: 15m
- 35dB(A) at 1m
- Max. water temperature: 40°C
- Discharge tube: 6mm
- Fully potted electronics
- Thermally protected
- CE marked



MAXI LIME

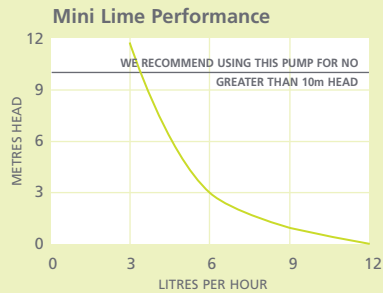

### Pump Dimensions

Product	Height	Width	Depth	Weight
MINI LIME	79mm	99mm	44mm	0.31kg
MAXI LIME	115mm	99mm	44mm	0.47kg



## ▶ MINI LIME® & MAXI LIME

The Aspen Mini & Maxi Lime pumps are completely unique, in both their design and installation advantages. The pumps are clipped directly onto the reservoir so there is minimal suction lift. By connecting the drain hose to the reservoir of the pump unit, condensate water can be pumped away to a suitable drain.

The pumps fit securely into a specifically designed elbow that holds them horizontally to ensure reliable operation. The pump and elbow are reversible therefore they can be installed easily on either side of an evaporator unit.

The Lime system makes installation easy by providing a pump complete with the conduit trunking, in which the pump and all pipework are hidden. This system allows easy access for maintenance and ensures that the reservoir is level at all times.

- **Completely reversible**
- **Quick and easy to install**

### Simple...

1. **Select Mini or Maxi Lime**
2. **Choose from the five trunking ranges available**  
(see next page)

### Systems available for Mini Lime

- Slimline system  
(includes conduit sleeve) IVORY: FP 1500  
WHITE: FP 2857
- BBJ system IVORY: FP 2083  
WHITE: FP 2856
- Inoac/Inaba system IVORY: FP 2100  
WHITE: FP 2855
- Artiplastic system IVORY: FP 2077
- Optimal system WHITE: FP 2291

### Systems available for Maxi Lime

- BBJ system IVORY: FP 2213
- Inoac/Inaba system IVORY: FP 2214
- Artiplastic system IVORY: FP 2405
- Optimal system WHITE: FP 2290

#### Lime Slimline system

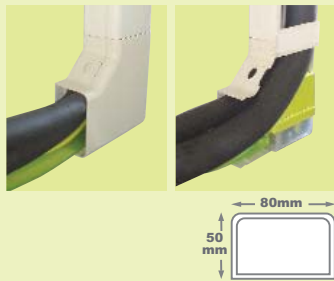

#### Lime Artiplastic system

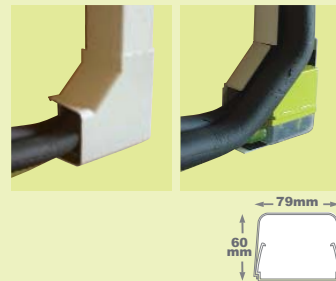

#### Lime BBJ system

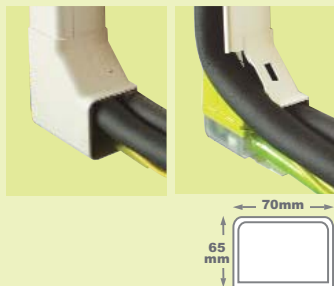

#### Lime Optimal system

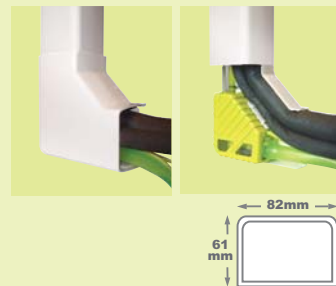

#### Lime Inoac/Inaba system



The Lime pump included in the Optimal system comes complete with a Optimal rubber casing (as shown in the picture above).



SLIMLINE SYSTEM

## ► LIME SYSTEMS

Once you have selected the required pump, the next step is choosing the desired system. There are 5 types of trunking systems available.

**The systems all comprise of all the components required: pump, elbow, 800mm conduit & ceiling plate.**

For simple installations the Slimline system is perfect (Slimline is a non extendable range of trunking).

For both simple and more complex installations the BBJ and Inoac system packs are ideal. They can be integrated within the ranges of BBJ (pages 74/75), Inoac (pages 76/77) and Inaba trunking. This allows for maximum installation flexibility when required.

Finally there are the Artiplastic and Optimal systems which can be integrated within the Artiplastic and Optimal ranges of trunking accessories respectively.

The Lime pumps are also available on their own without trunking (pump only, Qty1):

MINI LIME REPLACEMENT PACK: FP 2124/3 MINI LIME 'EXTRA' REPLACEMENT PACK: FP 2124  
SILENT+ MINI LIME REPLACEMENT PACK: FP 3322 MAXI LIME REPLACEMENT PACK: FP 2215

## TECHNICAL SPECIFICATIONS

- Pump rating: 230V AC, 16W  
Alternative voltages available
- 1PH 50Hz
- 3A volt-free alarm wires, N.O., N.C., 230V
- Hall effect semi conductor level sensors, with high level safety
- Water flow rate: 14L/hr at zero head
- Max. recommended head: 8m
- 21dB(A) at 1m
- Max. water temperature: 40°C
- Discharge tube: 6mm
- Fully potted electronics
- Thermally protected
- CE marked

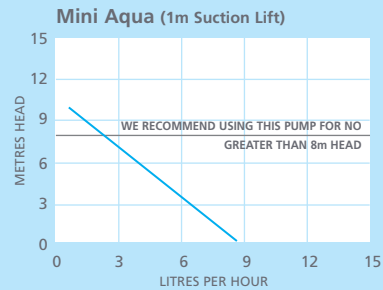
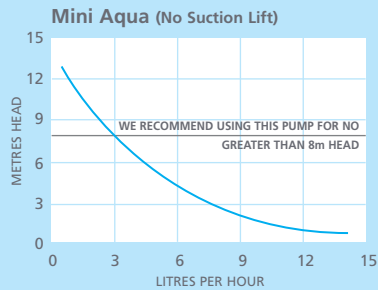

### System Location

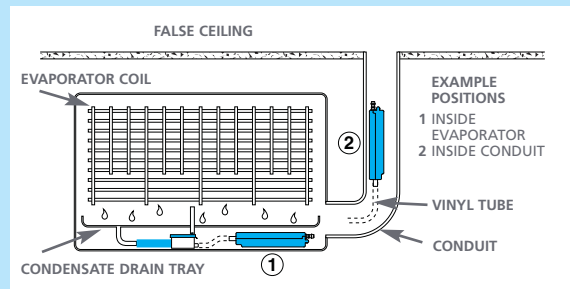

### Pump Dimensions

Product	Height	Width	Depth	Weight
MINI AQUA	28mm	165mm	28mm	0.18kg

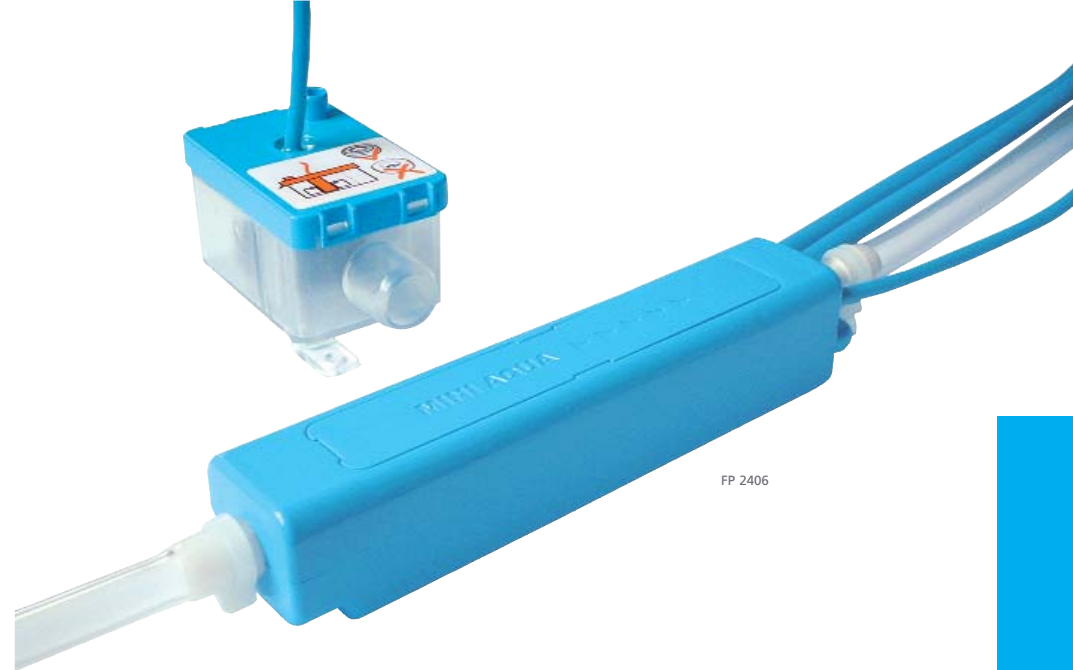

## ▶ MINI AQUA®

It's probably the smallest condensate pump in the world! Designed to fit in the smallest of spaces, giving the installation flexibility needed where the latest generation of A/C units are becoming even smaller. Designed to be installed:

- within wall mounted evaporators
- in plastic conduit

By connecting the drain hose to the reservoir and placing the pump drive unit within the evaporator or conduit, condensate water can be pumped to a height of 8 metres.



ACTUAL SIZE

## MINI AQUA LG

Due to the increasing popularity of the LG Art Cool Gallery, we have designed the Mini Aqua LG. The only condensate pump small enough to fit hidden inside!

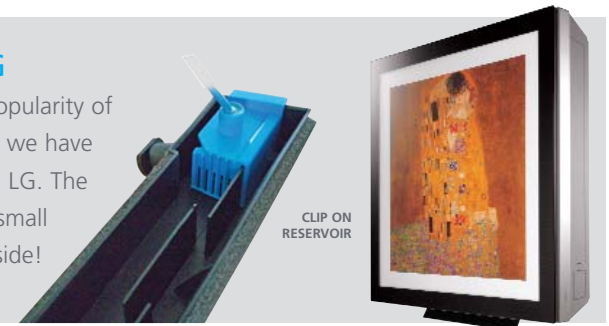

CLIP ON RESERVOIR

FP 1026



## TECHNICAL SPECIFICATIONS

### Mini Blanc – Basic

- Pump rating: 230V AC, 11W
- Water flow rate: 6L/hr at zero head
- Max. recommended head: 4m
- 18dB(A) at 1m
- Hard-wired

### Mini Blanc – Deluxe

- Pump rating: 230V AC, 16W
- Water flow rate: 12L/hr at zero head
- Max. recommended head: 10m
- 21dB(A) at 1m
- Push-in plug

- Alternative voltages available
- 1PH 50Hz
- 3A volt-free alarm wires, N.O., N.C., 230V
- Hall effect semi conductor level sensors, with high level safety
- Max. water temperature: 40°C
- Discharge tube: 6mm
- Inlet size: 21mm  $\varnothing$
- Fully potted electronics
- Thermally protected
- CE marked

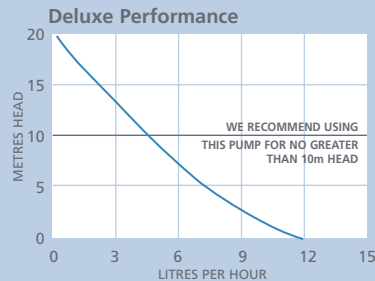
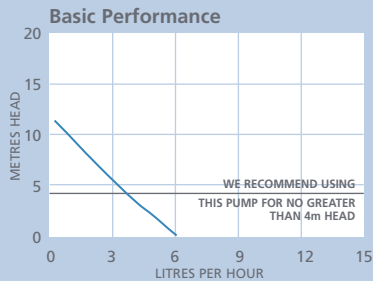

### System Location

Can be placed at any point along bottom edge of the evaporator where the drain hose can exit.

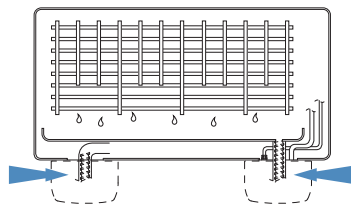

### Pump Dimensions

Product	Height	Width	Depth	Weight
MINI BLANC	115mm	182mm	55mm	0.46kg

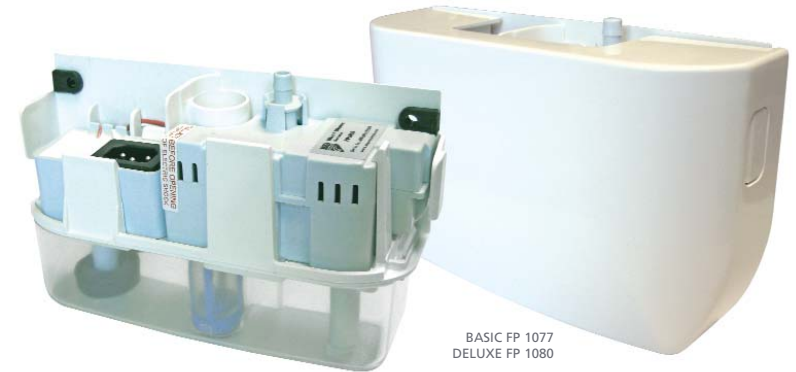

BASIC FP 1077  
DELUXE FP 1080

## ▶ MINI BLANC® BASIC & DELUXE

**Designed to be fitted below the indoor unit, the Mini Blanc offers an extremely easy to install Mini pump for all wall and ceiling suspended indoor units.**

Suitable for both commercial and domestic installations, the quick fit pump is simply screwed to the wall. It is easy to access therefore low maintenance.

The Mini Blanc is ultra quiet in operation as well as discreet with a slim profile of 55mm from the wall.

Available in 2 models, the 'Deluxe' is available with a push-in plug and has a flow rate of 12L/hr and a recommended lift of 10 metres. We also offer the hard-wired 'Basic' with a flow rate of 6L/hr and recommended lift of 4 metres.



**NEW**  
**silent+**  
RANGE

**silent+**  
MINI ORANGE

innovative acoustic damper

The Silent+ Mini Orange is designed with installers in mind and is perfectly suited for offices and meeting rooms.

sound level	max. flow	max. head
19dB(A) at 1m	12L/hr	10m

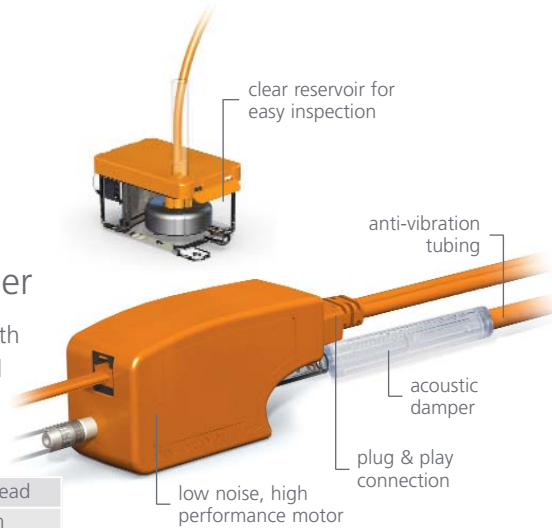

PART NO. FP 3313

**silent+**  
MINI AQUA

ultra-slim design

Very high performance, easy to install, with anti-vibration sleeve.

sound level	max. flow	max. head
19dB(A) at 1m	14L/hr	8m

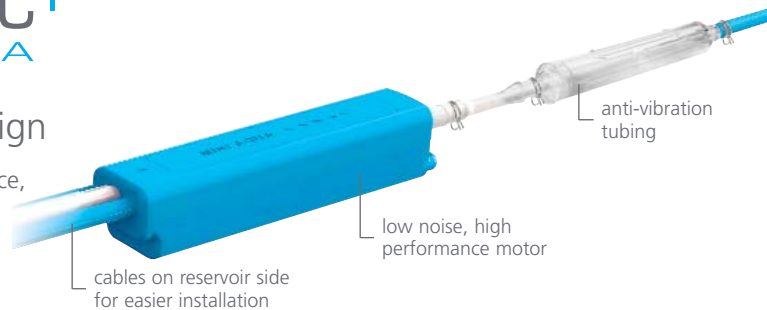

PART NO. FP 3326

**silent+**  
MINI LIME

the quietest in its class

The Silent+ Mini Lime is designed around a 'total system approach' and includes many unique features to create a truly silent system.

sound level	max. flow	max. head
21dB(A) at 1m	12L/hr	10m

PART NO. SLIMLINE IVORY FP 3312, SLIMLINE WHITE FP 3319, ARTIPLASTIC IVORY FP 3315, OPTIMAL WHITE FP3327, BBJ IVORY FP 3316, BBJ WHITE FP 3320, INOAC IVORY FP 3317, INOAC WHITE FP 3321, SILENT+ MINI LIME REPLACEMENT PACK FP 3322

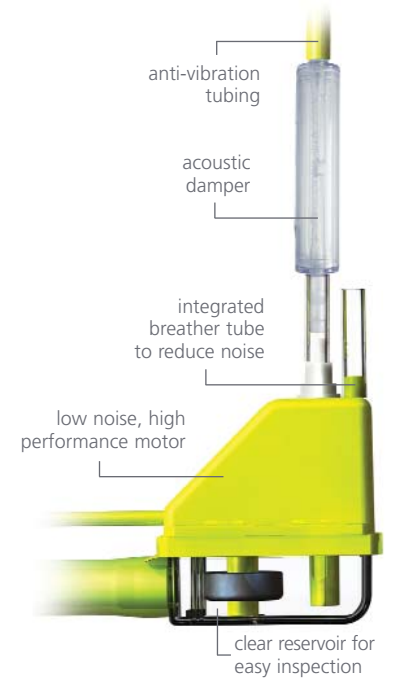

**silent+**  
UNIVERSAL

new motor technology

The highly efficient Silent+ Universal can be placed up to 8m away from the AC unit, making it ideal for the hotel market.

max. flow	max. head
6.25L/hr	12m



PART NO. FP 2593

# TANK PUMPS

When looking for high flow rate, reliability and value for money, Aspen tank pumps are the perfect solution.

Aspen's continued focus on innovation has created a market leading range of tank pumps, designed to suit a diverse array of applications. With reliability as the key decision criteria, the tank pumps are designed to perform even under the most challenging of applications, including hot water.

HIGH FLOW RATES

BUILT IN HIGH LEVEL SAFETY

HOT & COLD WATER OPTIONS

VALUE FOR MONEY



## NEW MINI TANK PUMP

The new compact-design Mini Tank Pump collects condensate water from air conditioning systems with discharge up to a recommended maximum 10 metres head.



## HI-FLOW 0.5L

The Hi-flow 0.5L has the same market leading reliability of the Hi-flow 1L & 2L pumps and is ideal when space is limited.



## HI-FLOW 1L & 2L

Hi-flow tank pumps are designed to collect condensate water from refrigeration and air conditioning units. They operate automatically when the float rises and will discharge to a head of 4.6 metres.



## HI-LIFT 1L & 2L

Hi-lift tank pumps operate automatically when the float rises to discharge to a head of 12 metres. The Hi-lift will pump a smaller volume of water than the Hi-flow, but to a greater head.



## HEAVY DUTY 6M & 10M

Heavy Duty pumps are designed for the rapid removal of condensate. They are particularly useful in situations where multiple refrigeration units are installed.



## HOT WATER HEAVY DUTY/ECONOMY

The Hot Water Heavy Duty and Economy pumps are designed to collect hot water from humidifier drain down cycles and normal condensate water from any associated air conditioning or boiler systems.

Tank pumps accessories are available on page 54

## TECHNICAL SPECIFICATIONS

- Tank capacity: 0.24L
- Discharge head: 10m
- Maximum water pumping capacity: 50L/hr discharge
- High level safety cut-out
- Wall, floor and in pan use
- Maximum water temperature: 40°C
- Inlet seal fits most standard overflow pipe sizes
- Outlet size: 6mm
- Connecting cable: 2m
- Fire retardant plastics
- Maximum noise level: 35dB(A) at 1m
- Pump has a pre-wired safety switch
- Safety switch: 3A maximum
- Pump rating 0.15A, 230V AC, 16W
- CE marked

Mini Tank Pump Performance

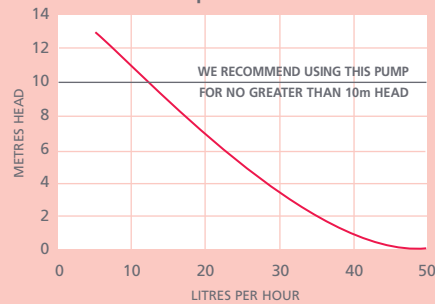

### Service Guide

Flush the pump thoroughly with anti-bacterial wash every 6 months to avoid sludge build-up in the pump housing. Ensure a suitable cleaner is used as plastics can be damaged by certain chemicals.

### Electrical Connections

Brown	Live
Blue	Neutral
2x Black	Safety switch
<input type="checkbox"/> Class II Electrical Appliance	

### Pump Dimensions

Product	Height	Width	Depth	Weight
HI-FLOW 0.5L	70mm	180mm	90mm	0.57kg



## ▶ MINI TANK PUMP

**The new Mini Tank pump is designed to collect condensate water from air conditioning systems and discharge it up to a recommended maximum 10 metres head.**

The internal safety switch is a low current switch to stop the air conditioning system in the event of pump failure. The pump is operated from an internal float switch.

Thanks to its compact design, the Mini Tank pump is extremely easy to install (floor or wall mounted). Its efficiency and top/bottom inlets provide multifunctional use as a stand alone pump, in-pan use or to integrate this pump into an OEM unit (dehumidifiers for example).

## TECHNICAL SPECIFICATIONS

- Tank capacity: 0.5L
- Discharge head: 3.5m
- Water flow rate: 180L/hr max.
- Inline valve to prevent siphoning back
- Pre-wired safety switch 230V, 4.0A max.
- Incorporated back-plate for vertical mounting
- Pump rating: 230V AC, 0.4A  
Alternative voltages available
- Auto-resetting thermal cut-out to shaded pole motor
- Connecting cable: 2m
- Fire retardant plastics
- 3 inlet positions: 2 x 27mm  $\varnothing$ , 1 x 20mm  $\varnothing$  push out
- Outlet size: 6mm & 10mm
- Push-in plug
- CE marked



FP 1194



PUSH-IN PLUG

Hi-flow 0.5L Performance

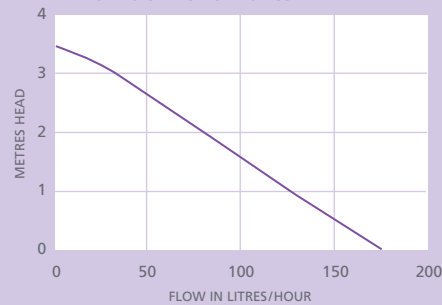

### Service Guide

Flush the pump thoroughly with anti-bacterial wash every 6 months to avoid sludge build-up in the pump housing. Ensure a suitable cleaner is used as plastics can be damaged by certain chemicals.

### Electrical Connections

Brown	Live
Blue	Neutral
Green/ Yellow	Earth
2x Black	Safety switch

### Pump Dimensions

Product	Height	Width	Depth	Weight
HI-FLOW 0.5L	125mm	205mm	120mm	1.4kg

## ► HI-FLOW 0.5L

When you need to remove a lot of condensate water fast, Aspen's range of Hi-flow pumps are the perfect solution.

**The new, stylish Hi-flow 0.5L has the same market leading reliability of the Hi-flow 1L & 2L, and is ideal when space is limited.**

The pump quietly removes up to 180L/hr, with a maximum head of 3.5 metres. For ease of installation there is a push-in plug and an incorporated back-plate for vertical mounting. The installation flexibility continues with three inlet options and a dual-size non-return outlet barb, suitable for both 1/4" and 3/8" tube.

## TECHNICAL SPECIFICATIONS

- Tank capacity: 1L or 2L
- Discharge head: 4.6m
- Water flow rate: 288L/hr max.
- Inline valve to prevent siphoning back
- Pre-wired safety switch 230V, 4.0A max.
- Clear deck for quick and easy inspection
- Incorporated back-plate for vertical mounting
- Pump rating: 230V AC, 0.6A  
Alternative voltages available
- Auto-resetting thermal cut-out to shaded pole motor
- Connecting cable: 2m
- Fire retardant plastics
- 2 inlet positions: 25mm  $\varnothing$
- Outlet size: 6mm & 10mm
- CE marked

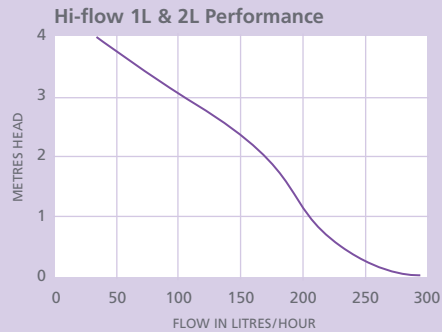

### Service Guide

Flush the pump thoroughly with anti-bacterial wash every 6 months to avoid sludge build-up in the pump housing. Ensure a suitable cleaner is used as plastics can be damaged by certain chemicals.

### Electrical Connections

<b>Brown</b>	Live
<b>Blue</b>	Neutral
<b>Green/ Yellow</b>	Earth
<b>2x Black</b>	Safety switch

### Pump Dimensions

Product	Height	Width	Depth	Weight
<b>HI-FLOW 1L</b>	140mm	235mm	140mm	1.7kg
<b>HI-FLOW 2L</b>	170mm	235mm	140mm	1.75kg



## ► HI-FLOW 1L & 2L

Aspen's Hi-flow tank pumps are designed to collect condensate water from refrigeration and air-conditioning units. They operate automatically when the float rises and will discharge to a head of 4.6 metres.

**The Hi-flow will pump a greater volume of water than the Hi-lift, but to a lesser head.**

The Hi-flows incorporate two high quality switches, activated by a float system. One operates the centrifugal type pump and

the other is used as a high level safety switch. In the event of a pump failure this device will switch off the refrigeration unit and can simultaneously activate an optional audio and/or visual alarm.

The deck of the pump is clear plastic for quick and easy internal inspection, and it comes with a 2 metre long cable with push-in plug which makes installation and maintenance easier.

In all cases a tank pump must be sited under the source of the condensate.

## TECHNICAL SPECIFICATIONS

- Tank capacity: 1L or 2L
- Discharge head: 12m
- Water flow rate: 11L/hr at 12m head
- No siphoning back
- No loud sound from dry running
- Pre-wired safety switch 230V, 4.0A max.
- Requires 230V supply only
- Clear deck for quick and easy inspection
- Fits into shallow ceiling void or unit
- Incorporated back-plate for vertical mounting
- Pumps water, fibrously contaminated water and air
- Pump rating: 230V AC, 0.4A  
Alternative voltages available
- Fire retardant plastics
- 2 inlet positions: 25mm ø
- Outlet size: 6mm
- CE marked

Hi-lift Performance

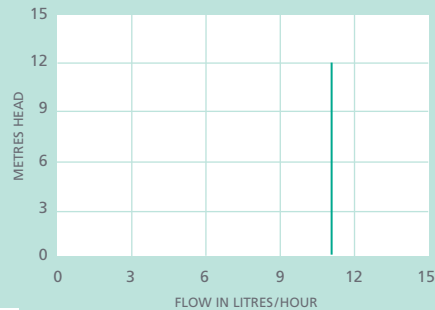

### Service Guide

Inspect the pump head regularly and change the pump head tube every 12 months or more frequently if required. Flush the pump thoroughly with anti-bacterial wash every 6 months to avoid sludge build-up in the pump. This only takes 3 minutes! Ensure a suitable cleaner is used as plastics can be damaged by certain chemicals.

### Electrical Connections

Brown	Live
Blue	Neutral
Green/ Yellow	Earth
2x Black	Safety switch

### Pump Dimensions

Product	Height	Width	Depth	Weight
HI-LIFT 1L	132mm	235mm	140mm	1.8kg
HI-LIFT 2L	165mm	235mm	140mm	2kg



## ▶ HI-LIFT 1L & 2L

Aspen's Hi-lift tank pumps are designed to collect condensate water from refrigeration and air-conditioning units. They operate automatically when the float rises to discharge to a head of 12 metres.

**The Hi-lift will pump a smaller volume of water than the Hi-flow, but to a greater head.**

The pumps incorporate two high quality switches, activated by a float system. One operates the centrifugal type pump and the other is used as a high level safety

switch. In the event of a pump failure this device will switch off the refrigeration unit and can simultaneously activate an optional audio and/or visual alarm.

The pump is a peristaltic rotary type, which means that it is quiet in operation, very reliable and will run dry without fear of damage or embarrassing noise.

Unlike other pumps using either mechanical or electrical conductivity sensors, the Hi-lift does not suffer from corrosion or contamination problems. The deck of the pump is clear plastic for quick and easy internal inspection.

## TECHNICAL SPECIFICATIONS

### Heavy Duty 6m

- Discharge head: 6m
- Pump rating: 230V AC, 1.5A
- Water flow rate: 900L/hr at zero head

### Heavy Duty 10m

- Discharge head: 10m
- Pump rating: 230V AC, 0.49A
- Water flow rate: 1250L/hr at zero head

- Tank capacity: 4L
- Non-return valve
- No siphoning back
- Pre-wired safety switch 230V, 4.0A max.
- Fire retardant plastics
- 2 inlet positions: 40mm ø
- Outlet size: 10mm
- CE marked

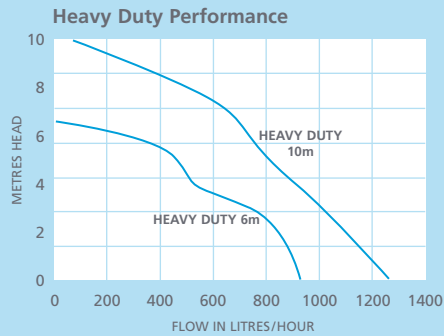

### Service Guide

Flush the pump thoroughly with anti-bacterial wash every 6 months to avoid sludge build-up in the pump housing. Ensure a suitable cleaner is used as plastics can be damaged by certain chemicals.

### Electrical Connections

<b>Brown</b>	Live
<b>Blue</b>	Neutral
<b>Green/ Yellow</b>	Earth
<b>2x Black</b>	Safety switch

### Pump Dimensions

Product	Height	Width	Depth	Weight
HEAVY DUTY 6m	205mm	300mm	150mm	3.5kg
HEAVY DUTY 10m	265mm	300mm	150mm	4.3kg

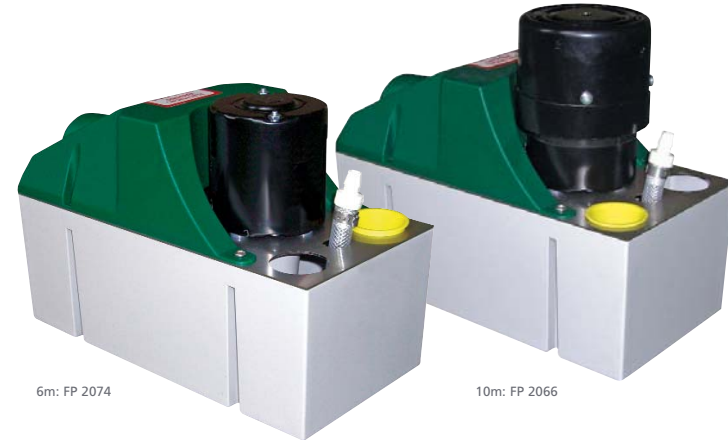

## ▶ HEAVY DUTY 6m & 10m

The Aspen Heavy Duty pumps are designed for the rapid removal of condensate. They are particularly useful in situations where multiple refrigeration units are installed, or where large refrigeration systems deposit considerable quantities of condensate at one time.

The pump unit is robustly constructed and designed to give reliable performance. This is particularly important in environments where efficient cleanliness is of utmost importance.

Two floats provide the operational control, one to operate the pump, and the other a safety float to be wired into the refrigeration unit control circuit.

**The Heavy Duty tank pumps have a greater water flow rate than the Hi-flow tank pumps, for more heavy duty applications.**



## TECHNICAL SPECIFICATIONS

### Hot Water Heavy Duty

- Tank capacity: 5L
- Discharge head: 15m
- Water flow rate: 1800L/hr at zero head
- Pre-wired safety switch 230V, 4.0A max.
- Pump rating: 230V AC, 1.1A
- Max. water temperature: 100°C
- Connecting cable: 2m
- 2 x non-return check valves
- 2 inlet positions: 40mm ø
- Outlet size: 15mm
- CE marked

### Hot Water Economy

- Tank capacity: 4L
- Discharge head: 6m
- Water flow rate: 900L/hr at zero head
- Pre-wired safety switch 230V, 4.0A max.
- Pump rating: 230V AC, 1.5A
- Max. water temperature: 100°C
- Connecting cable: 2m
- Fire retardant plastics
- No non-return valve supplied
- 2 inlet positions: 40mm ø
- Outlet size: 10mm
- CE marked

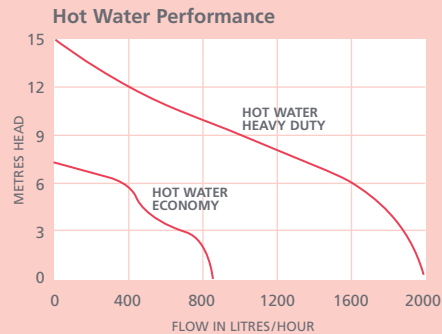

### Service Guide

Flush the pump thoroughly with anti-bacterial wash every 6 months to avoid sludge build-up in the pump housing. Ensure a suitable cleaner is used as plastics can be damaged by certain chemicals.

### Electrical Connections

Brown	Live
Blue	Neutral
Green/ Yellow	Earth
2x Black	Safety switch

### Pump Dimensions

Product	Height	Width	Depth	Weight
HOT WATER HEAVY DUTY	160mm	355mm	320mm	7kg
HOT WATER ECONOMY	205mm	300mm	150mm	3.6kg

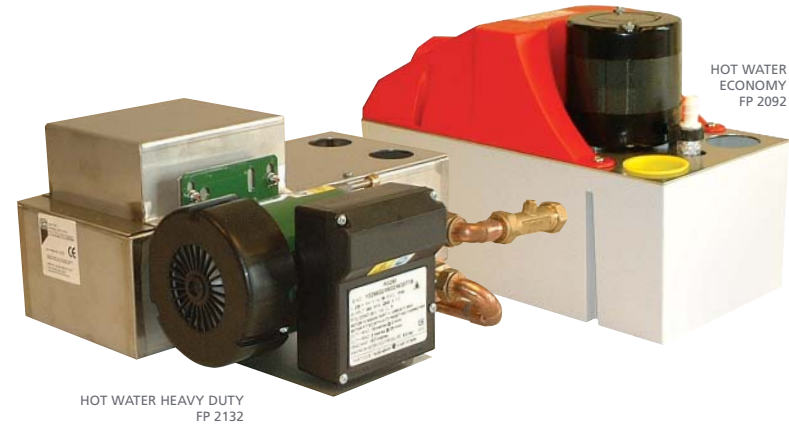

## ▶ HOT WATER HEAVY DUTY & ECONOMY

The Hot Water pumps are designed to collect hot water from humidifier drain down cycles and normal condensate water from any associated air conditioning or boiler systems.

### Hot Water Heavy Duty

The internal pre-wired safety float is a low current switch to stop the drain down cycle in the unlikely event of pump failure. The pump is operated via internal float switches.

### Hot Water Economy

The pump unit is built of heat resistant cycloloy and operates in the same way as the Heavy Duty tank pumps (see pages 30-31).

# PERISTALTIC PUMPS

In 1992 Aspen pioneered the use of peristaltic condensate pumps and today are still setting the standard for reliability and innovation.

Peristaltic pumps offer the ideal solution for condensate removal due to the combination of quietness, reliability and installation advantages. The peristaltic rotary movement generates a continuous pressure meaning that the pump can be sited over 15 metres away from the condensate source with no effect on performance. In addition, the pump mechanism does not come into contact with the water, removing the risk of contamination or corrosion.

QUIET OPERATION

SITED AWAY FROM THE  
CONDENSATE SOURCE

RELIABILITY & LONG LIFE

CAN RUN DRY

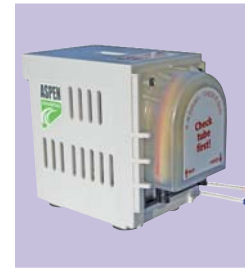

## UNIVERSAL

The Universal peristaltic pump operates with two temperature sensors. These allow the pump to detect and be triggered by a change in air temperature, making this pump suitable for many applications.



## STANDARD

The Standard peristaltic pump is triggered by the hard-wired cooling signal from the air conditioning unit.



## MK4

The MK4 peristaltic pump operates using water level sensors. This allows the pump to detect and be triggered by the level of water in the condensate tray.



## MECHANICAL

The Mechanical peristaltic pump operates by using a remote reservoir with an internal float mechanism. It is available with or without a high level sensor output.



## COMPRESSOR SENSOR

Ideal for applications where complete silence is important. The Compressor Sensor pump is triggered by a sensor, which is designed to be mounted onto the compressor in an external condenser unit.

Peristaltic accessories are available on page 54

## TECHNICAL SPECIFICATIONS

- Senses 5°C differential across the evaporating coil
- Only requires live/neutral supply and 2 sensors either side of the evaporating coil – one 'air on' and one 'air off'
- Operates only on cooling
- Self-priming lifts 3m
- Discharge head: 12m
- Water flow rate: 6.25L/hr at 12m head
- 3 minute timer overrun
- No siphoning back
- No loud sound from dry running
- Manual test switch
- Pumps water, fibrously contaminated water and air
- Pump rating: 230V AC, 0.2A  
Alternative voltages available
- Connecting cable: 3m
- Fire retardant plastics
- Inlet/outlet size: 6mm
- Push-in plug
- Wall-mounted bracket
- CE marked

### Installation Notes

Connect the pump to the appropriate drip tray (using the vinyl tube supplied), then connect to the mains power supply. Situate the **red sensor** in the ambient 'air on' side of the evaporating coil (NOT TOUCHING COIL). Position the **blue sensor** to the 'air off' side of the evaporating coil. **This will sense 5°C differential and operate the pump.**

The pump is designed to sit level on its base and **MUST** at all times have adequate space around it for good ventilation.

Ensure that there are no kinks or trapped parts in the piping, which must have a 6mm I/D and a 9mm O/D. Fix the pipes with cable ties to the pump inlet and outlet.

**PLEASE NOTE: where space is limited lay and fix suction vinyl tube along bottom of condense tray, as pump is self-priming.**

A variable connector is provided to make easy installation between the condensate tray outlet and vinyl tube.



PUSH-IN PLUG

### Service Guide

We recommend that you inspect the pump head regularly, and change the pump head tube every 12 months or more frequently if required.

### Electrical Connections

Brown	Live
Blue	Neutral
Green/ Yellow	Earth

### Pump Dimensions

Product	Height	Width	Depth	Weight
UNIVERSAL	115mm	135mm	77mm	1.35kg



FP 2082/2

## ► UNIVERSAL

**The Universal peristaltic pump operates with two temperature sensors. These allow the pump to detect and be triggered by a change in air temperature, making this pump suitable for many applications.**

The Universal is designed to fit in ceiling voids and lift the condensate water from wall mounted machines where a gravity drain is too obtrusive. It can also be used on cassettes fitted with an internal lift pump.

The pump can be mounted remotely as it is self-priming to a height of

3 metres and will pump 6.25 litres of water per hour against a maximum head of 12 metres. The pump runs constantly while the air conditioning system is cooling – when the cooling switches off a 3 minute timer ensures that the condensate tray is emptied before the pump switches off.

The Universal pump is a peristaltic rotary type – which means that it is quiet in operation, very reliable and will run dry without fear of damage or embarrassing noise. Unlike other pumps using either mechanical or electrical conductivity sensors, the Universal does not suffer from corrosion or contamination problems.

## TECHNICAL SPECIFICATIONS

- Operates on hard-wired 150-230V cooling signal
- Self-priming lifts 3m
- Discharge head: 12m
- Water flow rate: 6.25L/hr at 12m head
- 3 minute timer overrun
- No siphoning back
- No loud sound from dry running
- Manual test switch
- Pumps water, fibrously contaminated water and air
- Pump rating: 230V AC, 0.2A  
Alternative voltages available
- Connecting cable: 2m
- Fire retardant plastics
- Inlet/outlet size: 6mm
- Push-in plug
- Wall-mounted bracket
- CE marked

### Installation Notes

Connect the pump to the appropriate drip tray (using the vinyl tube supplied), then connect to the mains power supply, and control link to the air-conditioning units cooling signal.

**PLEASE NOTE:** The signal wire must be connected to the cooling signal only. This ensures that when the system is on heating, the pump does not run.

The pump is designed to sit level on its base and **MUST** at all times have adequate space around it for good ventilation.

Ensure that there are no kinks or trapped parts in the piping, which must have a 6mm I/D and 9mm O/D. Fix the pipes with cable ties to the pump inlet and outlet.

A variable connector is provided to make easy installation between the condensate tray outlet and vinyl tube.

All peristaltics come with a wall-mounted bracket, is designed to hold a replacement head tube for servicing convenience.



### Service Guide

We recommend that you inspect the pump head regularly, and change the pump head tube every 12 months or more frequently if required.

### Electrical Connections

<b>Brown</b>	Live
<b>Blue</b>	Neutral
<b>Green/ Yellow</b>	Earth
<b>Black</b>	Switched live from signal

### Pump Dimensions

Product	Height	Width	Depth	Weight
<b>STANDARD</b>	115mm	135mm	77mm	1.35kg



## ▶ STANDARD

**The Standard peristaltic pump is triggered by the hard-wired cooling signal from the air conditioning unit.**

The Standard is designed to fit in ceiling voids and lift the condensate water from wall mounted machines where a gravity drain is too obtrusive. It can also be used on cassettes fitted with an internal lift pump.

The pump can be mounted remotely as it is self-priming to a height of 3 metres and will pump 6.25 litres of water per hour against a maximum head of 12 metres.

The pump runs constantly while the air conditioning system is cooling – when the cooling switches off a 3 minute timer ensures that the condensate tray is emptied before the pump switches off. Rollers in the pump act as check valves to stop the condensate draining back into the condensate tray.

The Standard pump is a peristaltic rotary type – which means that it is quiet in operation, very reliable and will run dry without fear of damage or embarrassing noise. Unlike other pumps using either mechanical or electrical conductivity sensors, the Standard does not suffer from corrosion or contamination problems.

## TECHNICAL SPECIFICATIONS

### MK4

- Operates on bead contact with water
- 3 minute timer overrun

### Mechanical

- Operates on a float switch
- 2 reservoir options available
- Available with high level sensor option
- Float switch cable: 3m

- Self-priming lifts 3m
- Discharge head: 12m
- Water flow rate: 6.25L/hr at 12m head

- No siphoning back
- No loud sound from dry running
- Manual test switch
- Pumps water, contaminated water and air
- Pump rating: 230V AC, 0.2A  
Alternative voltages available
- Connecting cable: 2m
- Fire retardant plastics
- Inlet/outlet size: 6mm
- Push-in plug
- Wall-mounted bracket
- CE marked

### MK4 Installation Notes

Connect the pump to the appropriate drip tray (using the vinyl tube supplied), then connect to the mains power supply.

#### WATER LEVEL DETECTOR:

When the unit is first switched on you need to allow 5 mins for the electronics to stabilise.

To ensure that the detector will operate satisfactorily, please abide by the following:

1. The detector will trigger when the water level has reached the first 2 or 3mm of the sensor, this should be taken into account when positioning the height of the sensor. As the device works on heat conductivity it can take up to 30 secs for the pump to switch on.
2. Position the sensor away from direct draught and make sure the tip is a minimum of 5mm from the base of the tray. Ensure the tip is in free air and unable to touch the sides. The ambient sensor within the cable 5cm from the tip can be seen as a small disc beneath the sleeve, this should also be positioned in free air to avoid any heat conduction.

### Mechanical Installation Notes

Connect to the mains power supply.

Decide which reservoir is correct for your installation and position the reservoir into the condensate tray or to the drainpipe connection (depending on which reservoir you use).

Ensure you have placed the float magnet facing upwards. Then Connect the pump to the reservoir (using the vinyl tube supplied).

**ALWAYS ENSURE RESERVOIR IS MOUNTED HORIZONTALLY**

The pump is designed to sit level on its base and must at all times have adequate space around it for good ventilation.

Ensure that there are no kinks or trapped parts in the piping, which must have a 6mm I/D and an 9mm O/D. Fix the pipes with cable ties to the pump inlet and outlet.

Both the MK4 and Mechanical share the same **SERVICE GUIDE & ELECTRICAL CONNECTIONS** as the Universal peristaltic pump (see page 36).

### Pump Dimensions

Product	Height	Width	Depth	Weight
MK4 & MECHANICAL	145mm	160mm	83mm	1.7kg



FP 2080

FP 2078  
(WITH HIGH LEVEL SAFETY SWITCH): FP 2079

## ▶ MK4, MECHANICAL & MECHANICAL ALARM

The MK4 peristaltic pump operates using water level sensors. This allows the pump to detect and be triggered by the level of water in the condensate tray.

The detector has two sensors within the head which warm up to 15°C above ambient. When the lower sensor comes into contact with water, the heat conductivity from the sensor provides a temperature difference energising the pump. Once the level of the water has dropped below the tip of the sensor, the pump will continue until the sensor has completely dried out.

The Mechanical peristaltic pump operates by using a remote reservoir with an internal float mechanism. It is available with or without a high level alarm output.

The pump is designed to be mounted remotely if required and has a 3 metre (9.8ft) lead to the float switch. Simply position the float switch in the condensate tray or fix to the drain-pipe connection (depending on chosen reservoir). Then connect the reservoir to the pump. Mechanical Peristaltic is also available with Alarm Safety Switch.

## TECHNICAL SPECIFICATIONS

- Operates on E.M. field compressor signal
- Self-priming lifts 3m
- Discharge head: 12m
- Water flow rate: 6.25L/hr at 12m head
- 3 minute timer overrun
- No siphoning back
- No loud sound from dry running
- Manual test switch
- Pumps water, fibrously contaminated water and air
- Pump rating: 230V AC, 0.2A  
Alternative voltages available
- Connecting cable: 3m
- Sensor cable: 10m
- Fire retardant plastics
- Inlet/outlet size: 6mm
- Push-in plug
- Wall-mounted bracket
- CE marked

### Installation Notes

Decide where the pump will be located and connect it to the appropriate drip tray (using 6mm I/D vinyl tube), then connect to a 240V mains power supply.

Position the sensor vertically against the compressor, so it protrudes above the top of the compressor like an aerial. This is important as it is where the electromagnetic field is strongest. Use the cable tie supplied to fix the sensor securely to the compressor. A 10m sensor cable is supplied, which can be extended if required.

The pump is designed to fit level on its base and **MUST** have adequate ventilation space around it at all times.

Ensure that there are no kinks or trapped sections in the piping, which must have a 6mm I/D and 9mm O/D. Fix the pipes with cable ties to the pump inlet & outlet.

A variable connector is provided to allow easy fixing between the condensate outlet tray and the vinyl tube.

### Service Guide

We recommend that you inspect the pump head regularly, and change the pump head tube every 12 months or more frequently if required.

### Electrical Connections

<b>Brown</b>	Live
<b>Blue</b>	Neutral
<b>Green/ Yellow</b>	Earth

### Pump Dimensions

Product	Height	Width	Depth	Weight
<b>PUMP</b>	145mm	160mm	83mm	1.7kg
<b>SENSOR</b>	126mm	22mm	16mm	0.1kg



## ► COMPRESSOR SENSOR

**Ideal for applications where complete silence is important.**

The Compressor Sensor pump is triggered by a sensor, which is designed to be mounted onto the compressor in an external condenser unit. When the air conditioning system starts up, the compressor produces a localised electromagnetic field, triggering the sensor, which in turn activates the peristaltic pump. The pump runs constantly while the compressor is operational. When the compressor switches off, a 3 minute timer ensures that the condensate tray is emptied before the pump switches off.

Rollers in the pump act as check valves to stop the condensate draining back into the condensate tray.

The pump can either be fitted in the ceiling void or installed within the condenser unit (or nearby), as long as the pump and its plug/socket are sheltered and fully protected from any water ingress. The pump can be mounted remotely in this way, as it is self-priming to a height of 3 metres and will pump 6.25L/hr of water against a maximum head of 12 metres. The Compressor Sensor pump is a peristaltic rotary type – which means that it is quiet in operation, very reliable and will run dry without fear of damage or embarrassing noise.

# SUPERMARKET PUMPS

**A complete solution, to meet the growing demand for the reliable condensate removal pumps within the retail refrigeration industry.**

As environmental concerns grow over the use of energy within the retail sector, the use of energy inefficient evaporator/condensate trays is starting to raise questions. Aspen's refrigeration pumps offer a lower carbon alternative. The range is designed to work with integral HT or LT multidecks. The pumps are suitable for use by both the OEM market and direct installers.

QUICK AND EASY TO INSTALL

EXCEPTIONALLY RELIABLE

EASY TO CLEAN

LOWER CARBON  
ALTERNATIVE TO  
EVAPORATOR TRAYS

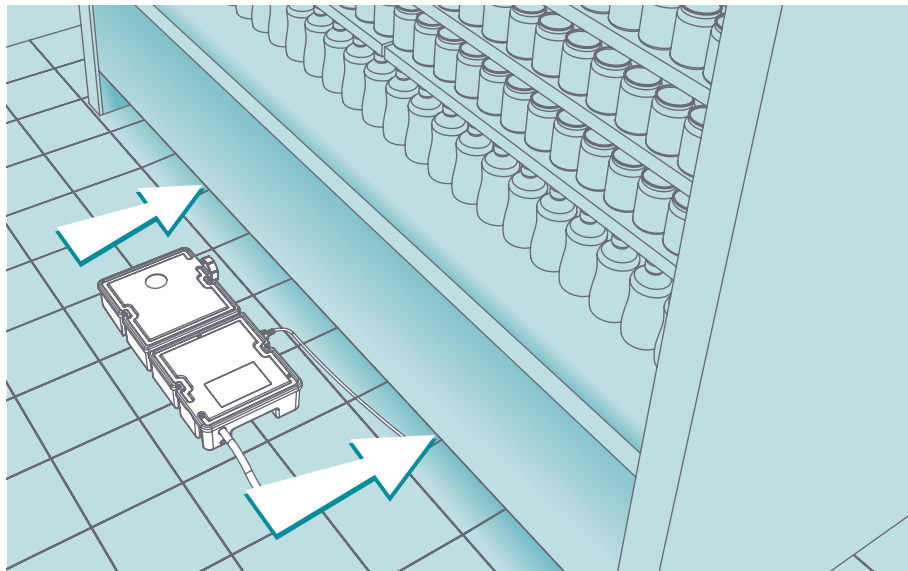

## LOW PROFILE ERRP

Standing at a height of only 75mm, it is a simple but very effective solution for the removal of water from directly underneath refrigeration units during the auto defrost cycle. Ideal for individual refrigeration units with limited space, it is suitable for both the OEM market and for direct installers.



## ERRP

The high capacity Economy Retail Refrigeration Pump tank and covers are plastic, which not only makes the unit lightweight and easy to clean, but has allowed the freedom to incorporate extra features to benefit the service engineer during installation and maintenance.



## COLD CABINET

The stainless steel Cold Cabinet Refrigeration Pumps high capacity permits the draining of several units together. The pump is operated by floats which activate sensors as the water level rises in the tank. Cleaning and maintenance of the pump is simple, as they can be removed easily from underneath any unit.



## MACERATORS

The Macerator pumps are designed to collect condensation and defrost water from food hall cabinets. They both feature an internal filter blade to stop the pump from clogging with food debris between maintenance visits and will discharge the water to a head of 8.5 metres.

Pump accessories are available on page 54

## TECHNICAL SPECIFICATIONS

- Tank capacity: 3.5L
- Water flow rate: 190L/hr max.
- Max. recommended head: 21m
- Pump rating: 230V AC, 1.6A
- Thermally protected
- High level safety switch
- Filter to catch debris
- Outlet size: 10mm
- Inlet hole to lid: 50mm
- Side inlet option available
- Plastic tank/cover
- Lightweight
- Push-in plug
- Handles to enable easy carrying
- Water temperature: 0°C to 40°C
- Single float hall effect switch

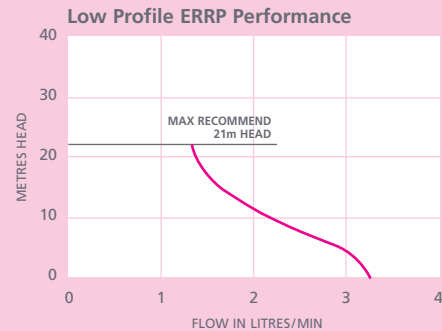

### Service Guide

**IMPORTANT:** Flush the pump through with anti-bacterial wash and clean both filters every 6 months or more often if required, to avoid sludge build-up. Replacement anti-bacterial "Stayclean" strips are recommended and are available from Aspen Pumps.

### Electrical Connections

Brown	Live
Blue	Neutral
Green/Yellow	Earth
2x Black	Safety switch

### Pump Dimensions

Product	Height	Width	Depth	Weight
LOW PROFILE ERRP	75mm	530mm	240mm	2.4kg



## ▶ LOW PROFILE ERRP

**Standing at a height of only 75mm, it is a simple but very effective solution for the removal of water from directly underneath refrigeration units during the auto defrost cycle.**

Ideal for individual refrigeration units with limited space, it is suitable for both the OEM market and for direct installers.

The tank side of the pump has capacity for 3.5 litres of water drained directly from the refrigerator during the auto defrost cycle, which is pumped away quickly through two filters to catch any debris.

The design shares many 'service engineer friendly' features with the larger, established ERRP, including lightweight and easy-to-clean plastic tank and covers, plus a push-in plug and recessed handles at either end to enable easy installation and servicing.



## TECHNICAL SPECIFICATIONS

- Tank capacity: 11L
- Water flow rate: 225L/hr max.
- Max. recommended head: 35m
- Pump rating: 230V AC, 0.35A
- Thermally protected
- High level safety switch
- Filter to catch debris
- Outlet size: 10mm
- Inlet hole to lid: 50mm
- Side inlet option available

### Economy Retail Refrigeration Pump

- Plastic tank/cover
- Lightweight
- Push-in plug
- Handles to enable easy carrying
- Water temperature: 0°C to 40°C
- Single float hall effect switch

### Cold Cabinet

- Stainless steel tank/cover
- Hard-wired
- Water temperature: 0°C to 75°C
- 3 floats & relay

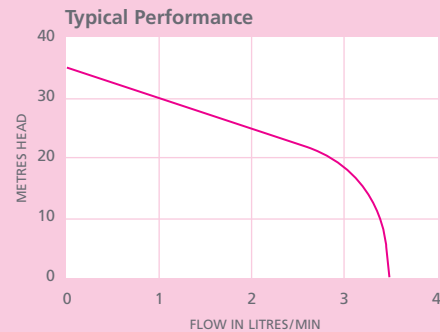

### Service Guide

**IMPORTANT:** Flush the pump through with anti-bacterial wash and clean both filters every 6 months or more often if required, to avoid sludge build-up. Replacement anti-bacterial "Stayclean" strips are recommended and are available from Aspen Pumps.

### Electrical Connections

<b>Brown</b>	Live
<b>Blue</b>	Neutral
<b>Green/ Yellow</b>	Earth
<b>2x Black</b>	Safety switch

### Pump Dimensions

Product	Height	Width	Depth	Weight
<b>COLD CABINET</b>	100mm	585mm	400mm	7.8kg
<b>ERRP</b>	100mm	590mm	405mm	4.9kg



## ▶ ERRP & COLD CABINET

**A simple yet very effective solution for the removal of water from supermarket retail refrigeration units.**

The Retail Refrigeration pumps are low in height which means they can be easily installed underneath a refrigeration unit, where direct drainage is not available and water needs to be pumped up above the ceiling and away to a suitable drain. The high capacity of the pumps also permits the draining of several units together. The pumps are operated by floats which activate sensors as the water level rises in the tank.

Cleaning and maintenance of the pumps is simple, as they can be removed easily from underneath any unit.

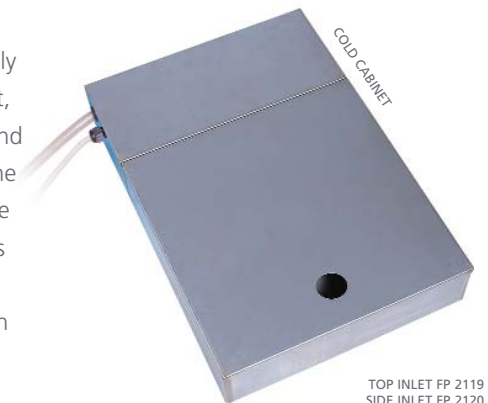

## TECHNICAL SPECIFICATIONS

- Self-priming
- Discharge head: 8.5m
- Water flow rate: 780L/hr max.
- Pump rating: 230V AC, 0.38A
- Connecting cable: 2m
- Pre-wired safety switch 230V, 4.0A max.

### Macerator 4L

- Tank capacity: 4L
- 2 inlet positions in deck: 40mm ø & 55mm ø
- Outlet size: 10mm

### Macerator 12L

- Tank capacity: 12L
- 2 inlet positions in deck: 40mm ø & 55mm ø
- Additional 3/4" inlet connector in tank
- Outlet size: 10mm

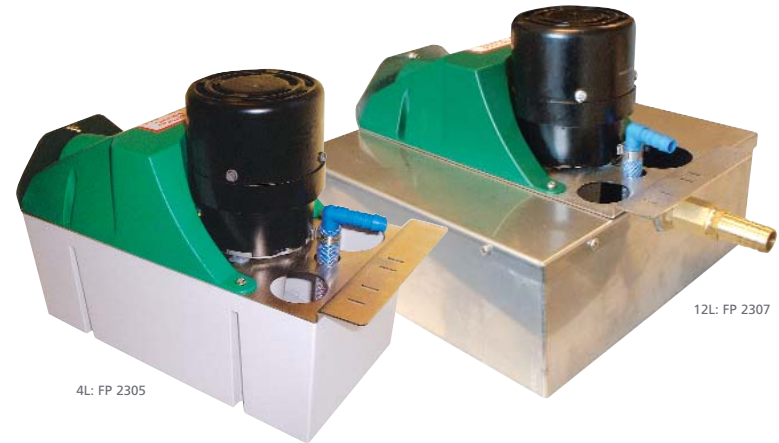

4L: FP 2305

12L: FP 2307

### Macerator Performance

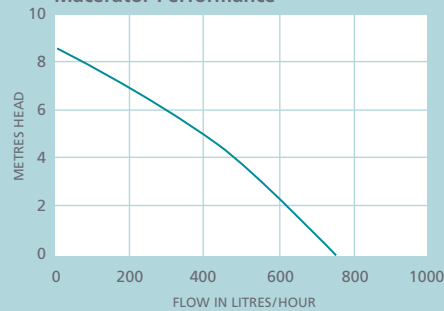

### Service Guide

Flush the pump thoroughly with anti-bacterial wash every 6 months to avoid sludge build-up in the pump housing.

### Electrical Connections

Brown	Live
Blue	Neutral
Green/Yellow	Earth
2x Black	Safety switch

### Pump Dimensions

Product	Height	Width	Depth	Weight
MACERATOR 4L	230mm	335mm	150mm	3.8kg
MACERATOR 12L	230mm	335mm	310mm	6.8kg

## ► MACERATOR PUMP 4L & 12L

The Macerator pump is designed to collect condensation and defrost water from food hall cabinets. It has an internal filter blade to stop the pump from clogging with food debris between maintenance visits and will discharge the water to a head of 8.5 metres.

The internal pre-wired safety float is a low current switch to stop the drain down cycle in the event of pump failure. The pump is operated via two internal float switches.

**The Macerator pump comes in two different tank sizes: The 4 litre, made from plastic and the 12 litre, made in stainless steel.**

**Kitchen.**

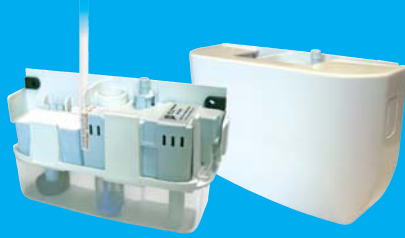

**45kW max.**  
BOILER OUTPUT

Ultra quiet  
Easy inspection  
Mounts under boiler  
10m max. discharge head

FP 2948

**Compact.**



**85kW max.**  
BOILER OUTPUT

Universal design  
Top and bottom inlets  
Free standing or wall mounted  
15m max. discharge head

FP 2944

**Alarm.**



**100kW max.**  
BOILER OUTPUT

Safety cut-out  
Built-in audible alarm  
3.5m max. discharge head

FP 2950

**Hi-Capacity.**



**200kW max.**  
BOILER OUTPUT

Large boiler applications  
4.6m max. discharge head  
Domestic & commercial use

FP 2952



## ▶ BOILER PUMPS

Aspen Pumps, the leading manufacturer of condensate removal pumps has extended its range with a new line of boiler pumps.

The new range incorporates four high efficiency pumps, specifically designed to provide a solution to any kind of application in terms of performance, noise level and aesthetics.

Individual Technical data sheets for the Boiler Pumps are available to download from our website: [www.aspenpumps.com](http://www.aspenpumps.com)

OIL & GAS FIRED  
CONDENSING BOILERS

HIGH EFFICIENCY  
GAS FURNACES

**PERISTALTIC  
SPARE  
TUBE KIT**

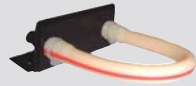

PART NO. FP 1282

**SILICONE  
GREASE**

100g



PART NO. 2457

**MINI AQUA  
BRACKET**



PART NO. 1117

**LIME  
BRACKET**



PART NO. 1116

**PERISTALTIC  
ROTOR  
ASSEMBLY**



PART NO. SA 1382

**PERISTALTIC  
FRONT  
HOUSING**



PART NO. 1159

**MINI BLANC  
BEIGE COVER**



PART NO. FP 1037

**LIME  
INLET HOSE**

1 metre length  
14mm I/D & 19mm O/D



PART NO. 2472

**PERISTALTIC  
STANDARD  
PLUG-IN CABLE**



PART NO. 1523

**PERISTALTIC  
BACK PLATE**



PART NO. SA 1161

**INLINE FILTER (16mm)**

(Bag of 5)

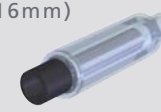

PART NO. FP 2859

**INLINE FILTER**

700 micron mesh  
1/4"-1/4" & 3/8"-3/8"



1/4" (BAG OF 5) FP 2588 3/8" (BAG OF 5) FP 2590  
1/4" (50 PIECES) FP 2545 3/8" (50 PIECES) FP 2646

**3M PERISTALTIC  
UNIVERSAL  
PLUG-IN CABLE**



PART NO. 1573

**PERISTALTIC  
PUMP BRACKET**

For all Aspen peristaltics



PART NO. 1553

**90° HOSE  
CONNECTOR**

(Bag of 5)



PART NO. FP 1023

**OFFSET HOSE  
CONNECTOR**

(Bag of 5)



PART NO. FP 1024

**8M PERISTALTIC  
UNIVERSAL  
PLUG-IN CABLE**



PART NO. 2461

**REDUCING  
CONNECTORS**

1/4" to 3/8"  
(Bag of 5)



PART NO. FP 2632

**VINYL TUBE**

1/4" x 30m clear or braided  
3/8" x 30m clear or braided



PART NO. CLEAR 1/4": 1270 BRAIDED 1/4": 1235  
CLEAR 3/8": 1060 BRAIDED 3/8": 1977

**PUMP TEST  
BOTTLE**

500ml capacity



PART NO. 2811

**STRAIGHT  
CONNECTORS**

1/4" or 3/8"

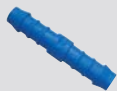

1/4" PART NO. FP 2622 3/8" PART NO. FP 2624 (Bags of 5)

**NON RETURN  
VALVES**

1/4" or 3/8"  
(Bag of 5)



1/4" PART NO. FP 2628 3/8" PART NO. FP 2630

**ANTI BACTERIAL  
TABLET**

(50 per pack)  
18mm ø



PART NO. FP 2418

**STAY CLEAN  
STRIP**

(Bag of 3)



9 x 110 x 25mm  
PART NO. FP 1248

**DRAIN TRAY  
CONNECTOR**

16mm with 18,16 &14mm Pipe fitting ø  
(Bag of 5)



PART NO. FP 2626

**TANK PUMP  
BRACKET**

For Hi-flows & Hi-lifts

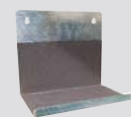

PART NO. SA 1115

**MINI ORANGE  
EXTENSION KIT**



PART NO. 2940

**ACID  
NEUTRALISER**



PART NO. FP 1021

**MINI PUMP  
FLOAT**



PART NO. SA 2459

**COLOURED  
REDUCERS**

With 20,18,16 &14mm Pipe fitting ø  
(Bag of 20)



PART NO. 16mm: FP 2633 18mm: FP 2634 20mm: FP 2635

**SECTION 12  
PUMP ENCLOSURE**

Compatible under Section 12 of London  
Underground specification.



PART NO. 2385



## TECHNICAL SPECIFICATIONS

- Purge facility
- Liquid recovery rate: up to 80kgs/hr
- Vapour recovery rate: up to 30kgs/hr
- Push/pull: up to 320kgs/hr
- 230V & 110V models available
- 500W Oil-less compressor
- High pressure cut out of 410PSIG
- Large condenser and high air flow
- Suitable for most types of refrigerant, both liquid and vapour
- Rugged, moulded case
- Ergonomic carrying handle
- Lightweight at under 13kg

*The EcoWarrior is suitable for refrigerants: R-11, R-12, R-22, R-113, R-114, R-123, R-134A, R-404, R-407C, R-410A, R-500, R-502*



HIGHLY AFFORDABLE

LIGHTWEIGHT

### Dimensions

Product	Height	Width	Depth	Weight
ECOWARRIOR	358mm	395mm	275mm	12.5kg



230V FP 2566  
110V FP 2757

## ▶ ECOWARRIOR

**Highly affordable with no frills on the outside, it's extremely efficient on the inside where it matters.**

With a 500W oil-less compressor, a large condenser and high airflow, the EcoWarrior offers a quick, easy to use solution for recovering refrigerant gases, which is not only an environmental necessity but a legal requirement.

Suitable for most types of refrigerant, the unit has a liquid recovery rate of up to 80kgs/hr, a vapour recovery rate of up to 30kgs/hr, with a purge facility. Lightweight at under 13kg, the EcoWarrior has a clear display panel and a rugged, moulded case with a built-in carry handle to make your life easier.

## TECHNICAL SPECIFICATIONS

### Fan Speed Controller

- Available for cooling only
- Optional heat pump model
- Condenser temperature coil sensor
- Max. output: 3A
- Min. speed setpoint: 30 to 60°C
- Volts: 230V Hertz: 50-60 Hz
- Heat pump model: reversing valve input 24 to 240V AC opto isolated

### 3 Phase Failure + Phase Protection Detector

- Input supply: 300 to 480V AC phase to phase
- Supply frequency: 48-63 Hz
- Temp. range: -20 to 60°C
- Relay output: 8A 250V AC resistive 3A 250V AC inductive 8A 24V DC

### Hi-Level Water Sensor

- Volts: 230V Hertz: 50-60 Hz
- Two sensor operating systems available: condensate sensor or float sensor

## VENTILATION FAN SPEED CONTROLLER

These slim, stylish units are designed for supply/extract ventilation systems.

So many Controllers on the market are bulky and unattractive, but this range from Aspen is designed to be on show... not hidden in a cupboard!

The controller can easily be installed either as a flush-fit unit (recessed) or as a surface mount unit (retro-fit). The fascia and enclosure are designed to be slim and unobtrusive, while the smooth keypad provides a simple interface for the end user, to allow easy control of their local ventilation.



2 AMP FP 2324  
4 AMP FP 2325

### Electrical Specification

- 2 & 4 amp models available
- I230V 50Hz fused
- Maximum ambient temp: 40°C
- IP33 rated

### Dimensions

Product	Height	Width	Depth
VFSC	83mm	154mm	52mm



COOLING FP 2094  
HEATING FP 2095



FP 2098

## FAN SPEED CONTROLLER

Controls head pressure to air conditioning and refrigeration systems by increasing and reducing fan speed with temperature on the condenser coil. There is also a heat pump model for connection to the reversing valve.

## 3 PHASE FAILURE + PHASE PROTECTION DETECTOR

Designed to protect 3 phase motors and industrial equipment from over-heating due to a phase failure. When one phase goes down motors can seem to run normally. It is not until the motor overheats that it is detected, which may be too late.



FP 2131

## HI-LEVEL WATER SENSOR

For utmost security! The versatile Hi-Level Water Sensor is available with two different sensor options:

- Condensate sensor, as used by the Aspen MK4 peristaltic pump (page 40).
- Float sensor, as used by the Aspen Mini Orange pump (page 8) and Mechanical peristaltic pump (page 40).

The Hi-Level Water Sensor can be used in conjunction with most pumps that do not include high level safety. It also has 2 levels of sensing – high and low, both with N.O, N.C & C.

### Dimensions

Product	Height	Width	Depth
FSC	44mm	150mm	75mm
3 PHASE	58mm	90mm	35mm
HI-LEVEL	70mm	125mm	90mm

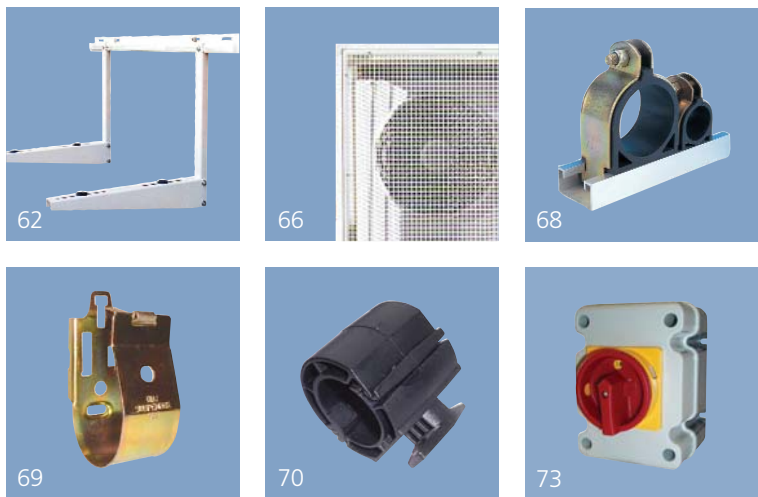

## BBJ ENGINEERING

The BBJ line of products have been developed over a number of years using our extensive knowledge of air conditioning installations. These are designed to complement our extensive range of pumps. This includes condensing unit brackets, protective

guards and a complete range of pipe fixings, all designed to make life easy and quick for the installation engineer.

We offer full sales and technical support from our UK based team who will be pleased to help with any enquiries.

### BRACKETS, GUARDS & BLOCKS

- 62 Type 1 Unit Brackets
- 62 Type 2 Unit Brackets
- 64 Non Metal Brackets
- 64 Quick Fit Brackets
- 65 Industrial Galvanised Arms
- 65 Condensing Unit Drip Trays
- 66 Condensing Unit Guards & Blocks
- 67 Rapid-fit Condensing Unit Guards

### PIPE SUPPORT

- 68 Insulclamps
- 69 Metal Hangers
- 69 Plastic Hangers
- 70 QPC's
- 70 QPH's
- 71 Grip Locks
- 71 Pipe Ties
- 72 Stud Clip
- 72 Channel Clip

### ISOLATORS & GRAVITY DRAINAGE

- 73 Isolators
- 73 Condensate Traps
- 73 Condensate Drain Pipe

### TRUNKING

- 74 Economy Trunking
- 76 Inoac Trunking

## TYPE 1 BRACKET

- 4 sizes available:  
60, 90, 140 or 250kg maximum load
- 3 mounting positions:  
low, central & top  
(Type 1 250kg – single mounting position only)



### Dimensions

Product	Height	Width	Depth
60KG	450mm	-	450mm
90KG	500mm	-	500mm
140KG	550mm	-	550mm
250KG	680mm	-	680mm

PART NO.  
TYPE 1 60kg B6141  
TYPE 1 90kg B6142  
TYPE 1 140kg B6140  
TYPE 1 250kg B6584

## TYPE 2 BRACKET

- 3 sizes available:  
60, 90, 140kg maximum load
- Self-adjusting



### Dimensions

Product	Height	Width	Depth
60KG	430mm	720mm	370mm
90KG	530mm	900mm	470mm
140KG	580mm	1100mm	450mm

PART NO.  
TYPE 2 60kg B6144  
TYPE 2 90kg B6145  
TYPE 2 140kg B6143



## ► CONDENSING UNIT BRACKETS

**BBJ offer a range of easy to install Condensing Unit Brackets that benefit from a high quality finish. They offer a professional appearance and highly economic solution for installations.**

These sturdy and secure Brackets all offer horizontal flexibility. They are designed for easy installation and are boxed complete with all necessary fixings. All steelwork undergoes a 5-part phosphating pre-treatment prior to a 60 micron powder coat finish in ivory.

The Type 1 Brackets are designed to give the choice of 3 positions, enabling the installation of equipment in difficult areas.

The self-adjusting Type 2 Brackets are designed for quick installation and easy levelling on uneven wall surfaces.





## NON METAL BRACKET

- 2 sizes available:  
TYPE 1 80kg maximum load  
TYPE 2 80kg maximum load
- Ideal for use where there is salty sea air



### Dimensions

Product	Height	Width	Depth
TYPE 1	410	-	460
TYPE 2	410	790	460

PART NO.  
TYPE 1 80kg B6760  
TYPE 2 80kg B6761

## INDUSTRIAL GALVANISED ARM

- 2 sizes available:  
450mm (sold as a pair)  
600mm (sold as a pair)



### Dimensions

Product	Height	Width	Depth
SMALL	130	-	450
LARGE	130	-	600

PART NO.  
450mm B6859  
600mm B6860

## QUICK FIT BRACKET

- 3 sizes available:  
60, 90 or 140kg maximum load
- Levelling system
- Adjustable anti-vibration rear foot
- Insulating washer and wall fixing kit supplied



### Dimensions

Product	Height	Width	Depth
60KG	375mm	800mm	420mm
90KG	375mm	800mm	465mm
140KG	375mm	800mm	550mm

PART NO.  
TYPE 2 60kg B6861  
TYPE 2 90kg B6862  
TYPE 2 140kg B6863

## ▶ CONDENSING UNIT DRIP TRAY

- Fits all BBJ Brackets
- Available in 2 sizes
- Metal
- Flat packed with all required fixings (including 15mm tank connector for outlet)



### Dimensions

Product	Width	Depth	Height
SMALL	800mm	400mm	50mm
LARGE	1100mm	400mm	50mm

PART NO.  
SMALL METAL B6147  
LARGE METAL B6146  
SMALL PLASTIC B6591  
LARGE PLASTIC B6592

PART NO.  
SMALL B6192  
MEDIUM B6191  
LARGE B6190

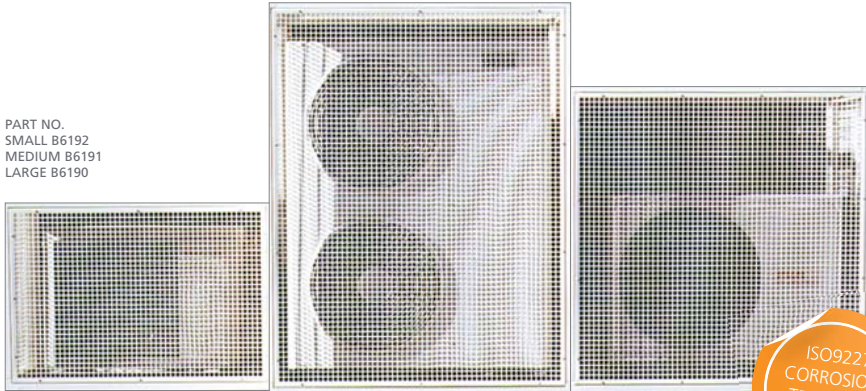

## ▶ CONDENSING UNIT GUARD

**A range of 3 aesthetically pleasing, unobtrusive BBJ Condensing Unit Guards to deter vandalism and prevent damage to valuable equipment.**

The Guards are simple and easy to install, and all panels are removable to allow maintenance of the unit. A back panel is available for free-standing units and extra bottom panels are also available for Guards fixed at high level on walls.

### External Dimensions

Product	Height	Width	Depth
SMALL	700mm	1000mm	450mm
MEDIUM	1100mm	1100mm	600mm
LARGE	1400mm	1100mm	600mm

The Unit Guard framework is a painted aluminium structure and the panels are steelwork, which pass through a 5-part phosphating pretreatment prior to a 60 micron powder coat finish in ivory.

## CONDENSING UNIT BLOCKS

- Adapts to all units
- UPVC
- Maximum load 250kg on one point
- 2 lengths available:  
SB 450mm length (12 per box) including fixings  
SB 1000mm length (12 per box) including fixings



PART NO.  
SB 450mm B6658  
SB 1000mm B6659  
SB Mounting Block End Cap B9381

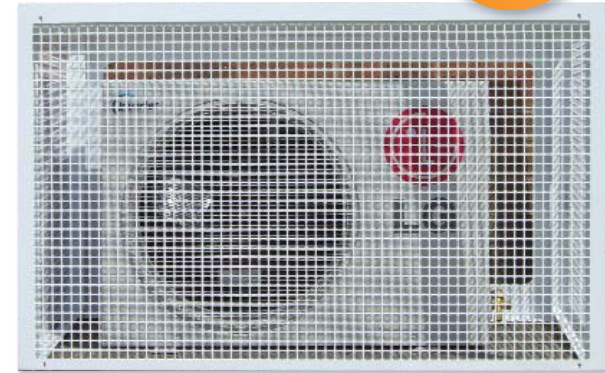

PART NO.  
SMALL B9163  
MEDIUM B9164  
LARGE B9165

## ▶ RAPID-FIT GUARD

**Introducing the new Rapid-fit Condensing Unit Guards. Quick and easy to install, with a simple numbered tab and slot system.**

The guard is secured using 3 tamper resistant screws. Extra bottom panels are also available for guards fixed at high level on walls. The framework is a steelwork structure which passes through a 5-part phosphating pretreatment prior to a 70 micron powder coat finish in ivory.

Three sizes are available and all panels are removable to allow maintenance of the unit.

### External Dimensions

Product	Height	Width	Depth
SMALL	572mm	1052mm	660mm
MEDIUM	572mm	1152mm	1060mm
LARGE	572mm	1152mm	1360mm

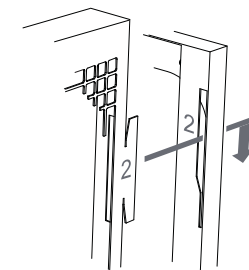

## ▶ PIPE SUPPORT

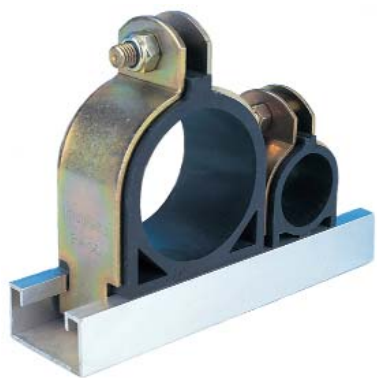

BBJ Insulclamps are a well-known range of pipe clips, supporting individual pipes in a thermo-rubber cushion between two metal parts. Used in the air-conditioning and refrigeration industry, Insulclamps are ideal for bigger commercial installations.

The clamps are made of metal and are therefore safe in the event of a fire if they are fitted in ceiling voids. The Insulclamps can be used both internally and externally.

**BBJ INSULCLAMPS** provide a simple, excellently engineered solution to the problem of effective pipe support.



### Sizes Available & Part Numbers

Size	Part No.	Size	Part No.
1/4"	B6268	1 3/8"	B6265
3/8"	B6274	1 5/8"	B6266
1/2"	B6267	2 1/8"	B6269
5/8"	B6276	2 5/8"	B6270
3/4"	B6273	3 1/8"	B6271
7/8"	B6277	3 5/8"	B6272
1 1/8"	B6264	4 1/8"	B6275

**BBJ HANGERS** are used to support pipe work hanging from ceilings. They hold both liquid and gas lines.

They fit on both M8 and M10 size studding, saving time when supporting pipework or condensate lines. The hangers are adjusted by simply twisting them up or down the rod. They need to be installed every 6ft, and using Hangers means that you no longer need to hang cable trays.



### METAL HANGER SPECIFICATIONS

- Bagged in 10's
- Quick and easy pipe installation
- Avoids the need for cable trays
- 8 microns colour passivation coating
- Use in areas that are fire sensitive

#### Dimensions

Approximate pipe sizes (allowing for insulation)

	BBJ 2 B6492	BBJ 3 B6493	BBJ 4 B6494
LIQUID	3/8"	1/2"	5/8"
GAS	5/8"	7/8"	1 1/8"



**BBJ PLASTIC HANGERS** are the ideal solution to support pipework hanging from ceilings.

This dual stud size clamping system will fit securely to both M8 and M10 studding. Three sizes are available, all offering a wide range of adjustment to fit different insulated pipe diameters.

### PLASTIC HANGER SPECIFICATIONS

- Bagged in 10's
- Quick and easy pipe installation
- Avoids the need for cable trays
- Adjustable clipping mechanism

#### Dimensions

Approximate pipe sizes (allowing for insulation)

	BBJ P2 B6543	BBJ P3 B6544	BBJ P4 B6545
LIQUID	3/8"	1/2"	5/8"
GAS	5/8"	7/8"	1 1/8"

### INSULCLAMP SPECIFICATIONS

- Bagged in 10's (except 3 5/8" and 4 1/8" which are in bags of 5)
- A complete range of 14 sizes to fit 1/4" to 4 1/8" o/d pipes
- Insulates against heat loss and reduces vibration
- Semi-rigid inserts offer good heat resistance
- Quick to install with integral lock nuts
- Plastic inserts designed to withstand temperatures from -25°C to +125°C
- All metal parts are zinc plated and colour passivated to resist corrosion
- Fits into shallow ceiling void or unit
- Fix to 40 x 40mm & 40 x 20mm channel
- **Aluminium channel supplied in either 1 metre (B6000) or 3 metre (B6023) lengths**



**BBJ QUICK POSITIONING CLIPS** are a simple pipe clip made from a UV resistant plastic. They are fitted into standard unistrut channels by just a single twist.

The QPC's are ideal for smaller installations and can be used both externally and internally. They are tidy and give a professional finish to any installation. The thickness of the pipe clip is equal to the wall thickness of the insulation, meaning no break in "vapour barrier".

**Dimensions**

Size	Part No.	3/4"	B6446
1/4"	B6445	7/8"	B6449
3/8"	B6447	1 1/8"	B6442
1/2"	B6444	1 3/8"	B6443
5/8"	B6448	1 5/8"	B6538

**QPC SPECIFICATIONS**

- Bagged in 10's
- A complete range of 9 sizes to fit 1/4" to 1 5/8" o/d pipes
- Easy installation to 40mm x 20mm channel
- External diameter matches diameter of pipes with 9mm insulation
- Material withstands temperatures from -30°C to +135°C
- Excellent resistance to oil

**BBJ QUICK POSITIONING HANGERS** reduce the number of stud clips needed to be kept in stock.

This dual stud size clamping system will fit securely to both M8 and M10 studding. Five sizes are available to fit a wide range of different pipe diameters.

QPH's can support refrigeration pipework, insulated pipes and condensate lines.



**Dimensions**

	No. 1 B6532	No. 2 B6533	No. 3 B6534	No. 4 B6535	No. 5 B6536
COPPER PIPE	1/4" or 3/8"	1/2" or 5/8"	3/4" - 7/8"	1" - 1 1/8"	1 1/4" - 1 3/8"
INSULATED COPPER PIPE	-	-	-	1/4" - 3/8"	1/2" - 5/8"
PLASTIC CONDENSATE	-	-	20mm	25mm	32mm

**BBJ GRIP LOCKS** are particularly good for installers who, when installing the first pipe, can hold it within the BBJ Grip Lock whilst installing the second pipe.

Grip Locks are simple metal pipe clips that hold both liquid and gas lines. Designed to be fitted directly to the wall or solid ceiling, they can hold insulated pipes without a break in the insulation. Installation requires only one screw to be tightened.

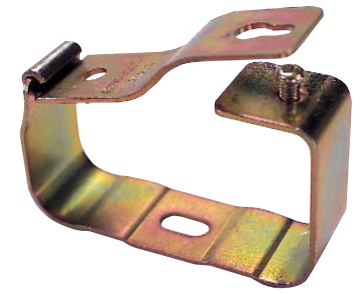

**Dimensions**

Approximate pipe sizes (allowing for insulation)

	Size 1 B6186	Size 2 B6187	Size 3 B6188	Size 4 B6189
LIQUID	1/4"	3/8"	1/2"	5/8"
GAS	1/2"	5/8"	7/8"	1 1/8"

**GRIP LOCK SPECIFICATIONS**

- Bagged in 10's
- Hinged for quick and easy pipe installation
- Wide metal components for good pipe support
- Space for electrical cables and condensate tube
- 8 microns of yellow colour passivate



**BBJ PIPE TIES** are a quick and easy fixing, great for multiple pipework routes. They have a wide tie width to protect pipe insulation.

These simple ties are reusable and also have a fixing hole for securing directly to a wall. Available in 4 lengths to suit various pipe diameters, with a choice of 2 colours.



**Dimensions**

Size	Length	Width	Part No. Black	Part No. White
T250	250mm	20mm	B6551	B6411
T300	300mm	20mm	B6552	B6412
T350	350mm	20mm	B6553	B6413
T400	400mm	20mm	B6554	B6414

## STUD AND CHANNEL CLIPS have a secure and lockable fastening mechanism, allowing quick and easy fixing with the simple fit and twist action.

The unique ratchet design ensures that the clip remains closed when insulated pipe is squeezed against the wall of the clip. The clips are also easy to remove and relocate for maintenance.

### Sizes available & part numbers

Size	M8	M10	30mm	41mm
1/4"	B6800	B6814	B6828	B6842
3/8"	B6802	B6816	B6830	B6844
1/2"	B6801	B6815	B6829	B6843
5/8"	B6803	B6817	B6831	B6845
3/4"	B6804	B6818	B6832	B6846
7/8"	B6805	B6819	B6833	B6847
1"	B6806	B6820	B6834	B6848
1 1/8"	B6807	B6821	B6835	B6849
1 1/4"	B6808	B6822	B6836	B6850
1 3/8"	B6809	B6823	B6837	B6851
1 1/2"	B6810	B6824	B6838	B6852
1 5/8"	B6811	B6825	B6839	B6853
2"	B6812	B6826	B6841	B6854
2 1/8"	B6813	B6827	B6842	B6855



### STUD CLIP SPECIFICATIONS

- Bagged in 10's
- A complete range of 14 sizes to fit 1/4" to 2 1/8" o/d pipes
- Easy installation to M8 and M10 studding
- Fits all types of Metric & Imperial sizing
- Material withstands temperatures from -40°C to +140°C
- Unique lockable ratchet design



### CHANNEL CLIP SPECIFICATIONS

- Bagged in 10's
- A complete range of 14 sizes to fit 1/4" to 2 1/8" o/d pipes
- Easy installation to 30 or 41mm channel
- Fits all types of Metric & Imperial sizing
- Material withstands temperatures from -40°C to +140°C
- Unique lockable ratchet design



## ISOLATORS

- IP 66 electrical isolator for outside use
- 4 types available
- Fitting glands included

PART NO.  
4 POLE 20A B9183  
4 POLE 32A B9184  
4 POLE 40A B9185  
4 POLE 63A B9186

Product	Length	Width	Depth
4 pole 20A	150mm	110mm	120mm
4 pole 32A	150mm	150mm	150mm
4 pole 40A	180mm	120mm	125mm
4 pole 63A	180mm	180mm	180mm

## ROOF INLET

(UK ONLY)

To cover the hole in the roof made to pass through linesets (e.g. insulated copper tubes), connected to an outdoor unit.



PART NO.  
125 x 125mm B9379  
250 x 125mm B9380

## CONDENSATE TRAPS

for air handling units with 3/4" female outlets

### Model EZT-113B

3/4" economy condensate trap



PART NO. FP 2462

### Model EZT-150

"waterless" 3/4" condensate trap



PART NO. FP 2463

### Model EZT-210

3/4" condensate trap with overflow switch



PART NO. FP 2464

### Model EZT-226

3/4" slip fit close-coupled condensate overflow switch



PART NO. FP 2465

## CONDENSATE DRAIN PIPE FIXTURES

(ALL SOLD IN PACKS OF 20)

- 'T' piece
- 90° connector
- 45° connector
- Wall fixing clip
- Straight connector
- 32-25mm reducer
- 25-20mm reducer



The sections of PVC pipe contain 'O' rings which form a secure waterproof seal between fixings when pushed together, with-out the need for gluing.

The drain pipe is available in 3 sizes: 20mm, 25mm and 32mm o/d and comes in 3 metre straight lengths.

## STRAIGHT DUCT

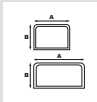

CODE D-70 D-105  
 IVORY B6027 B6026  
 WHITE B6793 B6794

Product code	size (mm)		Overall length	Qty boxed
	A	B		
D.70	70	65	2000	6
D.105	105	75	2000	6

## WALLS COVER FOR INLET OR OUTLET

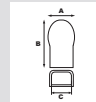

CODE WC-70 WC-105  
 IVORY B6050 B6049  
 WHITE B6789 B6790

Product code	size (mm)			Qty boxed
	A	B	C	
WC.70	110	180	70.4	20
WC.105	145	190	105.4	20

## REDUCER JOINT

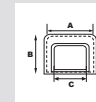

CODE RJ-70-105  
 IVORY B6046  
 WHITE B6787

Product code	size (mm)			Qty boxed
	A	B	C	
RJ.70.105	105.4	80.4	70.4	20

## CONNECTION PIECE

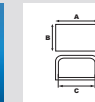
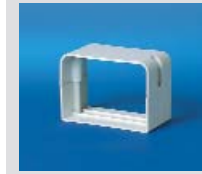

CODE CP-70 CP-105  
 IVORY B6025 B6022  
 WHITE B6771 B6772

Product code	size (mm)			Qty boxed
	A	B	C	
CP.70	75.4	70.4	70.4	20
CP.105	110.4	80.4	105.4	20

## 90° ELBOW BEND

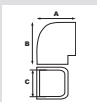

CODE EB-70 EB-105  
 IVORY B6035 B6034  
 WHITE B6777 B6778

Product code	size (mm)			Qty boxed
	A	B	C	
EB.70	95	95	70.4	20
EB.105	110	110	105.4	20

## ELBOW – EXTERNAL 90°

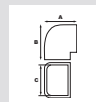
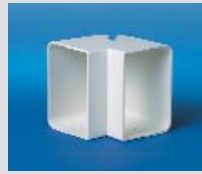

CODE EIN-70 EIN-105  
 IVORY B6037 B6036  
 WHITE B6779 B6780

Product code	size (mm)			Qty boxed
	A	B	C	
EIN.70	95	95	70.4	20
EIN.105	110	110	105.4	20

## 90° FLAT BEND

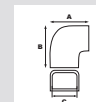

CODE FB-70 FB-105  
 IVORY B6039 B6038  
 WHITE B6781 B6782

Product code	size (mm)			Qty boxed
	A	B	C	
FB.70	115	115	70.4	20
FB.105	150	150	105.4	20

## WALL SLEEVE

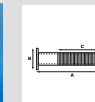
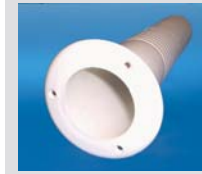

CODE ING-341  
 IVORY B6051

Product code	size (mm)				Qty boxed
	A	B	C	D	
ING.341	350	100	250	63	20

## WALL ROSETTE

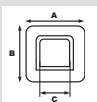

CODE WR-70 WR-105  
 IVORY B6053 B6052  
 WHITE B6791 B6792

Product code	size (mm)			Qty boxed
	A	B	C	
WR.70	115.4	110.4	70.4	20
WR.105	150.4	120.4	105.4	20

## DUCT END

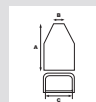

CODE DE-70 DE-105  
 IVORY B6031 B6030

Product code	size (mm)			Qty boxed
	A	B	C	
DE.70	120	45	70.4	20
DE.105	120	50	105.4	20

## T-JOINT

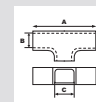

CODE TJ-105  
 IVORY B6048  
 WHITE B6788

Product code	size (mm)			Qty boxed
	A	B	C	
TJ.105	200	105.4	105.4	20

## 45° FLAT BEND

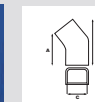
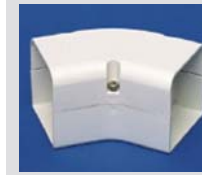

CODE FB-70.45 FB-105-45  
 IVORY B6041 B6040

Product code	size (mm)			Qty boxed
	A	B	C	
FB.70.45	92.58	145.5	70.4	20
FB.105.45	92.58	170.3	105.4	20

## FLAT ROSETTE

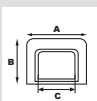

CODE FR-70 FR-105  
 IVORY B6045 B6044  
 WHITE B6785 B6786

Product code	size (mm)			Qty boxed
	A	B	C	
FR.70	115.4	90	70.4	20
FR.105	150.4	100	105.4	20

## FLEXIBLE JOINT

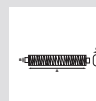

CODE FJ-70 FJ-105  
 IVORY B6043 B6042

Product code	size (mm)			Qty boxed
	A	B	C	
FJ.70	500	65	65	20
FJ.105	500	100	100	20

## DUCT CAP

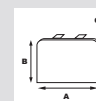
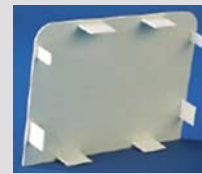

CODE DC-70 DC-105  
 IVORY B6029 B6028  
 WHITE B6773 B6774

Product code	size (mm)			Qty boxed
	A	B	C	
DC.70	70	65	2	20
DC.105	105	75	2	20

Also available:

### ADP.93 DRAIN PIPE (50m)

CODE ADP-93  
 B6020

### CET. CLIPS

CODE CET CLIP  
 B6047

### CCY. CONNECTORS

CODE CCY  
 B6021

## STRAIGHT DUCT

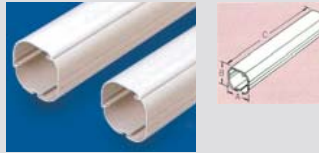

CD-60  
B6200  
CD-75  
B6201  
CD-100  
B6196  
CD-140  
B6199

Product code	size (mm)			Qty boxed
	A	B	C	
CD-60	57.5	58	2000	5
CD-75	74	62	2000	5
CD-100	99	68	2000	5
CD-140	138	78	2000	5

## OUTLET COVER



NW-60  
B6252  
NW-75  
B6253  
NW-100  
B6248  
NW-140  
B6251

Product code	size (mm)					Qty boxed
	A	B	C	D	E	
NW-60	65.5	65	200	77	81	5
NW-75	82	69	210	94	83	5
NW-100	107	75	231	119	96	5
NW-140	146	85	286	158	105	5

## UNIVERSAL ELBOW (VERTICAL)



NZ-60  
B6261  
NZ-75  
B6262

Product code	size (mm)			Qty boxed
	A	B	C	
NZ-60	65.5	65	117.5	5
NZ-75	86	69	122.5	5

## SOCKET



NS-60  
B6237  
NS-75  
B6238  
NS-100  
B6233  
NS-140  
B6236

Product code	size (mm)			Qty boxed
	A	B	C	
NS-60	65.5	65	80	5
NS-75	82	69	80	5
NS-100	107	75	80	5
NS-140	146	85	80	5

## ELBOW (VERTICAL)



NC-60  
B6209  
NC-75  
B6210  
NC-100  
B6206  
NC-140  
B6208

Product code	size (mm)			Qty boxed
	A	B	C	
NC-60	65.5	65	120	5
NC-75	82	69	124	5
NC-100	107	75	135	5
NC-140	146	85	149	5

## WALL CAP



NK-60  
B6223  
NK-75  
B6224  
NK-100  
B6221

Product code	size (mm)				Qty boxed
	A	B	C	D	
NK-60	110	110	16	40	5
NK-75	126	114	16	40	5
NK-100	175	145	16	40	5

## ELBOW (HORIZONTAL)



NE-60  
B6214  
NE-75  
B6215  
NE-100  
B6211  
NE-140  
B6213

Product code	size (mm)			Qty boxed
	A	B	C	
NE-60	65.5	65	119.5	5
NE-75	82	69	141	5
NE-100	107	75	161	5
NE-140	146	85	200	5

## UNIVERSAL ELBOW (HORIZONTAL)



NX-60  
B6258  
NX-75  
B6259  
NX-100  
B6255  
NX-140  
B6257

Product code	size (mm)			Qty boxed
	A	B	C	
NX-60	65.5	65	136.8	5
NX-75	82	69	153	5
NX-100	107	75	193.5	5
NX-140	146	85	248	5

## END SOCKET



NR-60  
B6230  
NR-75  
B6232  
NR-100  
B6228

Product code	size (mm)					Qty boxed
	A	B	C	D	E	
NR-60	53	30	99	65.5	65	5
NR-75	53	30	99	82	69	5
NR-100	53	30	115	107	75	5

## 45° ELBOW (VERTICAL)



NU-60  
B6245  
NU-75  
B6246  
NU-100  
B6244

Product code	size (mm)			Qty boxed
	A	B	C	
NU-60	65.5	65	67	5
NU-75	82	69	72	5
NU-100	107	75	83	5

## T-JOINT



NT-75  
B6243  
NT-100  
B6240  
NT-140  
B6706

Product code	size (mm)					Qty boxed
	A	B	C	D	E	
NT-75	80	70	120	160	25	1
NT-100	107	75	161	215	35	1
NT-140	146	85	200	254	35	1

## 45° ELBOW (HORIZONTAL)



NM-60  
B6226  
NM-75  
B6227  
NM-100  
B6225

Product code	size (mm)			Qty boxed
	A	B	C	
NM-60	65.5	65	68	5
NM-75	82	69	74	5
NM-100	107	75	84	5

## CORNER CAP



NA-60  
B6205  
NA-75  
B6195  
NA-100  
B6203

Product code	size (mm)					Qty boxed
	A	B	C	D	E	
NA-60	67	65	66	105	110	5
NA-75	84	70	66	124	125	5
NA-100	109	76	66	149	140	5

## FLEXIBLE JOINT



NF-60  
B6219  
NF-75  
B6220  
NF-100  
B6216  
NF-140  
B6218

Product code	size (mm)				Qty boxed
	A	B	C	D	
NF-60	59.5	60	60	550	5
NF-75	76	64	60	550	5
NF-100	101	70	75	800	5
NF-140	140	80	80	1000	5

## SADDLE BAND



NV-L  
B6247

Product code	size (mm)		Qty boxed
	A	B	
NV-L	360		10

## REDUCER



NJ-60<75  
B6707  
NJ-75<100  
B6708

Product code	size (mm)					Qty boxed
	A	B	C	D	E	
NJ-60<75	69.5	68	80	82	69	5
NJ-75<100	86	72	80	107	75	5

Also available: NCX-75 VERTICAL/HORIZONTAL ELBOW (B9143)

- Saves you time & reduces cost
- No penetration of roof membrane
- Re-roof without decommissioning plant
- Improves aesthetics
- Install in all weathers

## The complete solution to supporting building services and access equipment on a flat roof

### Frameworks



Quick to install, non-penetrative frameworks designed to meet your individual requirements. Any shape, any size... delivered flat packed for easy on-site management. All we need are your unit sizes, weights and roof plan and we will do the rest.

Angled AV mats (2.5° & 5°) for sloped roofs are available for 305mm & 450mm feet.



### Heavy Duty



Giving you all the options, huge load capacity and total flexibility in load management.

The HD Cube is capable of supporting almost any structure you wish to mount, chillers, plant rooms and water tanks. The Adjustable I Beam is perfect to support large chillers and AHU's where the roof surface is uneven.

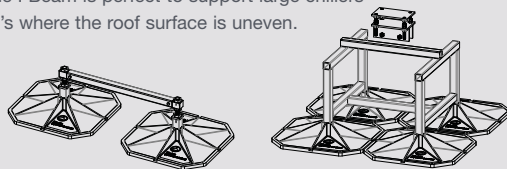

new

### H Frame



No more concrete slabs! Bring your own strut to construct a H Frame in less than 10 minutes, everything else you need comes in the box. Available in 2 Big Foot sizes: 305mm & 450mm.

Pre-assembled H Frame metalwork now available.



### Multi Foot



Versatile support for forming small H frames from 41mm strut, or cable tray supports using M12 threaded rod.

Available in 2 sizes: 400mm & 600mm (with optional AV mats).

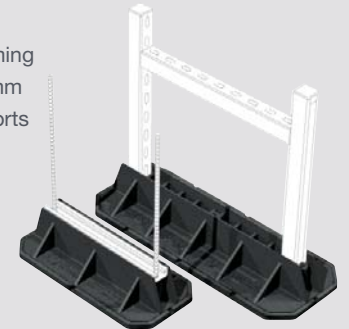

### Fix-it Foot



A sturdy support made from durable recycled rubber, with a 40mm aluminium channel insert. Suitable for all standard strut fixings.

Fix-it Foot available in 4 sizes: 250, 400, 600mm & 1m.

Fix-it Foot Low available in 3 sizes: 250mm, 400mm & 500mm.





## Access

A range of easy to install, modular walkway systems, with gritted fibreglass grating for a permanent non-slip surface in any weather.

Modular Step Overs available with 3, 4 & 5 steps and a range of middle section lengths. The four legs on each step over are adjustable in height, with 450mm feet (and AV mats) for stability.

The Step Over Platform is ideal to allow safe passage over small hazards, e.g. small pipe runs.



## Platforms

Fitted into the top of Big Foot mouldings, these Platforms provide a versatile support system. Available with flat top or with 2 or 4 sides, they have a central M10 threaded insert and are supplied in pairs with Big Feet and AV mats.



## Walkway Slabs

Ideal for walkways and to protect roof surfaces, with underside detail to allow for small debris on roof.



## Solar Systems

We can now offer the complete mounting system for photovoltaic panels on a flat roof. We are continuing to add products to this range, and, as requested by our customers we now produce low cost, robust and quick to install support systems for this growing market. An in-depth brochure is now available to download.



## Swan Necks

A quick and simple solution for when pipe and cables have to penetrate the roof surface. The large flange around the foot of the Swan Neck allows a full seal with the roof membrane. Made from heavy duty aluminum and available in various sizes from stock.

Plastic Roof Inlets available. Please see page 73.



## Vibromats



**AV Strip**  
Multi purpose AV strip  
1000 x 75 x 15mm



**Small Tile**  
Inserted metal plate  
600 x 150 x 30mm



**Large Tile**  
2 Inserted metal plates  
1000 x 500 x 30mm

new

## AV Pad

Offering high grade oil resistant padding, and designed to withstand high loads. Corrugated anti slip rubber.

Sizes range from 51mm x 51mm to 457mm x 457mm – all with a depth of 22.2mm.

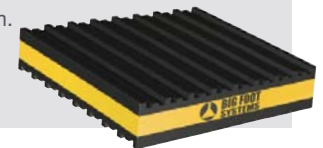

# ENQUIRY FORM

Contact name .....

Company .....

Country .....

Line of Business .....

E-mail .....

Phone .....

# NOTES

.....

.....

.....

.....

.....

.....

.....

.....

.....

.....

Please photocopy and return to our address, or alternatively, email to: [sales@aspenspumps.com](mailto:sales@aspenspumps.com) or fax to +44 (0)1323 848846. Thank you.

# VISIT OUR NEW LOOK WEBSITES...



- MULTI-LANGUAGE • TECH SHEETS • PRODUCT GALLERY • CASE STUDIES
- TECHNICAL HELP ('ASK DR. BOB') • FIND A DISTRIBUTOR IN YOUR COUNTRY
- AND MUCH MORE...

Aspen Pumps  
Apex Way  
Hailsham  
East Sussex  
BN27 3WA  
United Kingdom

t +44 (0)1323 848842  
f +44 (0)1323 848846  
sales@aspenpumps.com  
www.aspenpumps.com



Whilst every care has been taken to ensure that the information included in this document was accurate at the time of printing, we reserve the right to change specifications at any time.

ALL PERFORMANCE DATA IS FOR GUIDANCE ONLY. SUBJECT TO + / -15% TOLERANCE.

8016 ASPEN 7/11

