



CLOSE CONTROL

CW Series

Aurwell



TECHNICAL SPECIFICATIONS

The air conditioners belonging to the “DATA” series have been specifically designed and manufactured for close control air conditioning where the almost exclusive handling of sensible heat loads is a fundamental requirement.

The typical applications are computer rooms, digital telephone exchanges, switch rooms, weather stations, medical laboratories, CAT and MR scanners, as well as any other application where a sensible heat load must be dissipated without modifying the relative humidity.

The series, which can be either upflow or downflow, offers a large range of accessories and variations in design, allowing for maximum flexibility in the use of the units and it has been designed to reduce the footprint.

CW SERIES**Standard Version**

FRAME in painted aluminium profiles. Painted aluminium alloy corner joints.

PANELS (external and internal) in galvanized sheet steel with an external plastic coating. Panels are mounted with stainless steel screws; inspection panels are fitted on hinges and equipped with easy to open locks requiring a separate key.

Room air return grill in galvanized steel with an external plastic coating, for up-flow models only.

AIR-TIGHT GASKETS on panel edges in polyurethane with dual density.

INTERNAL STRUCTURE in galvanized sheet steel.

INTERNAL LINING

Doors: thermal insulation between two aluminium sheets in rigid polyurethane foam class1, non-flammable, 22 mm thickness, density of 47 kg/m³ and a thermal conductivity of, 0.024 W/(m°C).

Panels: in thermo-acoustic open-cell expanded polyurethane, 22 mm thickness for the external panels and 15 mm for the internal ones, self-extinguishing class 1, density of 33 kg/m³ and a thermal conductivity of, 0.036 W/(m°C).

EVAPORATING COIL in copper tubes mechanically expanded into aluminium fins, galvanized steel frame. Air discharge valve on header.

THREE WAY VALVE mounted as mixing on return of chilled water, complete with 3-point (basic microprocessor) or modulating (advanced microprocessor) electric actuator. Valve is assembled in air-flow.

DRAIN PAN in stainless steel with plastic connection to external discharge.

AIR FILTER cleanable type in synthetic fibre, stainless steel frame, G4 efficiency.

SUPPLY AIR CENTRIFUGAL FAN single inlet, backward curved blades, impeller statically and dynamically balanced, directly coupled to electric motor (external rotor type) with built-in overload protection each fan is assembled in separate hood. Speed adjustment by 4-speed autotransformer or directly by microprocessor, depending on unit model. Settings can be effected on site.

AIR FLOW SWITCH on room supply air fan.

ELECTRIC CONTROL PANEL complete with:

- Main interlocking power switch.
- Automatic fuse protections are each single utility.
- Fan motor contactors or speed regulation board, depending on unit model.
- Auxiliary services transformer.
- Components and wiring in compliance with applicable IEC Norms.

MICROPROCESSOR CONTROL for single or multi-unit management system, with the following characteristics:

- room air temperature control through the modulation of the three way valve or the electric heater (option)
- supply air temperature limit (optional)
- management of all alarm conditions
- remote start-stop
- general alarm
- password

USER INTERFACE for the display of unit conditions, status and operating parameters, with the following characteristics:

- display of room temperature and temperature set-point for supply air
- display of operating parameters
- control keyboard with two levels of "password"
- alarm reset and unit set-up
- on/off safety switch
- watchdog function

FACTORY TESTS AND INSPECTION

ACCESSORIES AND OPTIONS

DIFFERENTIAL PRESSURE SWITCH for clogged filter alarm.

WATER LEAKAGE ALARM complete with control relay and two sensors to be installed in the raised floor.

FIRE ALARM consisting of an optical sensor to detect presence of smoke and directly wired to the microprocessor.

ELECTRIC REHEATING COIL one, two or three stages, available depending on the size and manufactured in extruded aluminium; complete with contactor, thermal overload protection and safety thermostat. It is controlled directly by the microprocessor.

HOT WATER REHEATING COIL made with copper tubes mechanically expanded into aluminium fins, galvanized steel frame. Available with one row.

THREE WAY VALVE mounted as mixing on return of hot water, complete with 3-point (basic microprocessor) or modulating (advanced microprocessor) electric actuator.

STEAM HUMIDIFIER immersed electrodes type, modulating version, complete with probe mounted on the return air and with microprocessor control card.

DEHUMIDIFICATION SYSTEM effected with double speed of fan/s Humidity probe on return air.

FRESH AIR INTAKE KIT separately supplied for assembly on site. It is composed of a container with G4 air filter; the container is equipped with a circular connection (80mm dia.) that has to be connected to the fresh air duct. Drilling and flexible connection with diameter of 100mm are to be effected by the contractor. Max available air flow 0,04 m³/sec.

REAR RETURN AIR INTAKE only for up-flow models. Closed front panel and return air intake on the rear side with flange for connection to the duct system.

SUPPLY AIR CENTRIFUGAL FAN single inlet, backward curved blades, impeller statically and dynamically balanced, directly coupled to brushless electric motor EC (electronically commutated) type with built-in overload protection.

AIR DELIVERY PLENUM frame in painted aluminium profiles and panels in galvanized steel sheet with external plastic coating, internally lined with thermo acoustic polyurethane open cell foam, complete with a grill with a double row of adjustable fins. Can be supplied with front diffuser grill only or with front and side grills.

BASE FRAME made in strong painted steel welded profiles and is equipped with adjustable pedestals (adjustment 50 mm) and air deflector. The height, has to be indicated by the mechanical contractor, and can be comprised between 150 and 700 mm. Special versions having gravity or motorized damper, or silenced can be supplied on request.

NON-RETURN DAMPER with aluminium fins fitted on nylon bushings.

TEMPERATURE + HUMIDITY MICROPROCESSOR complete with card and probe for relative humidity control on return air. The accessory also includes the dehumidification system described above.

CLOCK MODULE accessory for microprocessor, necessary for alarm reports and and history of alarm situations.

ADVANCED MICROPROCESSOR high performance 16 bit programmable control. It is used when customized programmes are required, or an increased number of alarms, or advanced functions for LAN connections.

ADVANCED MICROPROCESSOR for **TEMPERATURE + HUMIDITY** control, complete with card and probe for relative humidity control on return air and the dehumidification system.

AIR FILTER having efficiency F5 or F7 installed instead of the standard filters. Made in synthetic fibre with stainless steel frame are not washable type.

SPECIAL COILS with an anti corrosion surface treatment.

ACCESSORIES AND OPTIONS

INTERNAL LINING of the panels in double layers of open-cell polyurethane foam with interposed lead sheet, weight of 6.3 kg/m^2 , 22 mm thickness for external panels and 15 mm for internal ones. It has the same thermal insulation characteristics of the standard and improves of 4 dB (A) the noise of the unit.

SANDWICH PANELS external in galvanized steel sheet plastic coated, internal in galvanized steel sheet. Thermal insulation between the two metal sheets in polyurethane foam class1, non-flammable and conductivity $0.024 \text{ W/(m } ^\circ\text{C)}$. It has the same thermal insulation characteristics of the standard and improves of 4 dB (A) the noise of the unit. Can be used when high pressure fans are required.

SERIAL OUTPUT CARD RS 485 can be used with both models of micro-processor.



COOLING CAPACITY

ROOM AIR CONDITIONS °C - %RH

Size	Th	20-50		22-50		24-50		26-50	
		Ct	Cs	Ct	Cs	Ct	Cs	Ct	Cs
	°C	kW	kW	kW	kW	kW	kW	kW	kW
21	7	11.1	11.1	12.7	12.7	15.1	13.8	18.2	14.7
	9	9.5	9.5	11.2	11.2	12.9	12.9	16.3	13.7
	10	8.6	8.6	10.4	10.4	12.1	12.1	13.8	11.5
	12	7.0	7.0	8.7	8.7	10.5	10.5	12.2	10.2
31	7	16.4	16.3	21.1	18.3	25.8	22.6	31.0	22.1
	9	14.3	14.3	16.9	16.9	20.9	18.3	26.0	20.1
	10	13.0	13.0	15.6	15.6	18.5	16.1	23.4	18.1
	12	10.4	10.4	13.0	13.0	15.6	13.6	18.3	14.1
41	7	22.6	21.8	28.9	24.5	35.5	30.2	42.4	29.7
	9	19.3	19.3	22.3	21.8	28.8	24.5	35.7	27.1
	10	17.5	17.5	20.9	20.5	25.5	21.7	32.3	24.5
	12	14.1	14.1	17.5	17.2	20.9	17.8	25.2	19.1
51	7	31.7	31.3	40.6	35.1	49.8	42.7	59.7	42.4
	9	27.5	27.5	32.3	32.3	40.5	35.1	50.2	38.7
	10	25.0	25.0	29.9	29.9	35.7	30.9	45.3	34.9
	12	20.0	20.0	25.0	25.0	29.9	25.9	35.3	27.2
61	7	36.8	36.3	47.0	40.8	57.8	51.1	69.2	49.2
	9	31.9	31.9	37.6	37.6	46.7	40.7	58.2	45.0
	10	29.1	29.1	34.8	34.8	41.3	36.0	52.5	40.6
	12	23.3	23.3	29.0	29.0	34.7	30.2	40.9	31.6
42	7	26.0	26.0	32.0	28.3	39.4	33.5	47.2	34.0
	9	22.0	22.0	26.0	26.0	32.0	28.3	39.6	31.2
	10	20.0	20.0	24.0	24.0	28.1	24.8	35.8	28.2
	12	16.0	16.0	20.0	20.0	23.9	21.1	27.9	21.9
52	7	31.2	30.8	39.9	34.6	49.2	41.8	59.1	42.0
	9	27.2	27.2	31.0	31.0	40.1	34.7	49.9	38.4
	10	24.9	24.9	29.7	29.7	35.6	30.8	45.2	34.8
	12	20.0	20.0	24.9	24.9	29.7	25.7	35.2	27.1
62	7	38.7	38.3	49.6	43.0	60.8	49.7	72.8	51.8
	9	33.6	33.6	39.7	39.7	49.4	42.9	61.1	47.3
	10	30.6	30.6	36.6	36.6	43.4	37.7	55.1	42.7
	12	24.5	24.5	30.6	30.6	36.6	31.8	43.0	33.3
82	7	52.9	52.2	67.5	58.5	83.0	67.9	99.4	70.6
	9	45.7	45.7	54.0	54.0	67.3	58.4	83.5	64.4
	10	41.7	41.7	49.9	49.9	59.4	51.5	73.8	56.4
	12	33.4	33.4	41.6	41.6	49.8	43.2	58.7	45.3
102	7	60.3	59.5	77.1	66.7	94.8	78.0	113.6	80.6
	9	52.2	52.2	61.5	61.5	77.0	66.7	95.4	73.6
	10	47.5	47.5	56.8	56.8	67.8	58.8	86.1	66.4
	12	37.9	37.9	47.5	47.5	56.8	49.2	67.1	51.8
112	7	70.6	70.2	90.1	78.7	110.8	95.8	132.6	94.8
	9	61.5	61.5	72.5	72.5	89.8	78.6	111.3	86.6
	10	56.1	56.1	67.0	67.0	79.1	69.2	100.5	78.2
	12	44.9	44.9	56.0	56.0	66.9	58.6	78.2	60.9
152	7	100.8	100.8	124.2	109.4	152.8	128.9	182.8	131.6
	9	85.5	85.5	100.8	100.8	123.8	109.4	153.5	120.5
	10	77.8	77.8	93.1	93.1	109.1	96.4	138.4	108.6
	12	62.4	62.4	77.7	77.7	93.0	82.2	107.8	84.6

Th - Inlet chilled water temperature/Constant nominal flow

Ct - Total cooling capacity

Cs - Sensible cooling capacity

The fan power input has not been subtracted from the capacities indicated above.

MAIN TECHNICAL DATA

Data Series	Size		21	31	41	51	61	42
	TOTAL COOLING CAPACITY (1)	kW	15.1	25.8	35.5	49.8	57.8	39.4
	SENSIBLE COOLING CAPACITY (1)	kW	13.8	22.6	30.2	42.7	51.1	33.5
SUPPLY FAN	NOMINAL AIR FLOW	m³/s	1.11	1.45	1.81	2.78	3.33	2.36
	EXTERNAL STATIC PRESSURE	Pa	250	150	100	200	120	200
	POWER INPUT	kW	1.1	1.2	1.4	2 X 1.2	2 X 1.5	1.6
	ENGAGED ELECTRIC POWER	kW	1.5	1.5	1.5	2 X 1.5	2 X 1.5	2.3
COOLING COIL	FACE AREA	m²	0.49	0.70	1.13	1.32	1.51	1.11
	ROWS NUMBER	n	3	3	3	3	3	3
	FIN SPACING	mm	1.6	1.6	1.6	1.6	1.6	1.8
	NOMINAL CHILLED WATER FLOW	l/s	0.72	1.23	1.70	2.38	2.76	1.88
	NOMINAL WATER PRESSURE DROP	kPa	22	44	31	44	52	38
THREE WAY VALVE	CONNECTION SIZE	"	3/4"	1"	1"1/4	1"1/4	1"1/2	1"1/4
	WATER PRESSURE DROP	kPa	23	21	21	29	16	18
TOTAL WATER PRESSURE DROP		kPa	45	65	52	73	68	56
DIMENSIONS	LENGTH	mm	650	840	1238	1428	1618	860
	WIDTH	mm	650	650	650	650	650	860
	HEIGHT	mm	1970	1970	1970	1970	1970	1980
SOUND PRESSURE LEVEL	UP-FLOW	dB (A)	54.5	56	58.5	59.0	61.5	58.0
	DOWN-FLOW (2)		50.5	52	54.5	55.0	57.5	54.0
OPERATING WEIGHT		kg	160	210	280	330	380	270

(1) Capacities referred to:

Room air conditions +24°C/ 50%RH
 Chilled water temperature +7/12°C

(2) Sound pressure level measured a 2 mt from the unit, 1 m height, in free field conditions

The fan power input has not been subtracted from the capacities indicated above.

MAIN TECHNICAL DATA

Data Series	Size		52	62	82	102	112	152
	TOTAL COOLING CAPACITY (1)	kW	49.2	60.8	83	94.8	110.8	152.8
	SENSIBLE COOLING CAPACITY (1)	kW	41.8	49.7	67.9	78	95.8	128.9
SUPPLY FAN	NOMINAL AIR FLOW	m³/s	2.72	3.75	4.86	5.56	6.94	10.0
	EXTERNAL STATIC PRESSURE	Pa	100	100	200	250	200	200
	POWER INPUT	kW	2.0	2 x 1.4	2 x 1.6	2 x 2.6	2 x 3.5	3 x 3.4
	ENGAGED ELECTRIC POWER	kW	2.3	2 x 1.5	2 x 2.3	2 x 3.9	2 x 3.9	3 x 3.9
COOLING COIL	FACE AREA	m²	1.79	2.11	2.81	3.37	3.37	4.52
	ROWS NUMBER	n	3	3	3	3	3	3
	FIN SPACING	mm	1.8	1.8	1.8	1.8	1.8	1.8
	NOMINAL CHILLED WATER FLOW	l/s	2.35	2.90	3.97	4.53	5.29	7.30
	NOMINAL WATER PRESSURE DROP	kPa	29	60	42	50	57	63
THREE WAY VALVE	CONNECTION SIZE		1"1/2"	1"1/2"	2"	2"	2"	2 x 1"1/2
	WATER PRESSURE DROP	kPa	15	18	13	17	23	28
TOTAL WATER PRESSURE DROP		kPa	44	78	55	67	80	91
DIMENSIONS	LENGTH	mm	1258	1448	1885	1885	2265	2853
	WIDTH	mm	860	860	860	860	860	860
	HEIGHT	mm	1980	1980	1980	1980	1980	1980
SOUND PRESSURE LEVEL	UP-FLOW	dB (A)	60.0	62.0	65.0	63.0	64.0	67.0
	DOWN-FLOW (2)		56.0	58.0	61.0	59.0	60.0	63.0
OPERATING WEIGHT		kg	330	380	470	540	600	720

(1) Capacities referred to:

Room air conditions +24°C/ 50%RH
 Chilled water temperature +7/12°C

(2) Sound pressure level measured a 2 mt from the unit, 1 m height, in free field conditions

The fan power input has not been subtracted from the capacities indicated above.

HOT WATER HEATING COIL CAPACITY

Size	Th	ROOM AIR CONDITIONS °C								
		15			17			20		
	°C	Cr	Ph	Dp	Cr	Ph	Dp	Cr	Ph	Dp
21	80/70	17.3	0.43	4	16.7	0.41	4	15.7	0.39	3
	80/65	15.6	0.26	2	15.0	0.24	2	14.0	0.23	1
31	80/70	24.3	0.60	9	23.4	0.57	8	22.0	0.54	8
	80/65	22.3	0.36	4	21.4	0.35	4	20.1	0.33	3
41	80/70	36.0	0.88	26	34.7	0.85	24	32.7	0.80	22
	80/65	33.7	0.55	11	32.4	0.53	11	30.4	0.50	9
51	80/70	48.8	1.20	50	47.0	1.15	47	44.4	1.09	42
	80/65	45.7	0.75	22	44.0	0.72	21	41.4	0.67	18
61	80/70	57.8	1.42	75	55.7	1.37	71	52.6	1.29	64
	80/65	54.7	0.89	33	52.2	0.85	31	49.2	0.80	28
42	80/70	23.4	0.57	3	22.5	0.55	3	21.2	0.52	3
	80/65	21.1	0.35	1	20.3	0.33	1	19.0	0.31	1
52	80/70	33.4	0.82	8	32.2	0.79	7	30.4	0.74	7
	80/65	31.0	0.51	3	29.8	0.48	3	27.9	0.46	3
62	80/70	43.3	1.07	14	41.8	1.02	13	39.4	0.97	12
	80/65	40.3	0.66	6	38.7	0.63	6	36.4	0.59	5
82	80/70	57.2	1.40	28	55.1	1.35	27	52.0	1.28	24
	80/65	53.6	0.87	13	51.5	0.84	12	48.4	0.79	11
102	80/70	61.2	1.50	32	59.0	1.45	30	55.7	1.36	27
	80/65	57.3	0.93	14	55.1	0.90	13	51.8	0.84	12
112	80/70	76.5	1.87	56	73.8	1.81	52	69.7	1.71	47
	80/65	72.0	1.17	25	69.2	1.13	23	65.1	1.06	21
152	80/70	102.5	2.51	17	98.7	2.42	16	93.1	2.28	15
	80/65	95.2	1.55	8	91.5	1.49	7	86.0	1.40	6

Th - Water temperature (°C)
 Cr - Heating capacity (kW)
 Ph - Water flow (l/s)
 Dp - Pressure drop (kPa)

ELECTRIC HEATER CAPACITY

		SIZE											
		21	31	41	51	61	42	52	62	82	102	112	152
Single stage	Kw	4.5	6	9	9	12	12	18	18	18	18	24	24
Two stages	Kw	2.7/4.5	3.6/6	5.4/9	5.4/9	7.2/12	7.2/12	10.8/18	10.8/18	10.8/18	10.8/18	14.4/24	14.4/24
Three stages	Kw	1.8/2.7/4.5	2.4/3.6/6	2.4/3.6/6	3.6/5.4/9	4.8/7.2/12	4.8/7.2/12	7.2/10.8/18	7.2/10.8/18	7.2/10.8/18	7.2/10.8/18	9.6/14.4/24	9.6/14.4/24
FLA*	A	6.5	8.7	13.0	13.0	17.3	17.3	26.0	26.0	26.0	26.0	34.6	34.6

* Referred to single stage heater

HUMIDIFIER

		SIZE											
		21	31	41	51	61	42	52	62	82	102	112	152
Max steam production	kg/h	3	8	8	8	8	8	8	8	8	8	15	15
Full load power input	kW	2.3	6.0	6.0	6.0	6.0	6.0	6.0	6.0	6.0	6.0	11.3	11.3
Full load current	A	3.3	8.7	8.7	8.7	8.7	8.7	8.7	8.7	8.7	8.7	16.3	16.3
Water conductivity min-max	µS/cm²	125 - 1250											
Water suppli pipe diam	"G	3/4"											
Min int. diam. humid. supply	mm	6											
Water drain pipe diam.	mm	32											

PERFORMACES OF DIRECT DRIVE BACKWARD-BLADE FANS

External static pressure		SIZE											
Pa		21	31	41	51	61	42	52	62	82	102	112	152
50	rpm	1050	1100	1300	1100	1300	1200	1250	1300	1200	1050	1100	1100
	kWa	1.1	1.2	1.4	2 x 1.2	2 x 1.4	1.6	2.0	2 x 1.4	2 x 1.6	2 x 2.6	2 x 2.8	3 x 2.8
100	rpm	1100	1250	1350	1250	1350	1250	1350	1350	1250	1150	1200	1200
	kWa	1.2	1.3	1.5	2 x 1.3	2 x 1.5	1.8	2.3	2 x 1.5	2 x 1.8	2 x 3.0	2 x 3.3	3 x 3.3
150	rpm	1250	1300	-	1300	-	1300	-	-	1300	1250	1300	1300
	kWa	1.3	1.5	-	2 x 1.5	-	2.1	-	-	2 x 2.1	2 x 3.5	2 x 3.9	3 x 3.9
	m³/s	1.23	1.75	2.83	3.30	3.78	2.78	4.48	5.28	7.03	8.43	8.43	11.30

rpm - Fan speed (Nominal air flow)

kWa - Fan motor power input

m³/s - Max available air flow

WATER CONNECTIONS

		SIZE											
		21	31	41	51	61	42	52	62	82	102	112	152
3-way cooling coil valve	"	3/4"	1"	1.1/4"	1.1/4"	1.1/2"	1.1/4"	1.1/2"	1.1/2"	2"	2"	2"	2 x 1.1/2"
Nominal pressure drop	kPa	45	65	52	73	68	56	44	78	55	67	80	91
Chilled water connections	"G	1"	1.1/4"	1.1/2"	1.1/2"	1.1/2"	1.1/4"	1.1/2"	1.1/2"	2"	2"	2"	2 x 2"
3-way heating coil valve	"	1/2"	3/4"	1"	1"	1.1/4"	1/2"	3/4"	1"	1"	1.1/4"	1.1/4"	1/2"
Nominal pressure drop	kPa	17	18	30	57	72	23	23	24	33	37	62	26
Hot water connections	"G	1/2"	3/4"	1"	1"	1"	1"	1"	1"	1.1/4"	1.1/4"	1.1/4"	1.1/2"
Humidifier water supply	"G	3/4"	3/4"	3/4"	3/4"	3/4"	3/4"	3/4"	3/4"	3/4"	3/4"	3/4"	3/4"
Min int. diam. humid. supply	mm	6	6	6	6	6	6	6	6	6	6	6	6
Humidifier water drain	mm	32	32	32	32	32	32	32	32	32	32	32	32
Condensate drain	mm	20	20	2 x 20	2 x 20	2 x 20	2 x 20	4 x 20	4 x 20	4 x 20	4 x 20	4 x 20	4 x 20

ELECTRICAL DATA

		SIZE											
		21	31	41	51	61	42	52	62	82	102	112	152
Full load power input (1)	kW	8.3	13.5	16.5	21.0	24.0	18.3	20.3	27.0	31.6	34.8	43.1	50.0
FLA (1)	A	16.4	24.0	28.3	32.6	37.0	27.3	30.2	41.3	47.4	51.8	63.7	74.5
Backward-blade fan	n x kW	1.5	1.5	1.5	2 x 1.5	2 x 1.5	2.3	2.3	2 x 1.5	2 x 2.3	2 x 3.9	2 x 3.9	3 x 3.9
LRA	A	12.5	12.5	12.5	12.5	12.5	18.0	18.0	12.5	36.0	52.0	52.0	78.0
Copper wire size (2)	5 x mm ²	10	10	16	16	16	10	16	25	25	25	25	25
Electrical supply	V/ph/Hz	400 ± 10% / 3 + N/50											

(1) - At the maximum operating admitted conditions
Unit complete with humidifier and electric heater

For the operating data please refer to the unit wiring diagram.

(2) - Wire size valid for distances up to 30 mt
max. voltage drop 3%

AIR FILTERS

			SIZE											
			21	31	41	51	61	42	52	62	82	102	112	152
Upflow	Quantity	n	1	1	2	2	2	2	2	4	6	6	6	8
	Dimensions	mm x mm	545 1000	735 1000	545 1000	660 1000	750 1000	445 655	635 655	2 x 445 + 2 x 635 655	445 655	445 655	2 x 445 + 4 x 635 655	4 x 445 + 4 x 455 655
	Thickness	mm	48	48	48	48	48	48	48	48	48	48	48	48
Downflow	Quantity	n	1	1	2	2	2	1	2	3	5	5	6	6
	Dimensions	mm x mm	545 595	735 595	565 595	660 595	755 595	735 800	565 800	440 800	350 800	350 800	355 800	455 800
	Thickness	mm	98	98	98	98	98	98	98	98	98	98	98	98

OPERATING RANGE

		SIZE											
		21	31	41	51	61	42	52	62	82	102	112	152
Air flow m ³ /s	Min	0.69	0.98	1.58	1.85	2.11	1.55	2.51	2.95	3.93	4.72	4.72	6.39
	Max	1.23	1.75	2.83	3.30	3.78	2.78	4.48	5.28	7.03	8.43	8.43	11.30
Max hydraulic pressure	kPa	600											
Max Dp on valve	kPa	200	200	150	150	250	150	400	400	250	250	250	400

Please contact our Technical Dept. for 2-way valves limits.

FATTORE DI CORREZIONE GLICOLE / GLYCOL CORRECTION FACTORS

Percentuale glicole - Glycol percentage		0%	10%	20%	30%	40%	50%
Punto di congelamento Freezing point	°C	0	-5	-10	-15	-20	-30
Fattore di resa Capacity factor		1	0.98	0.95	0.93	0.91	0.88
Fattore di portata acqua Water flow factor		1	1.01	1.04	1.08	1.14	1.20
Fattore perdita di carico Pressure drop factor		1	1.05	1.13	1.21	1.26	1.32

DIMENSIONS AND WEIGHTS

PACKING - PLENUM - BASEFRAME - FLOOR HOLE

SIZE (mm)						
	21	31	41	51	61	42
A	700	700	700	700	700	900
B	700	900	1300	1500	1700	900
C	2120	2120	2120	2120	2120	2130
D	650	840	650	840	840	840
E	650	840	1238	1428	1618	860
F	650	650	650	650	650	860
G	600	600	600	600	600	600
H*	150 700	150 700	150 700	150 700	150 700	150 700
I	590	780	1178	1368	1558	780
J	590	590	590	590	590	780
K	550	740	1138	1328	1518	740
L	530	530	530	530	530	720
Kg**	170	220	290	340	390	280

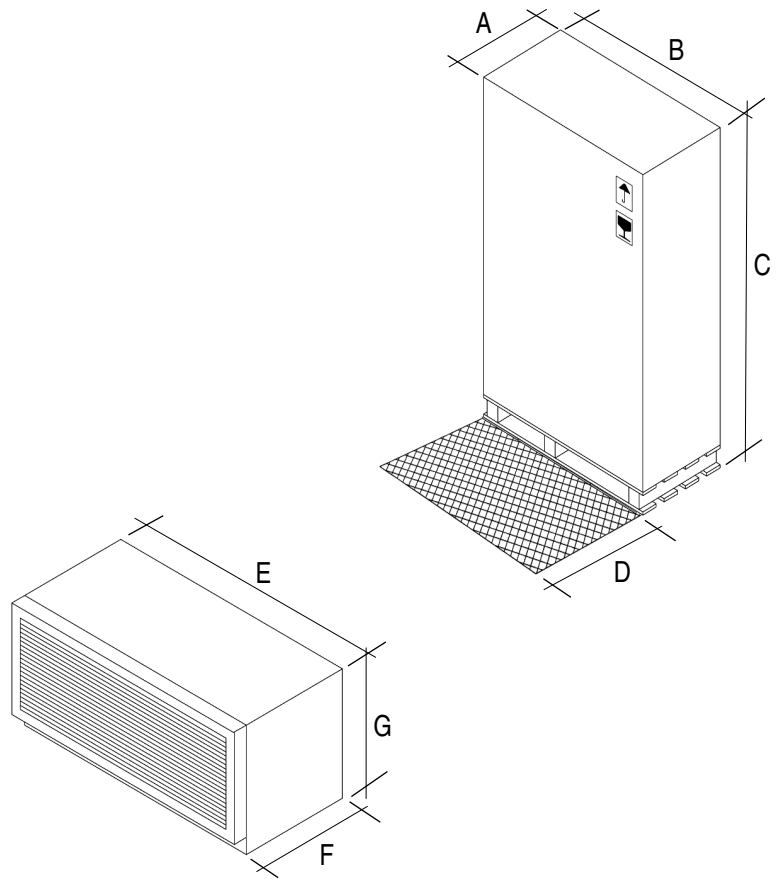

	52	62	82	102	112	152
A	900	900	900	900	900	900
B	1300	1500	1950	1950	2350	2950
C	2130	2130	2130	2130	2130	2130
D	650	840	650	650	840	840
E	1258	1448	1885	1885	2265	2853
F	860	860	860	860	860	860
G	600	600	600	600	600	600
H*	150 700	150 700	150 700	150 700	150 700	150 700
I	1178	1368	1805	1805	2185	2776
J	780	780	780	780	780	780
K	1138	1328	1765	1765	2145	2736
L	720	720	720	720	720	720
Kg**	340	390	480	550	610	730

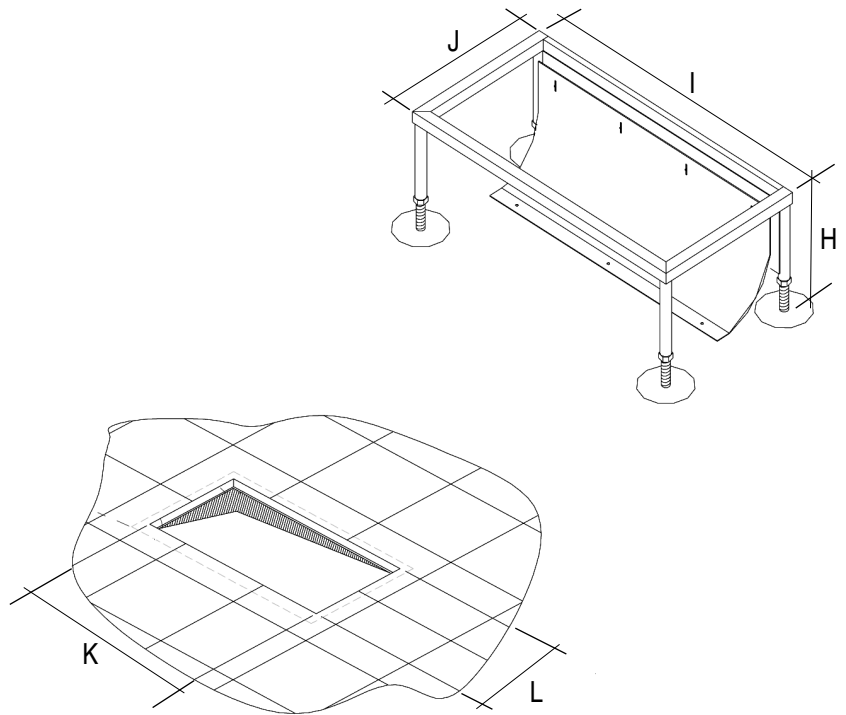

* The eight has to be indicated by the mechanical contractor; adjustment 50 mm.
 ** Shipping weight

DOWN-FLOW VERSION

Vista frontale
Front view

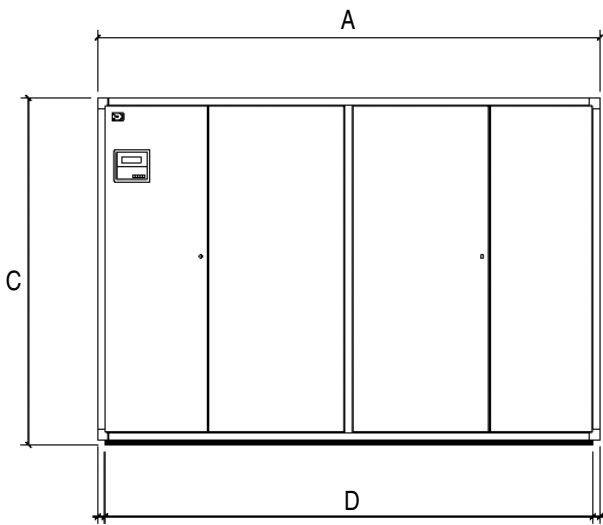

Vista laterale
Side view

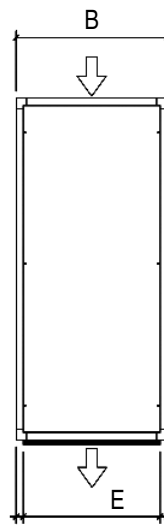

Vista dal basso - Bottom view

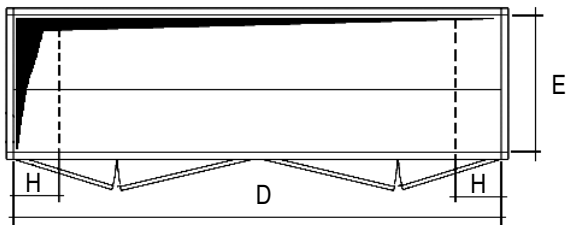

Layout
Frontale - Front

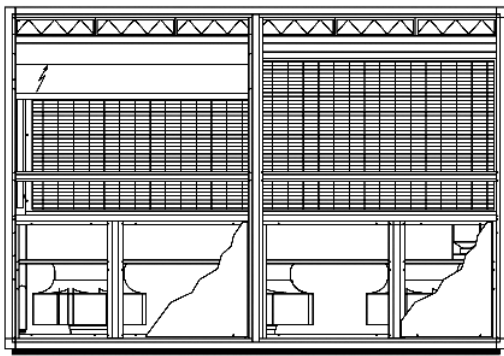

Layout
Laterale - Side

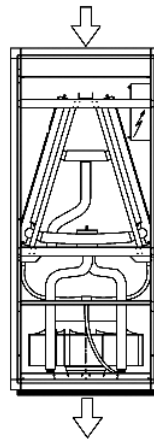

Vista dall'alto - Upper view

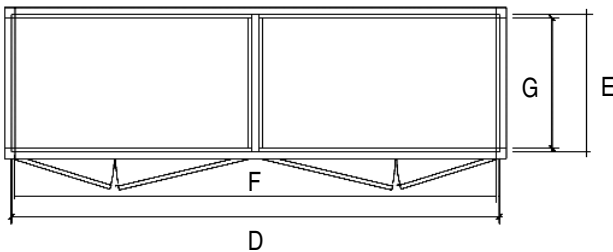

SIZE (mm)						
	21	31	41	51	61	42
A	650	840	1238	1428	1618	860
B	650	650	650	650	650	860
C	1970	1970	1970	1970	1970	1980
D	590	780	1178	1368	1558	780
E	590	590	590	590	590	780
F	552	742	1140	1330	1520	740
G	552	552	552	552	552	740
H	150	150	150	150	150	150

UP-FLOW VERSION

	52	62	82	102	112	152
A	1258	1448	1885	1885	2265	2853
B	860	860	860	860	860	860
C	1980	1980	1980	1980	1980	1980
D	1178	1368	1805	1805	2185	2773
E	780	780	780	780	780	780
F	1138	1328	1765	1765	2145	2733
G	740	740	740	740	740	740
H	150	150	150	150	150	150

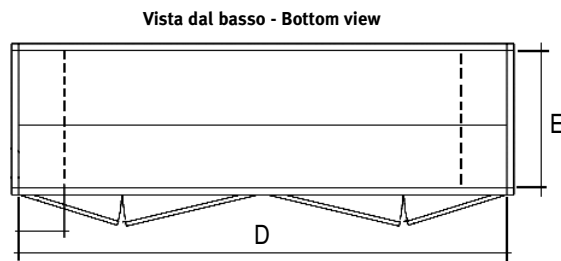
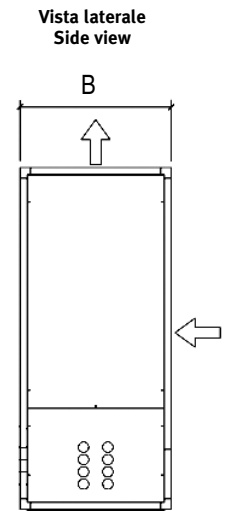
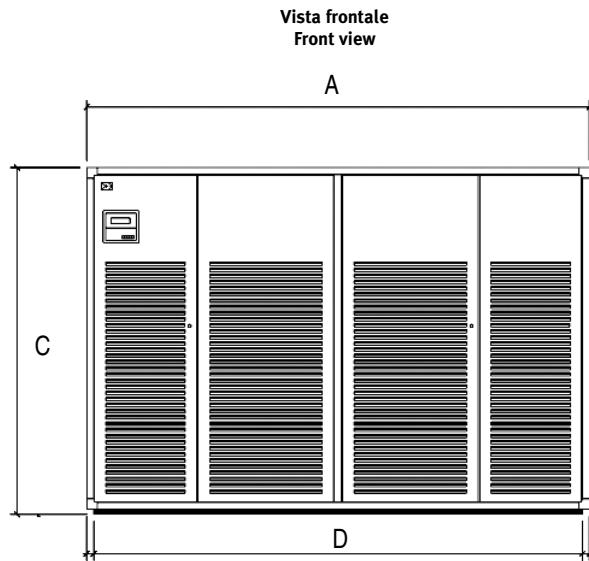

Layout
Frontale - Front

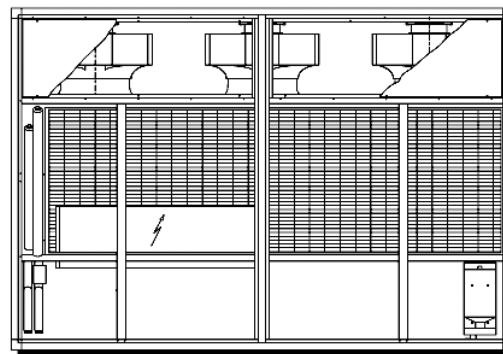

Layout
Laterale - Side

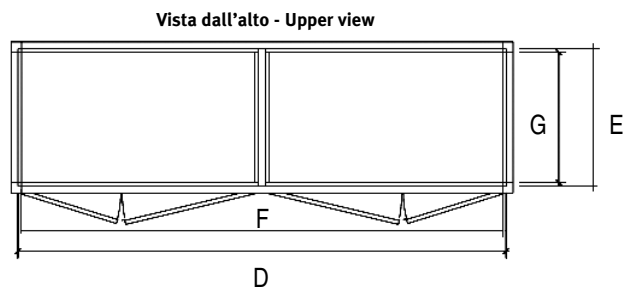
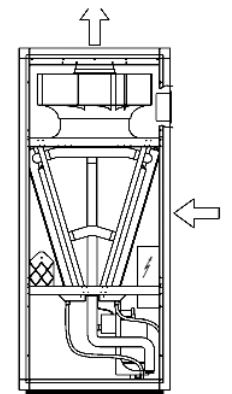

Please contact our Technical Dept. for detailed info about in/out position.