



*Airwell*

2022 • 2023 EUROPE CATALOG



FRENCH BRAND



## EDITO of Laurent Reegel CEO of Airwell

Optimizing our energy consumption, promoting solar energy to preserve our natural resources, reinventing consumer uses, cultivating home comfort... many are thinking about it. At Airwell, we are committed to this for the well-being of all and the environment.

Since 1947, when Airwell was created, we have demonstrated our ability to anticipate, innovate and offer solutions providing better thermal comfort for all of our customers. This is why we understood very early on that we had to rethink our relationship with Energy.

### Just feel well

Tomorrow's world must be built around a single principle: Serenity. Energy solutions must be simple, intuitive to manage and use, and totally reliable.

### Just feel green

They must provide a decrease in our energy consumption, to reduce the ecological and economic impact of our homes.

### Just feel smart

They must integrate artificial intelligence capable of creating energy optimization and preventive maintenance scenarios.

### With Airwell, the revolution is underway

A raising living standards for each consumer, and ensuring that all of our distributors and installers, like you, have the best tools to tackle the challenges of today and tomorrow.

And all this, is being done with you. As Airwell partners, you receive guaranteed support and training in a changing market, to be able to provide your customers with innovative and competitive solutions, tailored to their requirements and to our mission.



## Airwell CELEBRATING ITS 75<sup>th</sup> ANNIVERSARY and becomes a French group again

### GROUPE AIRWELL

Promising times in store for a historic brand created in 1947, and which has retained its DNA ever since:

**RELIABILITY • SERVICE • PARTNERSHIP • INNOVATION**



# Airwell

**MAKES YOUR LIFE EASIER**  
*with dedicated services*

## OUR ONLINE SERVICES

As an Airwell partner, you can sign into your **Airwell Pro account** from the [www.airwell-pro.com](http://www.airwell-pro.com) website and access multiple services.

Here you can look up our spare parts selection software and view the product exploded views as well as their references.

## TECHNICAL DOCUMENTATION



Discover and download all the technical documentation you need via our documentary library **accessible from our Pro site** or directly via this link:

<http://lh.airwell.com/>

## AFTER-SALES AND QUALITY SERVICE



**+33 (0)1 76 21 82 95**

*Monday to Friday  
9 am-12:30 pm / 2 pm-5 pm*

### ORDER SPARE PARTS

[sp@airwell.com](mailto:sp@airwell.com)

### TECHNICAL SUPPORT

[sav@airwell.com](mailto:sav@airwell.com)

**We want our customers to be satisfied with our services, which is why our teams constantly monitor our spare parts stock.**

Our interactive voice server (IVR) has been redesigned in order to provide more efficient and effective customer service. Our responsiveness and professionalism aim for a benchmark level of service.

## TECHNICAL SUPPORT AND PROJECTS

**Do you need technical assistance** in determining the right parts, electrical diagrams or even fault codes for you?

Our hotline, based in France, is ready to support you and help solving all your problems.

### CONTACT OUR EXPERTS



[presales@airwell.com](mailto:presales@airwell.com) • **+33 (0)1 76 21 82 82**

# TABLE OF CONTENTS

p.6	Our history
p.8	Airwell Academy
p.12	Service division

*Just feel smart*

## SMART RANGE

p.15	SMART HOME SOLUTIONS	
p.16		AirHome APP
p.18		Hybrid house
p.20		Hybrid solar solutions







*Just feel green*

## SOLAR RANGE





p.23	PHOTOVOLTAIC RANGE			
p.24		Solar panels		• Photovoltaic
p.26		Micro-inverters		• YC600, QS1, DS3-L & DS3
p.28		Pitched roof kits		• Fastening hooks and rails
p.30		Photovoltaic pack		• AirSolar offer







*Just feel well*

## RANGE AIR/WATER



p.33	HEAT PUMP AND DOMESTIC HOT WATER PRODUCTION RANGES				
p.34		WELLEA WT		R32	• Triple-service split heat pump
p.36		WELLEA Split		R32	• Split heat pump
p.38		WELLEA Monoblock		R32	• Monoblock heat pump
p.40		WELLEA Monoblock DF		R32	• Monoblock heat pump
p.42		TDF Eleo		R134A	• Thermodynamic water heater
p.44		Heating and DHW accessories			

## AIR/AIR RANGES

p.47	HIGH WALL RANGE				
p.48		HDMB Harmonia		R32	• High wall - Colour range
p.50		HDLA Aura		R32	• High wall
p.52		HDLE Aura		R32	• High wall - Built-in Wi-Fi <b>Available according to country</b>

p.55	CONSOLE, FLOOR CEILING & FLOOR STANDING RANGES				
p.56		XDLF		R32	• Dual-flow console <b>Available according to country</b>
p.58		FDMX		R32	• Floor ceiling
p.60		FDLK		R32	• Low-temperature floor ceiling
p.62		SDMX		R32	• Floor standing

**p.65 DUCTED RANGE**

<b>p.66</b>		DDMX		R32	• <i>Medium-pressure ducted</i>
<b>p.68</b>		WELLZONE			• <i>Zone-by-zone regulation</i>



**p.71 AIRFLOW RANGE**

<b>p.72</b>		JDAA Airflow		R32	• <i>Thermodynamic dual-flow CMV</i>
-------------	---	--------------	--	-----	--------------------------------------

**p.75 CASSETTE RANGE**

<b>p.76</b>		CDMX		R32	• <i>360° cassette</i>
-------------	---	------	---	-----	------------------------

**p.79 MULTISPLIT RANGE**

<b>p.80</b>		ZDAA		R32	• <i>Multisplit</i>
<b>p.88</b>		ZDAE			R32

**p.97 MONOBLOCK RANGE**

<b>p.98</b>		XDA		R32	• <i>Monoblock console</i>
<b>p.99</b>		WFAE		R32	• <i>Window</i>
<b>p.100</b>		MFH		R290	• <i>Portable - Cooling only</i>
<b>p.101</b>		MFR		R290	• <i>Portable - Reversible</i>

**p.103 WATER-COOLED RANGE**

<b>p.104</b>		XDOW		R410A	• <i>Water-cooled console</i>
<b>p.106</b>		DFMO		R410A	• <i>Water-loop heat pump</i>

**p.109 CONTROL SYSTEMS**

<b>p.110</b>		Compatibility tables			
<b>p.111</b>		Function tables			
<b>p.112</b>		Remote controls			

<b>p.126</b>	Installation accessories
<b>p.128</b>	Toolbox (installation assistance, recommendations...)
<b>p.144</b>	General terms and conditions of sale
<b>p.146</b>	Icon guide



**YOUR FRENCH  
EXPERT** *for the past 75 years*

## OUR HISTORY

**1947**

The beginning of the *Airwell* story.

**1950**

Airwell develops "Split" units by splitting the Window unit into 2 parts. This made it the first European manufacturer of this type of equipment.

**1970**

Development of "Split" units.

**1982**

Airwell, the 1<sup>st</sup> European manufacturer to produce wall units with built-in remote control, high-tech tangential turbines and quieter, more energy efficient rotary compressors.

**2013**

The company launches its unique and exclusive After-Sales Service, also including customer service.

**2014**

Creation of the *Airwell* ACADEMY, technical and qualification training for the installers' and maintenance engineers' network.

**2015**

Launch of the Renewable Energy project.

**2017**

Airwell celebrates its 70<sup>th</sup> anniversary and creates its France subsidiary



**2018**

- Development in the Middle East.
- Exclusive partnership in France 

**2020**

Launch of the AirConnect Smart and AirConnect Pro projects.



**2021**

### GROUPE **AIRWELL**

- Airwell becomes Airwell group following the takeover of Airwell Residential by Airwell Distribution.
- Launch of the new energy leasing offer.
- Launch of the Hybrid House offer.



## AND IN 2022?



Airwell will invest more heavily in the Research & Development so that the artificial intelligence (AI) and home automation technology is created and manufactured in France.

The objective of this innovation plan is to meet the needs of the end customer, with a comprehensive solution based on real-time and remote management of their energy equipment, and the energy consumption monitoring to manage their expenses.

On the professional side, new training centres will appear in France and elsewhere, with the aim of training sector professionals in the developments in the trade.

## ABOUT US

### A French brand regarded as the professional benchmark

A French expert and developer of HVAC solutions for the past 75 years, Airwell's mission has always been to create and cultivate well-being.

**A vision of the future.** Airwell was created in 1947 out of the crazy idea of bringing from United States innovative solutions that did not exist yet in Europe: air conditioning.

Today, **innovation is more crucial to Airwell than ever**, given our status as leaders in the creation of HVAC solutions. We apply a profoundly human approach to innovation, listening to our consumers, and like the family spirit that defines Airwell, is based on the common good, with due regard to everyone's expectations.

**Optimize our energetic consumption**, promoting solar energy to preserve our natural resources, reinventing consumer practices to limit our environmental footprint, cultivating home comfort... At Airwell, we are committed to these issues, for the well-being of all and for the environment.

*"What was just an ambition for us has become our mission."*



## OUR PRODUCTS

- Air/water range
- Air/air range
- Water-cooled range
- Tertiary and industrial range
- Solar range

## OUR CERTIFICATIONS

- **Airwell** participates in the ECP programme for AC1. Check ongoing validity of certificate: [www.eurovent-certification.com](http://www.eurovent-certification.com)



- Company compliant with standard **ISO 9001**



## IN FIGURES

- **1<sup>st</sup> european manufacturer** for air conditioning and heat pumps
- **More than 75 years** of experience
- Present in **80 countries**
- **more than 6500 references** in stock

## OUR COMMITMENTS

### Service is our priority

- Design of unique solutions
- Our DNA: partnership
- Help in making your projects a success
- Local and remote technical support

### French Quality and Expertise

- A historic French brand
- Innovative and competitive solutions
- Wide range of products to adapt to every need

## OUR VALUES AND CORPORATE CULTURE

### INNOVATION • SERENITY • COMFORT LISTENING • COMMITMENT

"Just feel well" sums up our corporate culture, based on lasting relationships for the common good, in which everyone is respected.

An extended family including employees, distributors, installers, maintenance technicians, partners and consumers.

*"A big family where everyone brings value to the business."*



# Airwell ACADEMY

## WHY AIRWELL ACADEMY?

### AIRWELL had to provide an solution!

- ▶ Technical & qualification training.
- ▶ Training tools: training rooms and training trolley rental service.
- ▶ Tailored services: residential and industrial energy audit.

*Airwell supports you in setting up an energy management system that is essential to your business and to the planet.*

Register for the training program at:  
[www.airwell-academy.fr](http://www.airwell-academy.fr)

## THE CENTRE

### THE TRAINING SPACE PROVIDES:

- An Airwell products showroom
- Several equipped training rooms
- An habilitation room
- A dining area and a kitchen
- An outdoor recreational area
- Private car park

## CONTACT US

### THE TRAINING CENTRE IN VALENCE, FRANCE:

#### Airwell Academy

66, rue Gilles de Roberval - 26000 VALENCE



[airwell-academy@airwell.com](mailto:airwell-academy@airwell.com)

**+33 (0)1 76 21 82 22**

or contact your Airwell sales representative





# TRAINING *Guide*

Airwell offers training services to develop your knowledge of products and the market environment.

RES01

**Technical training**  
**RESIDENTIAL**  
**APPLICATION**



DRV01

**Technical training**  
**VRF**  
**APPLICATION**



PAC01

**Technical training**  
**HEAT PUMP**  
**APPLICATION**



HA01

**Qualification training**  
**ELECTRICAL**  
**QUALIFICATION FOR**  
**AIR CONDITIONING**  
**BUSINESSES**



MET01

**Qualification training**  
**REFRIGERANT**  
**HANDLINGS**



FL01

**Qualification training**  
**CAT 1 APTITUDE**  
**CERTIFICATE - NON-**  
**EXPERIENCED**  
**TECHNICIAN**



FL02

**Qualification training**  
**CAT 1 APTITUDE**  
**CERTIFICATE -**  
**EXPERIENCED**  
**TECHNICIAN**



QUALIT ENR01

**Qualification training**  
**QUALIPAC**  
**HEAT PUMPS &**  
**DHW**

**RGE**  
RECONNU  
GARANT  
ENVIRONNEMENT



QUALIT ENR02

**Qualification training**  
**QUALIPV**  
**SOLAR**  
**PHOTOVOLTAIC**

**RGE**  
RECONNU  
GARANT  
ENVIRONNEMENT



QUALIT ENR03

**Qualification training**  
**QUALISOL CESI**  
**(CETIAT**  
**PARTNERSHIP)**

**RGE**  
RECONNU  
GARANT  
ENVIRONNEMENT



## NEED EQUIPMENT OR A TECHNICAL PLATFORM FOR YOUR TRAINING?

### TAILORED TROLLEYS

Our mission as climate engineering professionals is to support the trainees in the sector, and give them the means to upskill.

Climate engineering plays a major role in the training of the specialists and engineers.

This is why we have developed teaching equipment in the form of training trolleys, made in France, on which our products operate.

We offer a multitude of teaching equipment, tailored to Airwell products or custom-made.



### ROOM RENTAL

The Airwell Academy offers a rental service for its rooms, which are essential in teaching good practice in the refrigeration sectors.

**Quote and booking:**

[airwell-academy@airwell.com](mailto:airwell-academy@airwell.com)

**+33 (0)1 76 21 82 22**

[www.airwell-academy.fr](http://www.airwell-academy.fr)

## TRAINING ARRANGEMENT PROCEDURE

### YOUR TRAINING IN 4 STEPS

#### 1 ▶ REGISTER VIA:

- ▶ E-mail
- ▶ Telephone
- ▶ Internet

We then issue a quote to the customer

#### 2 ▶ REGISTRATION CONFIRMATION, THE FUTURE TRAINEE RECEIVES:

- ▶ The training agreement
- ▶ The invitation
- ▶ The program sheet
- ▶ The access map
- ▶ The internal rules

**Note: a copy of the signed agreement must be returned to us before the invitation.**

#### 3 ▶ TRAINING PERIOD

#### 4 ▶ AFTER THE TRAINING, THE TRAINEE RECEIVES

- ▶ The paid invoice
- ▶ The certificate of training completion
- ▶ The signed attendance sheet



## NEW!

*Take the time to take  
the virtual tour of  
our training centre  
in Valence, France!*

Scan the QR Code below:



# PRODUCT

## *new naming system*

See the table below to help you understand the new product naming system.



### ► UNDERSTANDING PRODUCT REFERENCES

TYPE	TECHNOLOGY	PRODUCT POSITIONING / IDU	UPGRADE	SIZE (kW)	MODE	REFRIGERANT	PHASE (current type)	POWER SUPPLY	ELECTRICAL FREQUENCY
B	DC Inverter	L Entry level	W 1 <sup>st</sup> upgrade	015 5000BTU / 1.5 kW	N Neutral	01 R410A	M Single-phase	1 110 V	5 50 Hz
C	Fix RPM	M Medium level	X 2 <sup>nd</sup> upgrade	022 7000BTU / 2.2 kW	T Triple-service	02 R407C	T Three-phase	2 220-230 V	6 60 Hz
D	VRF	H High-end	Y 3 <sup>rd</sup> upgrade	025 9000BTU / 2.5 kW	C Cooling only	03 R134A		3 380-400 V	2 50Hz/60Hz
F	Neutral	VEHICLE OF EXCHANGE / ODU	Z 4 <sup>th</sup> upgrade	035 12000BTU / 3.5 kW	R Reversible	04 R290		4 460 V	
H	A Air / Air		050 18000BTU / 5 kW	H Heating only	05 CO <sub>2</sub>				
J	H Air / Water		060 21000BTU / 6 kW	M Monocrystalline	06 R22				
M	W Water / Water		070 24000BTU / 7 kW	P Polycrystalline	07 R410a + R32				
O	O Water / Air		080 27000BTU / 8 kW		08 H <sub>2</sub> O				
P			090 30000BTU / 9 kW		09 R32				
R			100 36000BTU / 10 kW		10 Solar				
S			120 42000BTU / 12 kW						
T			140 48000BTU / 14 kW						
V			150 50000BTU / 15 kW						
W		160 55000BTU / 16 kW							
X		170 58000BTU / 17 kW							
Y		300 30 kW							
Z		...							



## BIM

*Airwell is "Bim Ready"!*

In partnership with , Airwell is implementing BIM (Building Information Modeling) and offering its range of tertiary and commercial air conditioning (VRF system) in BIM format distributed on the  library.

This allows REVIT® users to integrate Airwell content for all their building construction projects in the 3D numerical modelling world.

Airwell Academy offers training dedicated to BIM, including an introduction to the REVIT® functionalities, as well as to HVAC network design.

[www.mepcontent.com](http://www.mepcontent.com)



## GOLDEN FIN *technology*

- ▶ The **Golden Fin** treatment extends the device's service life by protecting the system against corrosion. Its innovative material improves heat transfer and slows the oxidation of key parts for long-term optimal performance.
- ▶ The anti-corrosion **gold-plated coating** on the condenser can withstand salty air, rain and other corrosive elements.
- ▶ In a 30-minute acid test, the golden fin showed no obvious corrosion marks, unlike the blue fin.

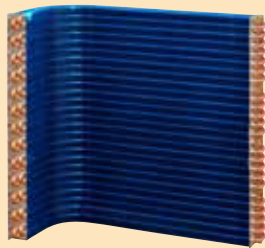

**Blue Fin**

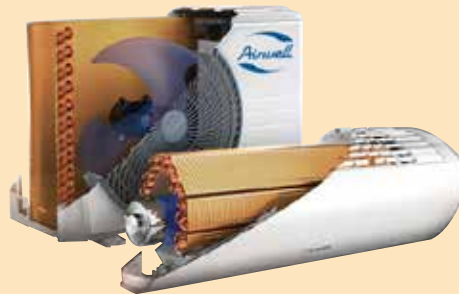

**Golden Fin**

- ▶ The golden fin has a smaller contact angle than the blue fin, which facilitates water flow and achieves better heat exchange efficiency and therefore a higher capacity.

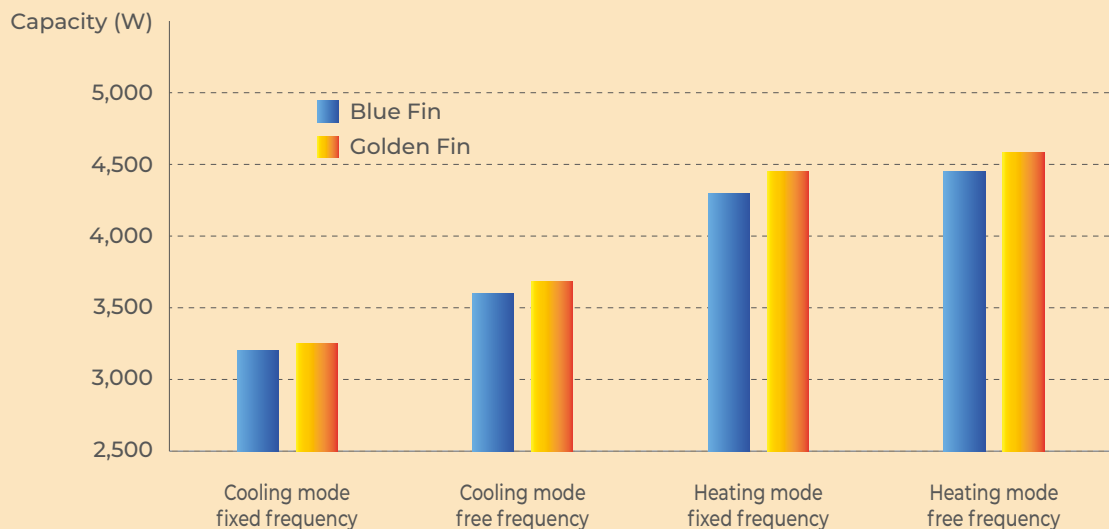



# SMART HOME SOLUTIONS

## MODEL

p.16

AIRHOME APP



p.18

HYBRID HOUSE



p.20

HYBRID SOLAR SOLUTIONS

Thanks to our free **AirHome**, app, available on Android and iOS, welcome to the Airwell hybrid and connected home!

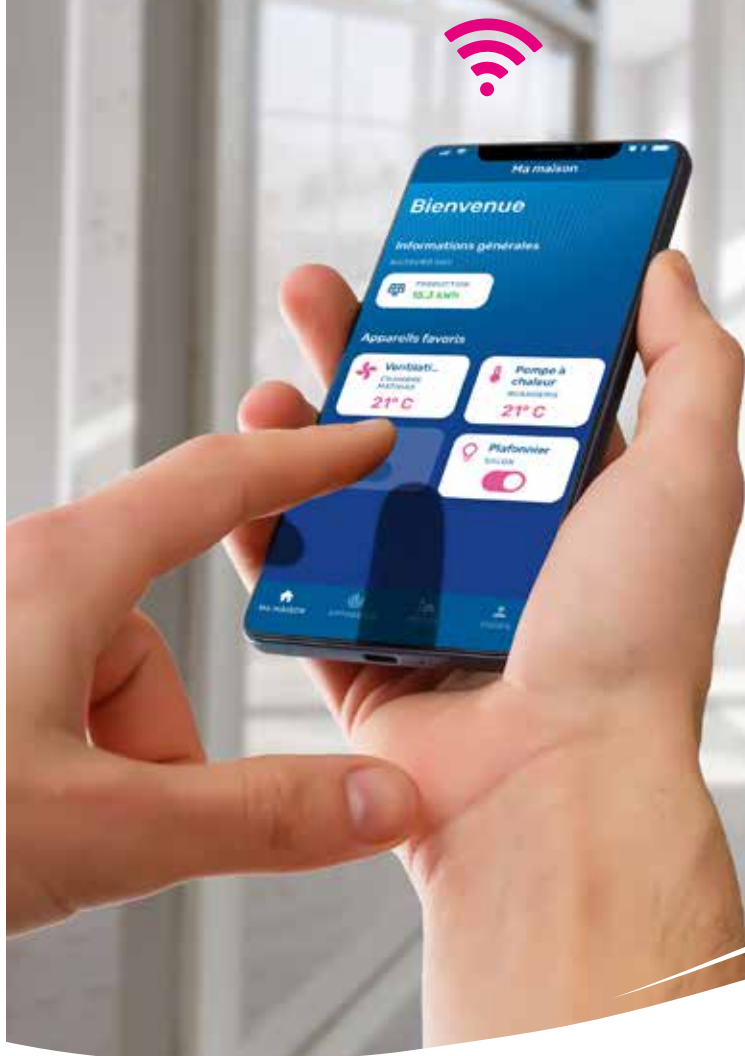

## CONTROL OF YOUR HOME

*at your fingertips*



### A single app to control your entire home!

Connecting to the AirHome app gives you optimal control of your HVAC equipment. An all-in-one app managing your air conditioning, heating, ventilation, domestic hot water and connected objects in the house, which makes your daily life easier (Plug&Play) while saving money.





### CONTROL YOUR HOME

Program all the appliances in the house, set the ideal temperature at different times of day according to your routine, manage different scenarios – all through AirHome to ensure total comfort while saving energy.



### CONTROL YOUR CONSUMPTION

Easily view the consumption of your devices according to your uses.



### CONNECTIVITY

Connect all your devices in a few clicks: your heat pump and other Airwell products, your compatible photovoltaic panels and other connected household equipment\*.



### SOLAR ENERGY PRODUCTION

View a snapshot of your solar electricity production at any time, as well as the history.



### ENERGY SAVING

Make big energy savings without having to think about it, our app's algorithm automatically optimizes the consumption of your devices by alternating solar and grid production.

\* Under development for 2022.

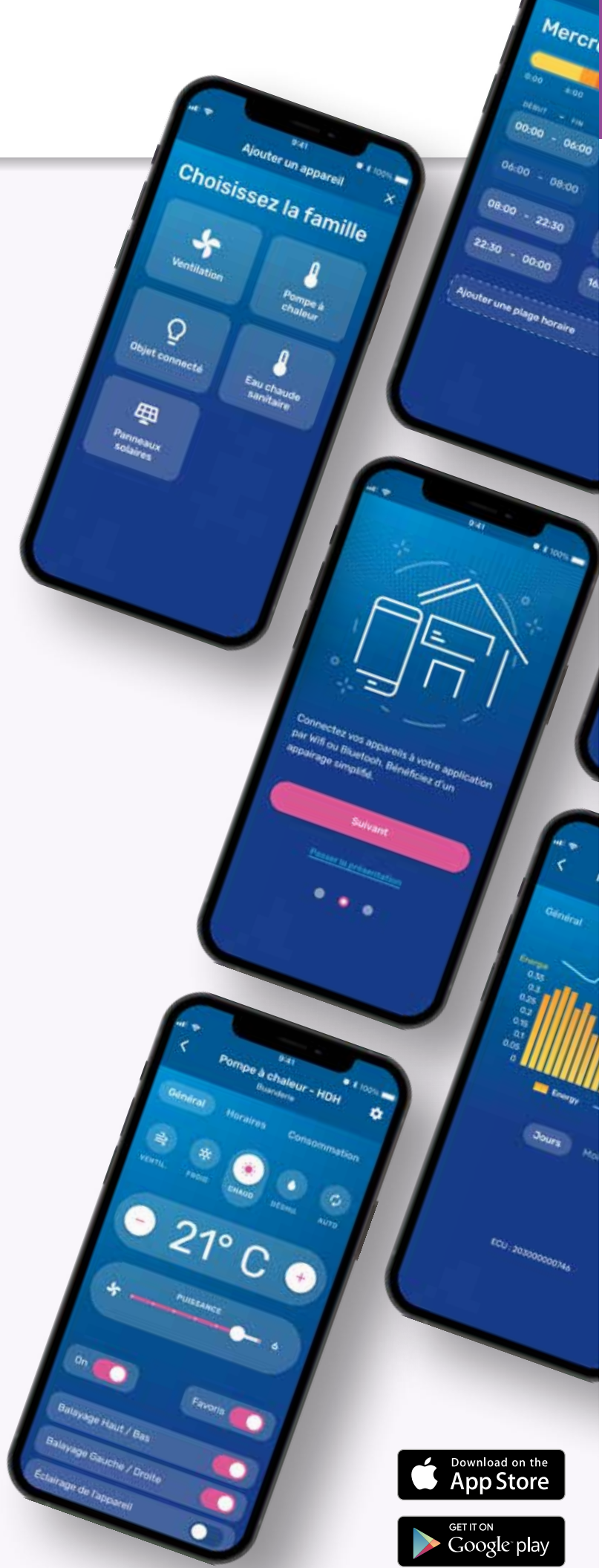

# HYBRID

## HOUSE by Airwell

Hybrid House by Airwell is the combination of the energy performance of heating products/heat pumps/air conditioning powered by photovoltaic energy; all controlled in an intelligent, connected and centralized system.

## GOING HYBRID *at your own pace!*

This is about creating the configuration that meets the customer's use and budget.

1

### YOU PRODUCE YOUR OWN ENERGY

With AirSolar photovoltaic solar panel kits and Dual Sun hybrid technology, you produce free energy (electricity and/or hot water) allowing you to make big savings. In addition, this energy allows you to minimize the carbon footprint (green energy).

**AirSolar**  
SOLUTIONS  **DUALSUN**

2

### YOU POWER ALL THE EQUIPMENT IN YOUR HOME

This energy produced makes your home more energy self-sufficient, as it is able to power the heating, air conditioning, ventilation, domestic hot water production and other equipment in your home\*.

3

### CONTROL OF YOUR EQUIPMENT AT YOUR FINGERTIPS



The AirHome app allows you to control your energy appliances from your smartphone and tablet. Hence, controlling your consumption has never been so easy!

\*under development in 2022.



**VISIT THE WEBSITE**  
Videos, explanation of the concept, approved installers network map.

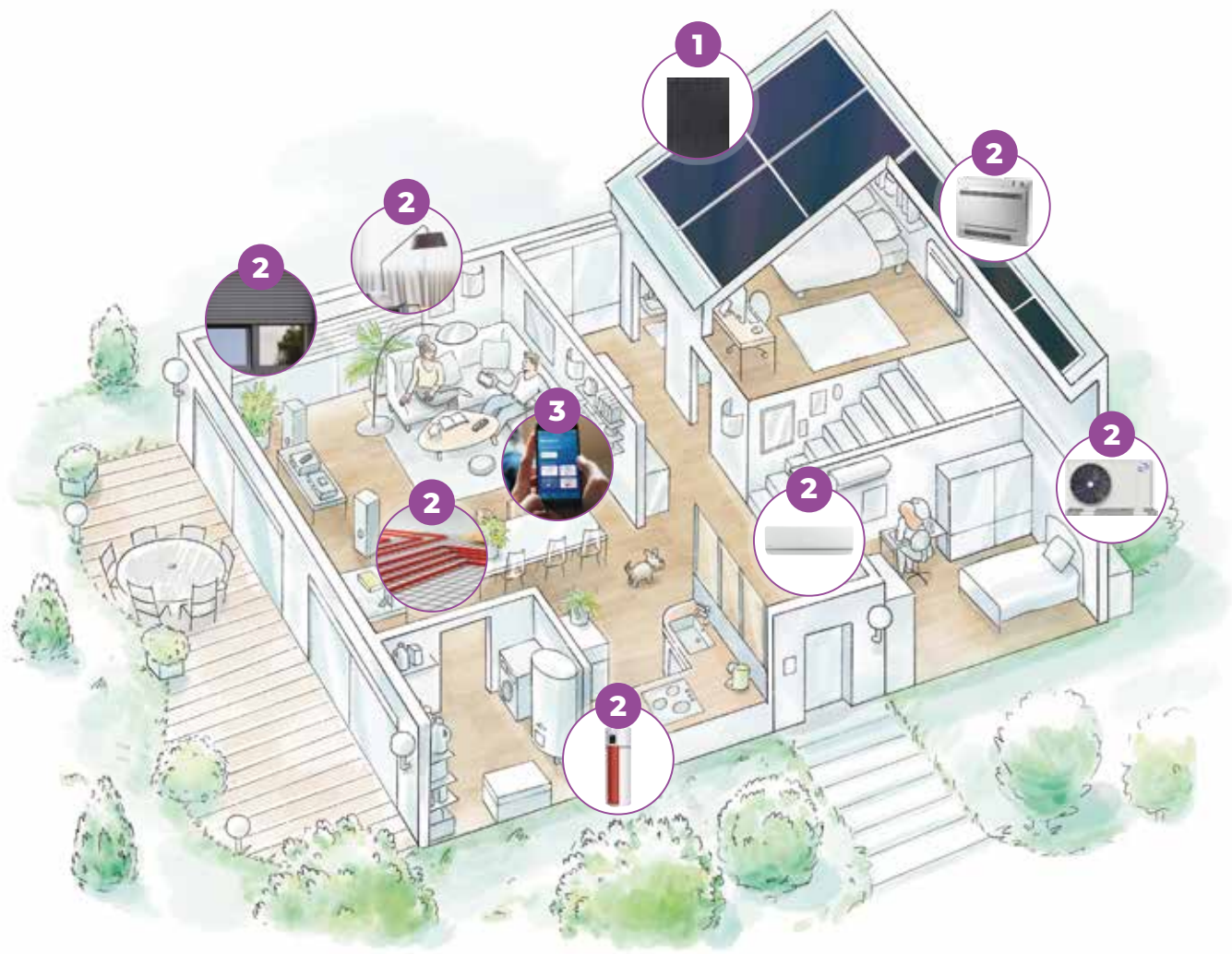

## ALL THE ENERGY *for your house*

DHW AND ELECTRICITY PRODUCTION



**WITH A TDF THERMODYNAMIC WATER HEATER**

### THIS SOLUTION ALLOWS YOU TO:

- ▶ Self-consume and sell the excess electricity that you produce
- ▶ Produce domestic hot water using several green energies
- ▶ Improve the energy efficiency of the installation
- ▶ Optimize the roof surface area
- ▶ Save even more

**Dual Sun hybrid panels (Flash et Spring) are compatible with our solar solutions.**

DUALSUN



Pictures non contractuels

## WITH A WELLEA HEAT PUMP

TO SET UP YOUR INSTALLATION, YOU WILL NEED TO FOLLOW THESE STEPS:

**1**▼  
 CHOOSE A WELLEA HEAT PUMP WITH ITS DOUBLE EXCHANGER HOT WATER TANK or THE SOLAR THERMODYNAMIC WATER HEATER

**2**▼  
 HYDRAULIC KIT

**3**▼  
 RAIL KIT

**4**▼  
 CHOOSE THE PITCHED ROOF KIT SUITABLE FOR YOUR HOUSE



# SOLAR

## Range

MODEL	PICTURE	DESIGNATION
<p>p.24</p> <p>SOLAR PANELS</p> 		<p>PHOTO-VOLTAIC</p>
<p>p.26</p> <p>MICRO-INVERTERS</p> 		<p>YC600, QS1, DS3-L &amp; DS3</p>
<p>p.28</p> <p>PITCHED ROOF KITS</p>		<p>FASTENING HOOKS AND RAILS</p>
<p>p.30</p> <p>PHOTOVOLTAIC PACK</p>	  	<p>SOLAR OFFER</p>

Solar

**HYBRID**  
HOUSE by Airwell

# SOLAR PANELS

**Air Solar**  
SOLUTIONS



## + PRODUCT AIR-S-330M

- High-performance monocrystalline cells
- Ideal for self-consumption
- Anti-reflective glass
- Design
- Compatible with all roof installation systems
- Reliable with low linear rated power drop after 20 years

## + PRODUCT PVMW

- High-performance monocrystalline cells
- Ideal for self-consumption
- Half cell for reduced resistive losses
- Full-black design
- Compatible with all roof installation systems
- Reliable with low linear rated power drop after 20 years

## QUALITY & SECURITY



IEC 61215 & IEC 61730  
STANDARD QUALITY



## WARRANTY



- **20 years warranty provided** you register your installation in our configurator, including the layout study carried out.
- **10 years product standard warranty.**



AIR-S-330M



PVMW-375M-FB  
PVMW-500M-FB





## TECHNICAL DATA

MODEL		While stocks last	NEW	
		AIR-S-330M	PVMW-375M-FB	PVMW-500M-FB
Part number		2EN200001	2EN230001	2EN230002

### PHOTOVOLTAIC CHARACTERISTICS (STC: 1000 W/M<sup>2</sup>, AM 1,5, 25°C)

Peak power (Pmpp)	Wc	330	375	500
Output power tolerance	%	3	3	3
PV module efficiency	%	19.78	20.5	21
Maximum power voltage (Vmpp)	V	34.17	34.5	38.43
Intensity at maximum power (Impp)	A	9.66	10.86	13.01
Open circuit voltage (Voc)	V	41.66	41.3	45.98
Short-circuit current (Isc)	A	10.04	11.79	13.87

### PHYSICAL CHARACTERISTICS

Length	mm	1665	1755	2100
Width	mm	1002	1038	1134
Thickness	mm	35	35	35
Weight	kg	19	21	25
Number of cells		60	120	132
Cell type		Monocrystalline Silicon PERC	Monocrystalline Silicon half cells	Monocrystalline Silicon half cells
Connectors		MC4 / MC4 compatible	MC4 / MC4 compatible	MC4 / MC4 compatible
Cable length	m	2 x 0.9	2 x 1.0	2 x 1.0
Junction box		IP68 - 3 diodes	IP68	IP68
Maximum load	Pa	5400 (snow) / 2400 (wind)	5400 (snow) / 2400 (wind)	5400 (snow) / 2400 (wind)
Frame / Backsheet		anodized aluminum black / black	anodized aluminum black / black	anodized aluminum black / black

### OPERATIONAL CHARACTERISTICS

Temperature	°C	-40° à +85°	-40° à +85°	-40° à +85°
Maximum system voltage	VDC	1000	1500	1500
NMOT	°C	45 ± 2	47 ± 2	47 ± 2

### TEMPERATURE COEFFICIENTS

Voltage temperature coefficient (Voc)	%/°C	-0.29	-0.40 (±0.05)	-0.40 (±0.05)
Current temperature coefficient (Isc)	%/°C	+0.08	+0.065 (±0.01)	+0.065 (±0.01)
Power temperature coefficient (Pmpp)	%/°C	-0.38	-0.5 (±0.05)	-0.5 (±0.05)



### + PRODUCT DS3-L & DS3

- Connection up to 2 PV modules
- Compact design
- 97% efficiency
- 2 MPPT for each module
- Maximum output power 730 and 880 VA
- Built-in VDE relays

### WARRANTY

PIECES  
WARRANTY  
**20** years

- **20 years warranty provided** you register your installation in our configurator, including the layout study carried out.
- **10 years product standard warranty.**





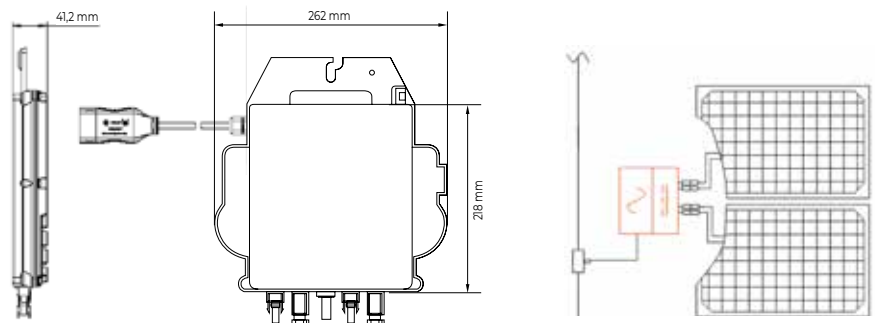

- > Better performance with 97% efficiency and unique integration with 20% fewer components.
- > DS3-L and DS3 are innovative grid-connected micro-inverters with power factor management features (RPC: Reactive Power Control).
- > They use the latest communication technologies, enabling intelligent management and monitoring of the installation by adjusting the power factor and thus meet the needs of energy suppliers by facilitating the integration of solar energy into the electricity grid.
- > They are compatible with the AirHome application, thanks to the ECU-R monitoring gateway, which makes it possible to:
  - view production in real time,
  - view production on a monthly and annual basis,
  - draw up scenarios based on instantaneous production.
- > Combining high reliability and high efficiency, the DS3-L and the DS3 have 2 independent MPPTs for an output power of 730 VA, 880 VA.
- > Real savings for residential and tertiary installations, both on equipment and installation costs.
- > The DS3-L and DS3 micro-inverters use the same AC cables and accessories, which means that they can be combined to provide great flexibility on the same installation.

### DS3-L & DS3 DIMENSIONS AND WIRING DIAGRAMS



### ACCESSORIES INCLUDED

#### IN THE RENEWABLE ENERGY KIT (see page 30)

ACCESSORY	PICTURE	FUNCTION/DESCRIPTION
AC Connection Tool		• Facilitates inverter disconnection from the AC cable.
Plug for AC cable connector		• Protects the connector not used by the AC cable.
AC termination plug		• Seals the ends of the AC cable.
Y3 AC BUS		• Provides a junction between the inverter AC output and the CSA/TUV certified grid connection. • 2.5 mm <sup>2</sup> , 3-branch cable (earth cable included).
DC cable extension		• DC cable extension to suit all roof configurations.
ECU-R (209018)		• Enables you to connect the system to the AirHome app and thus view production in real time.

## TECHNICAL DATA

Micro-inverters

Solar

		While stocks last		NEW	
MICRO-INVERTER		YC600	QS1	DS3-L	DS3
Part number		2EN220001	2EN220002	2EN250001	2EN250002

### INPUT DATA (DC)

MPPT Voltage Range	V	22-48		25-55	32-55
Operating voltage range	V	16-55		16-60	26-60
Maximum DC input voltage	V	60			
Maximum DC input current	A	12 x 2	12 x 4	18 x 2	20 x 2

### OUTPUT DATA (AC)

Maximum output power	VA	600	1200	730	880
Rated output voltage	V	230		230/184-253	
Rated output current	A	2.39	5.22	3.20	3.80
Maximum number of units per 20A branch	nb	7 /14 solar panels		6	5
Rated frequency range	Hz	50		50/48-51	
Power factor		0.8 advance... 0.8 delay (adjustable)		0.99/0.8 advance...0.8 delay (adjustable)	

### EFFICIENCY

Maximum efficiency	%	95.50	96.50	97.00	
CEC efficiency	%	-	-	96.50	
Rated MPPT efficiency	%	99.50		99.50	
Night-time electrical consumption	mW	20	30	20	

### PHYSICAL CHARACTERISTICS

Ambient operating temperature range	°C	-40 °C to +65 °C		-40 °C to +65 °C	
Internal operating temperature range	°C	-40 °C to +85 °C		-40 °C to +85 °C	
Dimensions (WxHxD)	mm	260x188x31.5	281x231x41.3	262 x 218 x 41.2	
Weight	kg	2.60	4.50	2.60	
AC cable section	mm <sup>2</sup>	-	-	2.5	
Connector type		MC4 or compatible		MC4	
Cooling system		Natural convection		Convection - No fan	
Protection index		IP67		IP67	

### CHARACTERISTICS AND COMPLIANCE

Protocol and communication		Zigbee encrypted			
Transformer type		High frequency transformer, galvanically isolated			
Monitoring		Access to monitoring options via AirHome APP			
Compliance, Security and EMS		EN 62109-1, EN 62109-2, EN61000-6-1, EN61000-6-2, EN61000-6-3, EN61000-6-4		EN 62109-1, EN 62109-2, EN61000-6-1, EN61000-6-2, EN61000-6-3	
Electrical network compliance		VDE0126-1-1/A1 VFR2014, RDF-NOI-RES_13E, EN 50438, VDE AR-N4105, RD 1699/2011, RD 413/2014, EN 50549	VDE4105, EN 50549-1, VDE126-1-1/A1 VFR2019, RD 1699/2011, RD 413/2014, UTEC15-712, ERDF-NOI-RES_13E	UNE217002, UNE206007, RD647, RD1699, RD413, CEI 0-21, VDE0126-1-1, VFR2019, UTE C15-712-1, ERDF-NOI-RES_13E, EN 50549, VDE AR-N4105	

# PITCHED ROOF KITS

## Fastening hooks and rails

### FEATURES



FLEMISH TILES/CHANNEL



FLAT SCALE TILES



STALES



TRAPEZOIDAL SHEET



TRAPEZOIDAL SANDWICH SHEET



CORRUGATED SHEET



FIBRE-CEMENT



STANDING SEAM

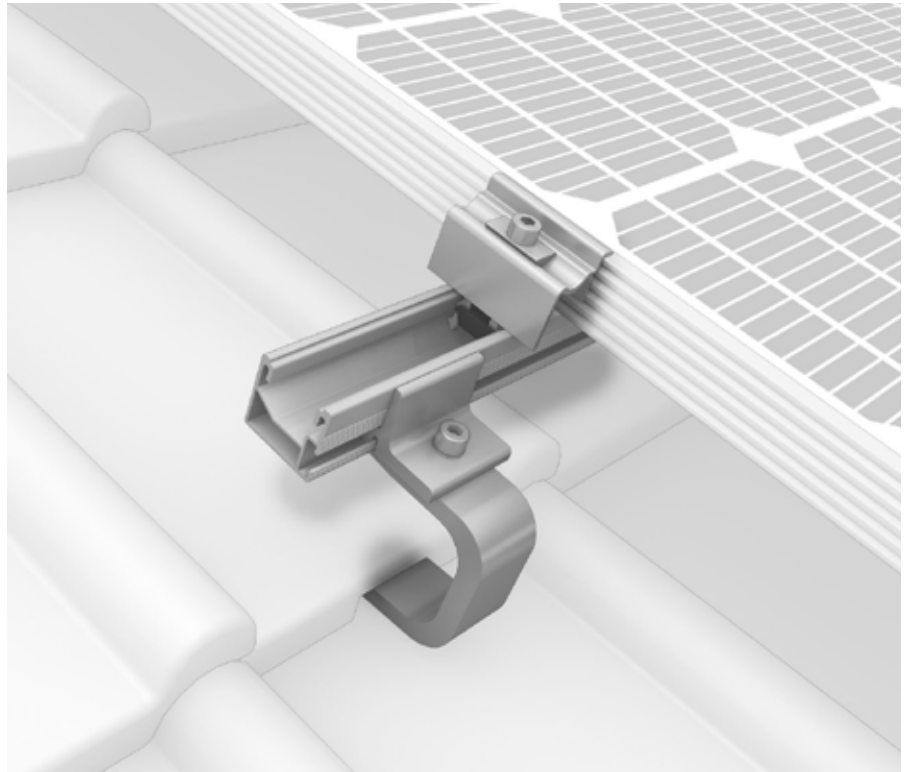

### WARRANTY



- **20 years warranty provided** you register your installation in our configurator, including the layout study carried out.
- **10 years product standard warranty.**



## ROOF HOOKS FOR SINGLE RAIL

Pitched roof kit

Solar

TYPE	PICTURE		MATERIAL	BASE PLATE WIDTH (L)	HEIGHT UNDER ARMS (H1) ARM HEIGHT (H2) TOTAL HEIGHT (H3)	DEPTH (P)
CROSSHOOK 4S			Aluminium	100 mm	<ul style="list-style-type: none"> <li>• 40/47/54 mm</li> <li>• 55 - 85 mm</li> <li>• 120.5 -165 mm</li> </ul>	83 mm

For Flemish tile  
Lateral and height adjustment on the base plate and stepless adjustment of the arm opening  
Can also be used on narrow rafters

## FASTENING KITS

NAME	DESCRIPTION	PICTURE
ONE MID	Universal intermediate caliper kit, 32-42mm, black anodized	
ONE END	Universal final caliper kit, 32-42mm, black anodized	
SINGLE RAIL	Fastening rail kit (2.10 / 3.25) x39.4x36 (LxWxH) mm	
RAIL CONNECTOR	Single Rail connector kit to connect 2 rails	
END CAP	Protective cap for rail finish	
SCREWS	8x80 self-drilling wood screw kit	

Contact us for any dimensioning  
outside the catalogue

# PHOTOVOLTAIC PACK

## AirSolar AIR-S-330M Offer

BUILD YOUR KIT **ACCORDING TO YOUR NEEDS!**

FOLLOW THE DIFFERENT STEPS TO BUILD YOUR KIT

1▼

Choose the desired power for your photovoltaic installation

2▼

Choose the fastening rails

3▼

Choose the add-on equipment suited to your needs (roof type, mounting type)

### 1► DESIRED POWER

#### KIT COMPOSITION 1.65 kWp

KIT PART NUMBER: 2EN210002		
Kit composition	Part number	Quantity
Solar panel AIR S 330 Wp	2EN200001	5
QSI 4 output mono micro-inverter	2EN220002	1
YC600 2 output mono micro-inverter	2EN220001	1
Monitoring gateway	209018	1
Wiring kit	2ACEL0001	1
Single-phase AC 0.6/6 kW electrical box	2ACEL0002	1

#### KIT COMPOSITION 2.97 kWp

KIT PART NUMBER: 2EN210003		
Kit composition	Part number	Quantity
Solar panel AIR S 330 Wp	2EN200001	9
QSI 4 output mono micro-inverter	2EN220002	2
YC600 2 output mono micro-inverter	2EN220001	1
Monitoring gateway	209018	1
Wiring kit	2ACEL0001	1
Single-phase AC 0.6/6 kW electrical box	2ACEL0002	1

### 2► DESIRED FASTENING RAILS

#### PORTRAIT RAIL KIT COMPOSITION 1.65 kWp

Kit composition	Part number	Quantity
Single Rail 36, length 3.30 m	2003239	4

#### PORTRAIT RAIL KIT COMPOSITION 2.97 kWp

Kit composition	Part number	Quantity
Single Rail 36, length 3.30 m	2003239	6

#### LANDSCAPE RAIL KIT COMPOSITION 2.97 kWp

Kit composition	Part number	Quantity
Single Rail 36, length 2.10 m	2001865	6
Single Rail 36, length 3.30 m	2003239	6

### 3► DESIRED OVERLAY EQUIPMENT

#### PORTRAIT OVERLAY TILES 1.65 kWp (1X5)

Full designation	Part number: 2ACTL0002
Hooks, screws, bracket, overlay kit required for fastening the modules	

#### PORTRAIT OVERLAY TILES 2.97 kWp (3X3)

Full designation	Part number: 2ACTL0003
Hooks, screws, bracket, overlay kit required for fastening the modules	

#### PORTRAIT OVERLAY STALES 1.65 kWp (1X5)

Full designation	Part number: 2ACTL0010
Hooks, screws, bracket, overlay kit required for fastening the modules	

#### PORTRAIT OVERLAY STALES 2.97 kWp (3X3)

Full designation	Part number: 2ACTL0011
Hooks, screws, bracket, overlay kit required for fastening the modules	

#### LANDSCAPE OVERLAY TILES 2.97 kWp (3X3)

Full designation	Part number: 2ACTL0006
Hooks, screws, bracket, overlay kit required for fastening the modules	

#### LANDSCAPE OVERLAY STALES 2.97 kWp (3X3)

Full designation	Part number: 2ACTL0014
Hooks, screws, bracket, overlay kit required for fastening the modules	

## KIT COMPOSITION 4.62 kWp

KIT PART NUMBER: 2EN210004		
Kit composition	Part number	Quantity
Solar panel AIR S 330 Wp	2EN200001	14
QSI 4 output mono micro-inverter	2EN220002	3
YC600 2 output mono micro-inverter	2EN220001	1
Monitoring gateway	209018	1
Wiring kit	2ACEL0003	1
Single-phase AC 0.6/6 kW electrical box	2ACEL0002	1



## KIT COMPOSITION 5.94 kWp

KIT PART NUMBER: 2EN210005		
Kit composition	Part number	Quantity
Solar panel AIR S 330 Wp	2EN200001	18
QSI 4 output mono micro-inverter	2EN220002	4
YC600 2 output mono micro-inverter	2EN220001	1
Monitoring gateway	209018	1
Wiring kit	2ACEL0004	1
Single-phase AC 0.6/6 kW electrical box	2ACEL0002	1



## PORTRAIT RAIL KIT COMPOSITION 4.62 kWp

Kit composition	Part number	Quantity
Single Rail 36, length 2.10 m	2001865	4
Single Rail 36, length 3.30 m	2003239	8

OU

## LANDSCAPE RAIL KIT COMPOSITION 4.62 kWp

Kit composition	Part number	Quantity
Single Rail 36, length 2.10 m	2001865	4
Single Rail 36, length 3.30 m	2003239	12



## PORTRAIT RAIL KIT COMPOSITION 5.94 kWp

Kit composition	Part number	Quantity
Single Rail 36, length 3.30 m	2003239	12

OU

## LANDSCAPE RAIL KIT COMPOSITION 5.94 kWp

Kit composition	Part number	Quantity
Single Rail 36, length 2.10 m	2001865	4
Single Rail 36, length 3.30 m	2003239	16



## PORTRAIT OVERLAY TILES 4.62 kWp (7X2)

Full designation	Part number: 2ACTL0004
Hooks, screws, bracket, overlay kit required for fastening the modules	

OU

## PORTRAIT OVERLAY STALES 4.62 kWp (7X2)

Full designation	Part number: 2ACTL0012
Hooks, screws, bracket, overlay kit required for fastening the modules	

OU

## LANDSCAPE OVERLAY TILES 4.62 kWp (7X2)

Full designation	Part number: 2ACTL0007
Hooks, screws, bracket, overlay kit required for fastening the modules	

OU

## LANDSCAPE OVERLAY STALES 4.62 kWp (7X2)

Full designation	Part number: 2ACTL0015
Hooks, screws, bracket, overlay kit required for fastening the modules	

## PORTRAIT OVERLAY TILES 5.94 kWp (9X2)

Full designation	Part number: 2ACTL0005
Hooks, screws, bracket, overlay kit required for fastening the modules	

OU

## PORTRAIT OVERLAY STALES 5.94 kWp (9X2)

Full designation	Part number: 2ACTL0013
Hooks, screws, bracket, overlay kit required for fastening the modules	

OU

## LANDSCAPE OVERLAY TILES 5.94 kWp (9X2)

Full designation	Part number: 2ACTL0008
Hooks, screws, bracket, overlay kit required for fastening the modules	

OU

## LANDSCAPE OVERLAY STALES 5.94 kWp (9X2)

Full designation	Part number: 2ACTL0016
Hooks, screws, bracket, overlay kit required for fastening the modules	





# HEAT PUMPS & DOMESTIC HOT WATER PRODUCTION

## Ranges

	MODEL	REFERENCE	REFRIGERANT TYPE	Preferred application	Mode	Domestic hot water
p.34		WELLEA WT 	R32	New-build	Cooling and heating	Built-in
	TRIPLE-SERVICE SPLIT HEAT PUMP					
p.36		WELLEA Split	R32	New-build	Cooling and heating	Optional
	SPLIT HEAT PUMP					
p.38		WELLEA Monoblock	R32	Refur-bishment	Cooling and heating	Optional
	MONOBLOCK HEAT PUMP					
p.40		WELLEA Monoblock DF	R32	Refur-bishment	Cooling and heating	Optional
	MONOBLOCK HEAT PUMP					
p.42		TDF Eleo	R134A	-	-	Built-in
	THERMODYNAMIC WATER HEATER					
p.44	Heating and DHW accessories					



Triple-service  
heat pump

A+++

**HYBRID**  
HOUSE by Airwell



+ PRODUCT

- RCW29 remote control included
- Refrigerant connections, no need for antifreeze protection
- Water outlet up to 60°C at outdoor temperature -15°C
- Compatible with all transmitter types
- Stainless steel hot water tank included (190L or 250L)

FEATURES



# WELLEA WT

Split heat pump  
with DHW tank included

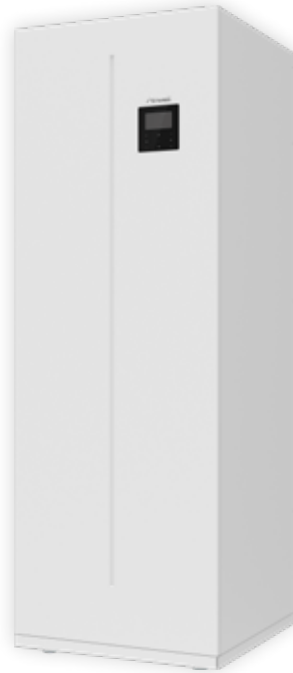

WELLEA WT  
with DHW tank included



RCW29  
included



WELLEA  
ODU 4-6 kW



WELLEA  
ODU 8-16 kW



+ «SUSTAINABLE DEVELOPMENT»

- > High energy class A+++.

+ «USER»

- > Compatible with all transmitters.
- > Great flexibility of use.
- > Perfect for replacing an oil or gas boiler.
- > Stainless steel hot water tank.

+ «INSTALLER»

- > Customizable water program.
- > Manage the entire heating circuit, thanks to the many available connections.

+ «TECHNOLOGY»

- > Operates at outdoor temperatures down to -25°C.
- > HP Keymark certified.

*Complete unit*  
**FOR HEATING AND HOT WATER**



## TECHNICAL DATA

OUTDOOR UNITS			AW-YHPSA04-H91	AW-YHPSA06-H91	AW-YHPSA08-H91	AW-YHPSA10-H91	AW-YHPSA12-H91	AW-YHPSA14-H91	AW-YHPSA16-H91	AW-YHPSA12-H93	AW-YHPSA14-H93	AW-YHPSA16-H93
Part number			7HP061065	7HP061066	7HP061067	7HP061068	7HP061069	7HP061070	7HP061071	7HP061072	7HP061073	7HP061074
Phase			Single-phase	Single-phase	Single-phase	Single-phase	Single-phase			Three-phase		
<b>HEATING MODE</b>												
Air +7°C Water 30/35°C	Heating capacity	kW	4.25	6.20	8.30	10.00	12.10	14.50	16.00	12.10	14.50	16.00
	Power input	kW	0.82	1.24	1.60	2.00	2.44	3.09	3.56	2.44	3.09	3.56
	<b>COP</b>		<b>5.20</b>	<b>5.00</b>	<b>5.20</b>	<b>5.00</b>	<b>4.95</b>	<b>4.70</b>	<b>4.50</b>	<b>4.95</b>	<b>4.70</b>	<b>4.50</b>
Air -7°C Water 30/35°C	Heating capacity	kW	4.80	6.10	7.10	8.25	10.00	12.00	13.30	10.00	12.00	13.30
	Power input	kW	1.52	2.00	2.18	2.62	3.33	4.29	4.93	3.33	4.29	4.93
	<b>COP</b>		<b>3.15</b>	<b>3.05</b>	<b>3.25</b>	<b>3.15</b>	<b>3.00</b>	<b>2.80</b>	<b>2.70</b>	<b>3.00</b>	<b>2.80</b>	<b>2.70</b>
Air +7°C Water 47/55°C	Heating capacity	kW	4.40	6.00	7.50	9.50	12.00	13.80	16.00	12.00	13.80	16.00
	Power input	kW	1.49	2.00	2.36	3.06	3.87	4.60	5.52	3.87	4.60	5.52
	<b>COP</b>		<b>2.95</b>	<b>3.00</b>	<b>3.18</b>	<b>3.10</b>	<b>3.10</b>	<b>3.00</b>	<b>2.90</b>	<b>3.10</b>	<b>3.00</b>	<b>2.90</b>
Air -7°C Water 47/55°C	Heating capacity	kW	4.00	5.15	6.15	7.05	10.60	11.30	12.60	10.60	11.30	12.60
	Power input	kW	2.05	2.58	3.00	3.53	5.25	5.46	6.29	5.25	5.46	6.29
	<b>COP</b>		<b>1.95</b>	<b>2.00</b>	<b>2.05</b>	<b>1.97</b>	<b>2.02</b>	<b>2.01</b>	<b>2.00</b>	<b>2.02</b>	<b>2.01</b>	<b>2.00</b>
<b>COOLING MODE</b>												
Air 35°C Water 12/7°C	Cooling capacity	kW	4.70	7.00	7.40	8.20	11.60	12.70	14.00	11.60	12.70	14.00
	Power input	kW	1.36	2.33	2.19	2.48	4.22	4.98	5.71	4.22	4.98	5.71
	<b>EER</b>		<b>3.45</b>	<b>3.00</b>	<b>3.38</b>	<b>3.30</b>	<b>2.75</b>	<b>2.55</b>	<b>2.45</b>	<b>2.75</b>	<b>2.55</b>	<b>2.45</b>
Air 35°C Water 23/18°C	Cooling capacity	kW	4.50	6.55	8.40	10.00	12.00	13.50	14.90	12.00	13.50	14.90
	Power input	kW	0.81	1.34	1.66	2.08	3.00	3.75	4.38	3.00	3.75	4.38
	<b>EER</b>		<b>5.55</b>	<b>4.90</b>	<b>5.05</b>	<b>4.80</b>	<b>4.00</b>	<b>3.60</b>	<b>3.40</b>	<b>4.00</b>	<b>3.60</b>	<b>3.40</b>
<b>PERFORMANCE</b>												
Energy label (Average climate)	Water outlet to 35°C		A+++				A+++					
	Water outlet to 55°C		A++				A++					
Seasonal efficiency (Average climate)	Water outlet to 35°C	%	191	195	205	205	189	186	182	189	186	182
	Water outlet to 55°C	%	130	138	132	137	135	136	133	135	136	133
SCOP (Average climate)	Water outlet to 35°C		4.85	4.95	5.21	5.19	4.81	4.72	4.62	4.81	4.72	4.62
	Water outlet to 55°C		3.31	3.52	3.36	3.49	3.45	3.47	3.41	3.45	3.47	3.41
Sound level		dB(A)	56	58	59	60	64	65	68	64	65	68
Sound pressure level (1m)		dB(A)	44	45	46	49	50	51	55	50	51	55
<b>OPERATING LIMITS</b>												
Outdoor temperature	Cooling	°C	-5/43				-5/43					
	Heating	°C	-25/35				-25/35					
	DHW	°C	-25/43				-25/43					
<b>POWER SUPPLY</b>												
Phase/Voltage/Frequency		1P/220-240V/50Hz					1P/220-240V/50Hz			3P/380-415V/50Hz		
Max. current	A	14			17		25	26	27	10	11	12
<b>INSTALLATION &amp; OTHERS</b>												
Airflow	m³/h	2770			4030		4060	4650		4060		4650
<b>Refrigerant/GWP</b>		<b>R32/675</b>										
Charge	kg	1.50			1.65		1.84					
Additional charge	g/m	20			38		38					
Unit dimensions (WxHxD)	mm	1008x712x426			1118x865x523		1118x865x523					
Package dimensions (WxHxD)	mm	1065x800x485			1180x890x560		1180x890x560					
Net weight/Gross weight	kg	58/64			77/88		96/110			112/125		
Pipe diameter (liquid - gas)	inches	1/4" - 5/8"			3/8" - 5/8"		3/8" - 5/8"			3/8" - 5/8"		

INDOOR UNITS			ODMA-100T-09M22-19				ODMA-100T-09M22-25				ODMA-160T-09M22-25						
Part number			7SPI30001				7SPI30002				7SPI30003						
COMPATIBLE OUTDOOR UNITS			AW-YHPSA04-H91	AW-YHPSA06-H91	AW-YHPSA08-H91	AW-YHPSA10-H91	AW-YHPSA04-H91	AW-YHPSA06-H91	AW-YHPSA08-H91	AW-YHPSA10-H91	AW-YHPSA12-H91	AW-YHPSA14-H91	AW-YHPSA16-H91	AW-YHPSA12-H93	AW-YHPSA14-H93	AW-YHPSA16-H93	
Phase			Single-phase				Single-phase				Single-phase						
<b>TANK</b>																	
Volume	l	190				240				240							
Electrical resistor	kW	3				3				3							
<b>PERFORMANCE</b>																	
DHW profile		L				XL				XL							
DHW energy label (average climate)		A+				A+				A+							
DHW seasonal efficiency (average climate)	%	127				136				123							
DHW COP		3.10				3.34				3.00							
Sound level	dB(A)	42				42				43							
Sound pressure level (1m)	dB(A)	30				30				32							
<b>POWER SUPPLY</b>																	
Phase/Voltage/Frequency		1P/220-240V/50Hz								1P/220-240V/50Hz							
Max. current	A	14.30								14.30							
<b>INSTALLATION &amp; OTHERS</b>																	
Water pipe diameter	inches	R1								R1							
DHW pipe diameter	inches	R3/4								R3/4							
Unit dimensions (WxHxD)	mm	600x600x1683				600x600x1943				600x600x1943							
Package dimensions (WxHxD)	mm	653x653x1900				653x653x2160				653x653x2160							
Net weight/Gross weight	kg	140/161				157/178				159/180							

Wellea WT

Air/Water-cooled  
heat pump &  
DHW



Reversible  
heat pump

A+++

**HYBRID**  
HOUSE by Airwell



### + PRODUCT

- Refrigerant connections, no need for antifreeze protection
- Water outlet up to 60°C at outdoor temperature -15°C
- Compatible with all transmitter types
- Electrical resistor included

### FEATURES

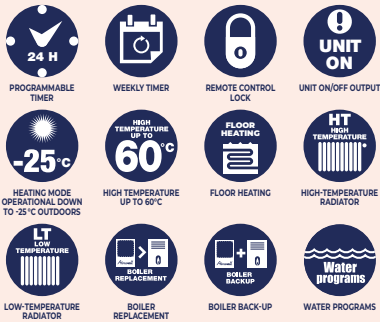

# WELLEA SPLIT

## Split heat pump



WELLEA SPLIT  
indoor unit



WELLEA  
ODU 4-6 kW



WELLEA  
ODU 8-16kW



### + «SUSTAINABLE DEVELOPMENT»

- > High energy class A+++.

### + «USER»

- > Compatible with all transmitters.
- > Great flexibility of use.
- > Perfect for replacing an oil or gas boiler.

### + «INSTALLER»

- > Customizable water program.
- > Manage the entire heating circuit, thanks to the many available connections.

### + «TECHNOLOGY»

- > Operates at outdoor temperatures down to -25°C.
- > HP Keymark certified.

### SOUND PRESSURE



WELLEA SPLIT		4 KW	6 KW	8 KW	10 KW	12 KW	14 KW	16 KW
Sound pressure level* at 5 m	dB(A)	30	32	34	35	37	38	42
Sound pressure level* at 10 m	dB(A)	15	17	19	20	22	23	27

\*Free field

## TECHNICAL DATA

Wellea Split

Air/Water-cooled  
heat pump &  
DHW

OUTDOOR UNIT			AW-YHPSA04-H91	AW-YHPSA06-H91	AW-YHPSA08-H91	AW-YHPSA10-H91	AW-YHPSA12-H91	AW-YHPSA14-H91	AW-YHPSA16-H91	AW-YHPSA12-H93	AW-YHPSA14-H93	AW-YHPSA16-H93
<b>Part number</b>			<b>7HP061065</b>	<b>7HP061066</b>	<b>7HP061067</b>	<b>7HP061068</b>	<b>7HP061069</b>	<b>7HP061070</b>	<b>7HP061071</b>	<b>7HP061072</b>	<b>7HP061073</b>	<b>7HP061074</b>
<b>Phase</b>			Single-phase				Single-phase			Three-phase		
<b>HEATING MODE</b>												
Air +7°C Water 30/35°C	Heating capacity	kW	4.25	6.20	8.30	10.00	12.10	14.50	16.00	12.10	14.50	16.00
	Power input	kW	0.82	1.24	1.60	2.00	2.44	3.09	3.56	2.44	3.09	3.56
	<b>COP</b>		<b>5.20</b>	<b>5.00</b>	<b>5.20</b>	<b>5.00</b>	<b>4.95</b>	<b>4.70</b>	<b>4.50</b>	<b>4.95</b>	<b>4.70</b>	<b>4.50</b>
Air -7°C Water 30/35°C	Heating capacity	kW	4.80	6.10	7.10	8.25	10.00	12.00	13.30	10.00	12.00	13.30
	Power input	kW	1.52	2.00	2.18	2.62	3.33	4.29	4.93	3.33	4.29	4.93
	<b>COP</b>		<b>3.15</b>	<b>3.05</b>	<b>3.25</b>	<b>3.15</b>	<b>3.00</b>	<b>2.80</b>	<b>2.70</b>	<b>3.00</b>	<b>2.80</b>	<b>2.70</b>
Air +7°C Water 47/55°C	Heating capacity	kW	4.40	6.00	7.50	9.50	12.00	13.80	16.00	12.00	13.80	16.00
	Power input	kW	1.49	2.00	2.36	3.06	3.87	4.60	5.52	3.87	4.60	5.52
	<b>COP</b>		<b>2.95</b>	<b>3.00</b>	<b>3.18</b>	<b>3.10</b>	<b>3.10</b>	<b>3.00</b>	<b>2.90</b>	<b>3.10</b>	<b>3.00</b>	<b>2.90</b>
Air -7°C Water 47/55°C	Heating capacity	kW	4.00	5.15	6.15	7.05	10.60	11.30	12.60	10.60	11.30	12.60
	Power input	kW	2.05	2.58	3.00	3.53	5.25	5.46	6.29	5.25	5.46	6.29
	<b>COP</b>		<b>1.95</b>	<b>2.00</b>	<b>2.05</b>	<b>1.97</b>	<b>2.02</b>	<b>2.01</b>	<b>2.00</b>	<b>2.02</b>	<b>2.01</b>	<b>2.00</b>

<b>COOLING MODE</b>												
Air 35°C Water 12/7°C	Cooling capacity	kW	4.70	7.00	7.40	8.20	11.60	12.70	14.00	11.60	12.70	14.00
	Power input	kW	1.36	2.33	2.19	2.48	4.22	4.98	5.71	4.22	4.98	5.71
	<b>EER</b>		<b>3.45</b>	<b>3.00</b>	<b>3.38</b>	<b>3.30</b>	<b>2.75</b>	<b>2.55</b>	<b>2.45</b>	<b>2.75</b>	<b>2.55</b>	<b>2.45</b>
Air 35°C Water 23/18°C	Cooling capacity	kW	4.50	6.55	8.40	10.00	12.00	13.50	14.90	12.00	13.50	14.90
	Power input	kW	0.81	1.34	1.66	2.08	3.00	3.75	4.38	3.00	3.75	4.38
	<b>EER</b>		<b>5.55</b>	<b>4.90</b>	<b>5.05</b>	<b>4.80</b>	<b>4.00</b>	<b>3.60</b>	<b>3.40</b>	<b>4.00</b>	<b>3.60</b>	<b>3.40</b>

<b>PERFORMANCE</b>												
Energy label (average climate)	Water outlet to 35°C		A+++				A+++					
	Water outlet to 55°C		A++				A++					
Seasonal efficiency (average climate)	Water outlet to 35°C	%	191	195	205	205	189	186	182	189	186	182
	Water outlet to 55°C	%	130	138	132	137	135	136	133	135	136	133
SCOP (average climate)	Water outlet to 35°C		4.85	4.95	5.21	5.19	4.81	4.72	4.62	4.81	4.72	4.62
	Water outlet to 55°C		3.31	3.52	3.36	3.49	3.45	3.47	3.41	3.45	3.47	3.41
Sound level		dB(A)	56	58	59	60	64	65	68	64	65	68
Sound pressure level at 1m		dB(A)	44	45	46	49	50	51	55	50	51	55

<b>OPERATING LIMITS</b>												
Outdoor temperature	Cooling	°C	-5/43				-5/43					
	Heating	°C	-25/35				-25/35					
	DHW	°C	-25/43				-25/43					

<b>Power supply</b>												
Phase/Voltage/Frequency			1P/220-240V/50Hz				1P/220-240V/50Hz			3P/380-415V/50Hz		
Max. current	A		14		17		25	26	27	10	11	12

<b>INSTALLATION &amp; OTHERS</b>														
Airflow	m³/h		2770		4030		4060	4650		4060	4650			
<b>Refrigerant/GWP</b>			<b>R32/675</b>				<b>R32/675</b>							
Charge (15m)	kg		1.50		1.65		1.84							
Additional charge	g/m		20		38		38							
Unit dimensions (WxHxD)	mm		1008x712x426			1118x865x523			1118x865x523					
Package dimensions (WxHxD)	mm		1065x800x485			1180x890x560			1180x890x560					
Net weight/Gross weight	kg		58/64			77/88			96/110			112/125		
Pipe diameter (liquid - gas)	inches		1/4" - 5/8"			3/8" - 5/8"			3/8" - 5/8"					

INDOOR UNIT		AW-WHPSA0406-N91	AW-WHPSA0810-N91	AW-WHPSA1216-N91	AW-WHPSA1216-N93
<b>Part number</b>		<b>7HP010015</b>	<b>7HP010016</b>	<b>7HP010017</b>	<b>7HP010018</b>
<b>Phase</b>		Single-phase	Single-phase	Single-phase	Three-phase

<b>PERFORMANCE</b>					
Sound level	dB(A)	38	42	43	43
Sound pressure level (1m)		28	30	32	32

<b>POWER SUPPLY</b>							
Phase/Voltage/Frequency		1P/220-240V/50Hz		1P/220-240V/50Hz		3P/380-415V/50Hz	
Electric backup heater	kW	3	3	3	3/6/9		
Max. current		14.30	14.30	14.30	14.00		

<b>INSTALLATION &amp; OTHERS</b>						
Unit dimensions (WxHxD)	mm	420x790x270			420x790x270	
Package dimensions (WxHxD)	mm	525x1050x360			525x1050x360	
Net weight/Gross weight	kg	43/49			45/51	



Reversible  
heat pump

A<sup>+++</sup>

**HYBRID**  
HOUSE by Airwell



**+ PRODUCT**

- RCW29 remote control included
- Water outlet up to 60 °C at outdoor temperature -15 °C
- Compatible with all transmitter types
- Electrical resistor included from 8 kW

**FEATURES**



WEEKLY TIMER



COOLING MODE  
OPERATIONAL UP TO  
46 °C OUTDOORS



HEATING MODE  
OPERATIONAL DOWN  
TO -25 °C OUTDOORS



HIGH TEMPERATURE  
UP TO 60 °C



FLOOR HEATING



HIGH-TEMPERATURE  
RADIATOR



LOW-TEMPERATURE  
RADIATOR



BOILER BACK-UP



SUPER QUIET



WI-FI



WATER PROGRAMS

# WELLEA MONOBLOCK

## Monoblock heat pump



RCW29  
included



4-6 kW



8-16 kW



**+ «SUSTAINABLE DEVELOPMENT»**

- > High energy class A+++.

**+ «USER»**

- > Compatible with all transmitters.
- > Great flexibility of use.
- > Perfect for replacing an oil or gas boiler.

**+ «INSTALLER»**

- > Customizable water program.
- > Manage the entire heating circuit, thanks to the many available connections.

**+ «TECHNOLOGY»**

- > Operates at outdoor temperatures down to -25 °C.
- > HP Keymark certified.

**SOUND PRESSURE**

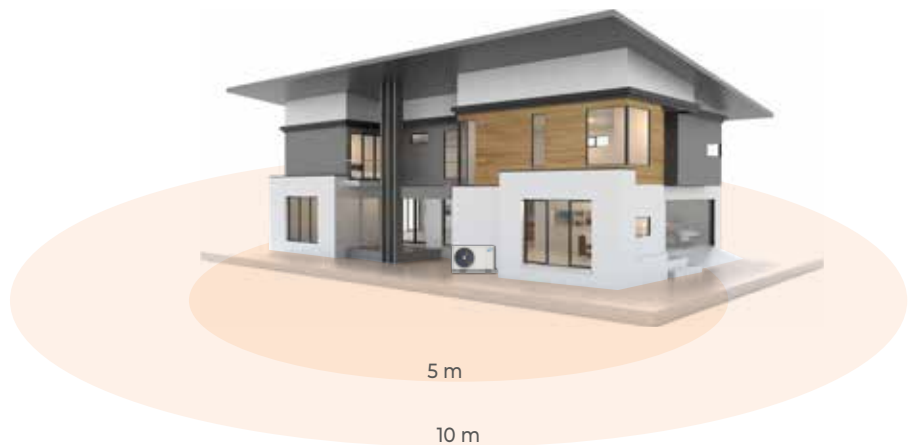

WELLEA MONOBLOCK		4 KW	6 KW	8 KW	10 KW	12 KW	14 KW	16 KW
Sound pressure level* at 5 m	dB(A)	30	31	34	35	37	38	42
Sound pressure level* at 10 m	dB(A)	15	16	19	20	22	23	27

\*Free field

## TECHNICAL DATA

MODEL	AW-WHPMA 04-H91	AW-WHPMA 06-H91	AW-WHPMA 08-H91	AW-WHPMA 10-H91	AW-WHPMA 12-H91	AW-WHPMA 14-H91	AW-WHPMA 16-H91	AW-WHPMA 12-H93	AW-WHPMA 14-H93	AW-WHPMA 16-H93	
<b>Part number</b>	<b>7HP061075</b>	<b>7HP061076</b>	<b>7HP061077</b>	<b>7HP061078</b>	<b>7HP061079</b>	<b>7HP061080</b>	<b>7HP061081</b>	<b>7HP061082</b>	<b>7HP061083</b>	<b>7HP061084</b>	
<b>Phase</b>	Single-phase				Single-phase			Three-phase			

### HEATING MODE

Air +7°C Water 30/35°C	Heating capacity	kW	4.20	6.35	8.40	10.00	12.10	14.50	15.90	12.10	14.50	15.90
	Power input	kW	0.82	1.28	1.63	2.02	2.44	3.15	3.53	2.44	3.15	3.53
	<b>COP</b>		<b>5.10</b>	<b>4.95</b>	<b>5.15</b>	<b>4.95</b>	<b>4.95</b>	<b>4.60</b>	<b>4.50</b>	<b>4.95</b>	<b>4.60</b>	<b>4.50</b>
Air -7°C Water 30/35°C	Heating capacity	kW	4.70	6.00	7.00	8.00	10.00	12.00	13.10	10.00	12.00	13.10
	Power input	kW	1.52	2.00	2.19	2.62	3.33	4.21	4.85	3.33	4.21	4.85
	<b>COP</b>		<b>3.10</b>	<b>3.00</b>	<b>3.20</b>	<b>3.05</b>	<b>3.00</b>	<b>2.85</b>	<b>2.70</b>	<b>3.00</b>	<b>2.85</b>	<b>2.70</b>
Air +7°C Water 47/55°C	Heating capacity	kW	4.40	6.00	7.50	9.50	12.00	13.80	16.00	12.00	13.80	16.00
	Power input	kW	1.49	2.00	2.36	3.06	3.87	4.60	5.52	3.87	4.60	5.52
	<b>COP</b>		<b>2.95</b>	<b>3.00</b>	<b>3.18</b>	<b>3.10</b>	<b>3.10</b>	<b>3.00</b>	<b>2.90</b>	<b>3.10</b>	<b>3.00</b>	<b>2.90</b>
Air -7°C Water 47/55°C	Heating capacity	kW	4.00	5.15	6.15	7.05	10.60	11.30	12.60	10.60	11.30	12.60
	Power input	kW	2.05	2.58	3.00	3.53	5.25	5.46	6.29	5.25	5.46	6.29
	<b>COP</b>		<b>1.95</b>	<b>2.00</b>	<b>2.05</b>	<b>1.97</b>	<b>2.02</b>	<b>2.01</b>	<b>2.00</b>	<b>2.02</b>	<b>2.01</b>	<b>2.00</b>

### COOLING MODE

Air 35°C Water 12/7°C	Cooling capacity	kW	4.70	7.00	7.45	8.20	11.50	12.40	14.00	11.50	12.40	14.00
	Power input	kW	1.36	2.33	2.22	2.52	4.18	4.96	5.60	4.18	4.96	5.60
	<b>EER</b>		<b>3.45</b>	<b>3.00</b>	<b>3.35</b>	<b>3.25</b>	<b>2.75</b>	<b>2.50</b>	<b>2.50</b>	<b>2.75</b>	<b>2.50</b>	<b>2.50</b>
Air 35°C Water 23/18°C	Cooling capacity	kW	4.50	6.50	8.30	9.90	12.00	13.50	14.90	12.00	13.50	14.90
	Power input	kW	0.82	1.35	1.64	2.18	3.04	3.75	4.38	3.04	3.75	4.38
	<b>EER</b>		<b>5.50</b>	<b>4.80</b>	<b>5.05</b>	<b>4.55</b>	<b>3.95</b>	<b>3.60</b>	<b>3.40</b>	<b>3.95</b>	<b>3.60</b>	<b>3.40</b>

### PERFORMANCE

Energy label (average climate)	Water outlet to 35°C		A+++				A+++					
	Water outlet to 55°C		A++				A++					
Seasonal efficiency (average climate)	Water outlet to 35°C	%	191	195	205	205	189	186	182	189	186	182
	Water outlet to 55°C	%	130	138	132	137	135	136	133	135	136	133
SCOP (average climate)	Water outlet to 35°C		4.85	4.95	5.21	5.19	4.81	4.72	4.62	4.81	4.72	4.62
	Water outlet to 55°C		3.31	3.52	3.36	3.49	3.45	3.47	3.41	3.45	3.47	3.41
Sound level		dB(A)	55	58	59	60	65	65	68	65	65	68
Sound pressure level at 1m		dB(A)	45	48	49	51	53	54	58	54	54	58

### OPERATING LIMITS

Outdoor temperature	Cooling	°C	-5/43				-5/43					
	Heating	°C	-25/35				-25/35					
	DHW	°C	-25/43				-25/43					

### POWER SUPPLY

Phase/Voltage/Frequency		1P/220-240V/50Hz				1P/220-240V/50Hz			3P/380-415V/50Hz			
Electric backup heater	kW	0		3		3			3/6/9			
Max. current	A	12	14	29	30	38	39	40	23	24	25	

### INSTALLATION & OTHERS

Airflow	m <sup>3</sup> /h	2770		4030		4060		4650		4060		4650	
<b>Refrigerant/GWP</b>		<b>R32/675</b>						<b>R32/675</b>					
Charge	kg	1.40			1.40			1.75					
Unit dimensions (WxHxD)	mm	1295x792x429			1385x945x526			1385x945x526					
Package dimensions (WxHxD)	mm	1375x965x475			1465x1120x560			1465x1120x560					
Net weight/Gross weight	kg	98/121			121/148			144/170			160/188		
Water pipe diameter	inches	R 1"			R 1 1/4			R 1 1/4			R 1 1/4		



Reversible  
heat pump

A+++

**HYBRID**  
HOUSE by Airwell



**+ PRODUCT**

- RCW29 remote control included
- Water at up to 60°C at outdoor temperatures down to -10°C
- Compatible with all transmitter types
- High power available

**FEATURES**



WEEKLY TIMER



COOLING MODE  
OPERATIONAL UP TO  
46°C OUTDOORS



HEATING MODE  
OPERATIONAL DOWN  
TO -25°C OUTDOORS



HIGH TEMPERATURE  
UP TO  
60°C



FLOOR HEATING



HIGH-TEMPERATURE  
RADIATOR



LOW-TEMPERATURE  
RADIATOR



BOILER BACK-UP



SUPER QUIET



WI-FI



WATER PROGRAMS

# WELLEA MONOBLOCK DF

Monoblock heat pump



18-30 kW



RCW29  
included



**+ «SUSTAINABLE DEVELOPMENT»**

- > High energy class A+++.

**+ «USER»**

- > Compatible with all transmitters.
- > Great flexibility of use.
- > Perfect for replacing an oil or gas boiler.

**+ «INSTALLER»**

- > Customizable water program.
- > Manage the entire heating circuit, thanks to the many available connections.

**+ «TECHNOLOGY»**

- > Operates at outdoor temperatures down to -25°C.
- > HP Keymark certified.

*ideal for renovating*  
**LARGE HOUSES**





## TECHNICAL DATA

MODEL		AW-WHPMA18-H93	AW-WHPMA22-H93	AW-WHPMA26-H93	AW-WHPMA30-H93	
Part number		7HP061085	7HP061086	7HP061087	7HP061088	
Phase		Three-phase				
<b>HEATING MODE</b>						
Air +7°C Water 30/35°C	Heating capacity	kW	18.30	22.30	26.30	29.93
	Power input	kW	3.96	5.13	6.50	8.02
	<b>COP</b>		<b>4.63</b>	<b>4.35</b>	<b>4.05</b>	<b>3.73</b>
Air -7°C Water 30/35°C	Heating capacity	kW	18.00	21.00	22.00	23.00
	Power input	kW	6.67	8.08	8.80	9.39
	<b>COP</b>		<b>2.70</b>	<b>2.60</b>	<b>2.50</b>	<b>2.45</b>
Air +7°C Water 47/55°C	Heating capacity	kW	18.10	22.10	26.06	29.68
	Power input	kW	6.63	8.33	10.72	12.97
	<b>COP</b>		<b>2.73</b>	<b>2.65</b>	<b>2.43</b>	<b>2.29</b>
Air -7°C Water 47/55°C	Heating capacity	kW	10.70	13.50	16.70	22.30
	Power input	kW	8.78	10.40	12.20	14.10
	<b>COP</b>		<b>1.22</b>	<b>1.30</b>	<b>1.37</b>	<b>1.58</b>
<b>COOLING MODE</b>						
Air 35°C Water 12/7°C	Cooling capacity	kW	17.00	21.00	26.00	29.50
	Power input	kW	5.57	7.12	9.63	11.57
	<b>EER</b>		<b>3.05</b>	<b>2.95</b>	<b>2.70</b>	<b>2.55</b>
Air 35°C Water 23/18°C	Cooling capacity	kW	18.50	23.00	27.00	31.00
	Power input	kW	3.90	5.00	6.28	7.75
	<b>EER</b>		<b>4.75</b>	<b>4.60</b>	<b>4.30</b>	<b>4.00</b>
<b>PERFORMANCE</b>						
Energy label (average climate)	Water outlet to 35°C		A+++			A++
	Water outlet to 55°C		A++			A+
Seasonal efficiency (average climate)	Water outlet to 35°C	%	181	178	177	165
	Water outlet to 55°C	%	125	126	123	123
SCOP (average climate)	Water outlet to 35°C		4.60	4.53	4.50	4.19
	Water outlet to 55°C		3.21	3.22	3.14	3.14
Sound level		dB(A)	71	73	75	77
Sound pressure level at 1m		dB(A)	58	60	62	64
<b>OPERATING LIMITS</b>						
Outdoor temperature	Cooling	°C	-5/46			
	Heating	°C	-25/35			
	DHW	°C	-25/43			
<b>POWER SUPPLY</b>						
Phase/Voltage/Frequency		3P/380-415V/50Hz				
Max. current	A	21.00	24.50	27.00	28.50	
<b>INSTALLATION &amp; OTHERS</b>						
Airflow	m³/h	10650		11200		
<b>Refrigerant/GWP</b>		<b>R32/675</b>				
Charge	kg	5				
Unit dimensions (WxHxD)	mm	1129x1558x440				
Package dimensions (WxHxD)	mm	1220x1735x565				
Net weight/Gross weight	kg	177/206				
Water pipe diameter	inches	R1-1/4"				

Wellea Monoblock DF

Air/Water-cooled  
heat pump &  
DHW



Domestic hot water production

A<sup>+</sup>

**HYBRID**  
HOUSE by Airwell



**+ PRODUCT**

- Excellent COP
- Small footprint
- Anti-legionella function
- No refrigerant handling
- Limescale protection

**FEATURES**



DOMESTIC HOT WATER

# TDF ELEO

## Thermodynamic water heater



TDF

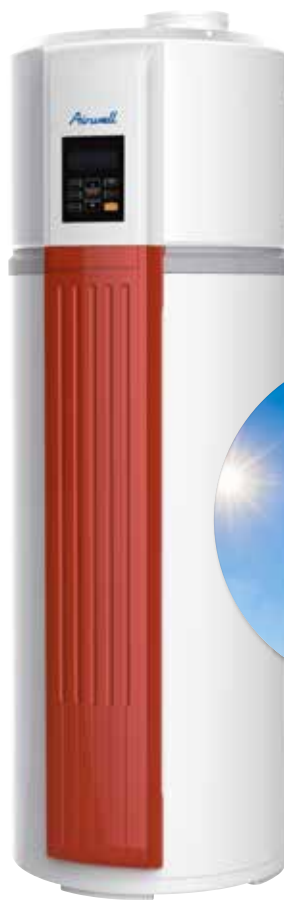

TDF SOLAR

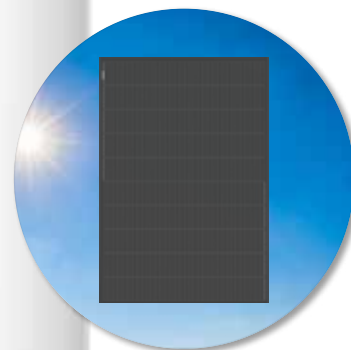

AirHome connectivity

**+ «SUSTAINABLE DEVELOPMENT»**

- > High energy class A+.
- > High-performance product with COP > 4.
- > Product 3 to 4 times more economical than an electric tank.

**+ «USER»**

- > Perfect to replace an electric tank.
- > “Peak/Off peak” operation.

**+ «INSTALLER»**

- > Easy to install thanks to its compact footprint.
- > Narrow diameter, fits through any doors.
- > Built-in limescale protection (electronic anode).

**+ «TECHNOLOGY»**

- > No risk of contamination following a refrigerant leak, thanks to the external exchanger.

**ACCESSORIES/OPTIONS**

ACCESSORY	PART NUMBER
Adapter kit, 90° bend and 1m duct (TDF 190)	7ACEL1735
Adapter kit, 90° bend and 1m duct (TDF 300)	7ACEL1737
Extention kit 1m duct (TDF 190)	7ACEL1736
Extention kit 1m duct (TDF 300)	7ACEL1738

## TECHNICAL DATA

INDOOR UNITS		AW-TDF190-H31	AW-TDF300-H31	AW-TDF190S-H31	AW-TDF300S-H31
<b>Part number</b>		<b>7HP030016</b>	<b>7HP030017</b>	<b>7HP030018</b>	<b>7HP030019</b>
<b>Phase</b>		Single-phase	Single-phase	Single-phase	Single-phase
<b>AIR +7°C WATER 10/55°C</b>					
Heating capacity	kW	1.362	1.814	1.362	1.814
Totale power input	kW	0.423	0.519	0.423	0.519
<b>COP</b>		<b>3.22</b>	<b>3.49</b>	<b>3.22</b>	<b>3.49</b>
<b>AIR +15°C WATER 10/55°C</b>					
Heating capacity	kW	1.609	2.185	1.609	2.185
Totale power input	kW	0.439	0.541	0.439	0.541
<b>COP</b>		<b>3.66</b>	<b>4.04</b>	<b>3.66</b>	<b>4.04</b>
<b>PERFORMANCE (AVERAGE CLIMATE)</b>					
DHW profil		L	XL	L	XL
Energy label		<b>A+</b>	<b>A+</b>	<b>A+</b>	<b>A+</b>
Seasonal efficiency	%	115	123	115	123
<b>COP</b>		<b>2.76</b>	<b>3.01</b>	<b>2.76</b>	<b>3.01</b>
Annual consumption	kWh	890	1361	890	1361
Heating time	h:mm	7:01	7:49	7:01	7:49
Standby power consumption	W	26.3	30.6	26.3	30.6
Reference hot water temperature	°C	53.8	53.1	53.8	53.1
DHW volume	l	176	284	168	272
Mixed water at 40 °C	l	234	354	234	354
<b>PERFORMANCE (WARMER CLIMATE)</b>					
Seasonal efficiency	%	130	148	130	148
<b>COP</b>		<b>3.13</b>	<b>3.59</b>	<b>3.13</b>	<b>3.59</b>
Annual consumption	kWh	785	1131	785	1131
<b>PERFORMANCE (COOLER CLIMATE)</b>					
Seasonal efficiency	%	99	95	99	95
<b>COP</b>		<b>2.36</b>	<b>2.32</b>	<b>2.36</b>	<b>2.32</b>
Annual consumption	kWh	1032	1759	1032	1759
<b>SOUND LEVEL</b>					
Sound pressure level (1m)	dB(A)	36.60	38.20	36.60	38.20
Sound level	dB(A)	51	53	51	53
<b>OPERATING LIMITS</b>					
Outdoor temperature (min./max.)	°C	-7° / 43°	-7° / 43°	-7° / 43°	-7° / 43°
Max. water temperature (with heat pump)	°C	70	65	70	65
<b>REFRIGERANT INFORMATION</b>					
<b>Refrigerant/GWP</b>		<b>R134A/1430</b>	<b>R134A/1430</b>	<b>R134A/1430</b>	<b>R134A/1430</b>
Charge	kg	1.10	1.50	1.10	1.50
<b>POWER SUPPLY</b>					
Phase/Voltage/Frequency		1P/220-240/50Hz	1P/220-240/50Hz	1P/220-240/50Hz	1P/220-240/50Hz
Electric backup heater	kW	3	3	3	3
Power cable	mm <sup>2</sup>	3x4	3x4	3x4	3x4
Max. current	A	30	30	30	30
<b>DIMENSIONS</b>					
Size (HxØ)	mm	1830x560	1930x650	1830x560	1930x650
Package dimensions (WxHxD)	mm	680x2070x680	775x2200x745	680x2070x680	775x2200x745
Net weight/Gross weight	kg	92/114	114/138	109/131	134/158
<b>SOLAR EXCHANGER SURFACE AREA</b>					
Dimension	m <sup>2</sup>	-	-	1.1	1.3
<b>FAN</b>					
Type		centrifugal	centrifugal	centrifugal	centrifugal
Airflow	m <sup>3</sup> /h	270	414	270	414
Static pressure	Pa	25	45	25	45

TDF E1e0

Air/Water-cooled  
heat pump &  
DHW

### 1 Inlet and outlet ducted





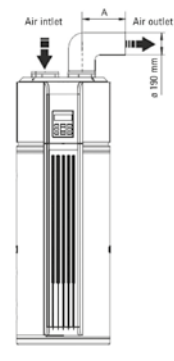
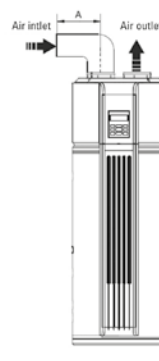
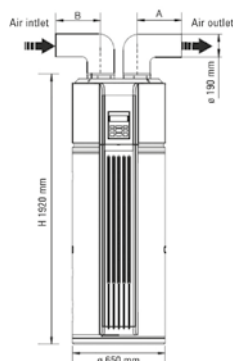







### 2 Inlet ducted

### 3 Outlet ducted



<b>TROOM TYPE FOR INSTALLATION</b>	<ul style="list-style-type: none"> <li>• Heated low volume room (&lt; 20 m<sup>3</sup>)</li> </ul>	<ul style="list-style-type: none"> <li>• Low volume room (&lt; 20 m<sup>3</sup>) and which can be cooled</li> </ul>	<ul style="list-style-type: none"> <li>• Heated high volume room (&gt; 20 m<sup>3</sup>) (kitchen, bathroom...)</li> </ul>
<b>AIR INLET AND AIR OUTLET</b>	<ul style="list-style-type: none"> <li>• Air inlet: outdoor air</li> <li>• Air outlet: to adjacent room or outdoors</li> </ul>	<ul style="list-style-type: none"> <li>• Air inlet: outdoor air</li> <li>• Air outlet: in the room (ambient air)</li> </ul>	<ul style="list-style-type: none"> <li>• Air inlet: ambient air</li> <li>• Air outlet: to adjacent room or outdoors</li> </ul>

## ACCESSORIES

DESIGNATION	PART NUMBER	PICTURE	FUNCTIONS
Bizone Kit 2ZZT	7ACEL1882		<ul style="list-style-type: none"> <li>This module makes it simple to manage 2 zones with 2 different temperatures (e.g.: floor heating &amp; radiator).</li> <li>All the components are pre-wired, you just have to plug them in.</li> <li>1 hydraulic module:                             <ul style="list-style-type: none"> <li>- 2 condensate pumps</li> <li>- 1 regulator</li> <li>- 2 thermostats (radio)</li> <li>- 1 outdoor temperature sensor (radio)</li> <li>- 1 antenna (for radio connection)</li> </ul> </li> <li>Thermostat functions:                             <ul style="list-style-type: none"> <li>- Temperature change (5 C to 37 C)</li> <li>- Mode switch (heating / air conditioning)</li> <li>- Weekly programming</li> <li>- Holiday mode</li> </ul> </li> </ul>
Hydraulic compensator	7ACFH0854		<ul style="list-style-type: none"> <li>To be use with the Bizone Kit.</li> <li>If you don't have a buffer tank you can use this compensator. Easy to pair with our Bizone Kit.</li> <li>14 kW <math>\Delta T</math> 5°C – 28 kW <math>\Delta T</math> 10°C</li> </ul>
3 ways valve	7ACFH0855		<ul style="list-style-type: none"> <li>3 ways valve for heating and DHW</li> </ul>
Magnetic dirt separator 1"	7ACFH0856		<ul style="list-style-type: none"> <li>Dirt separator, swiveling, with magnetic ring</li> </ul>
Antifreeze valve MM 1"	7ACFH0857		<ul style="list-style-type: none"> <li>Ready to install</li> <li>Thermostatic valve</li> <li>Automatic opening (+ 3 ° C) and closing (+ 4 ° C) (+/- 1 ° C)</li> </ul>
Automatic air vent 1"	7ACFH0862		<ul style="list-style-type: none"> <li>Continuous degassing of air present in the hydraulic circuit</li> <li>Automatic operation</li> <li>Swivelling: horizontal or vertical mounting</li> </ul>
Mix bottle 25 L	7ACFH0859		<ul style="list-style-type: none"> <li>Insulated bottle, reversible: heating and cooling</li> <li>ErP class: C</li> <li>Usable volume: 25 L</li> <li>Wall installation</li> </ul>
Mix bottle 50 L	7ACFH0858		<ul style="list-style-type: none"> <li>Insulated bottle, reversible: heating and cooling</li> <li>ErP class: C</li> <li>Usable volume: 51 L</li> <li>Wall installation</li> </ul>
Mix bottle 100 L	7ACFH0860		<ul style="list-style-type: none"> <li>Insulated bottle, reversible: heating and cooling</li> <li>ErP class: C</li> <li>Usable volume: 95 L</li> <li>Floor installation</li> </ul>
Mix bottle 200 L	7ACFH0861		<ul style="list-style-type: none"> <li>Insulated bottle, reversible: heating and cooling</li> <li>ErP class: C</li> <li>Usable volume: 195 L</li> <li>Floor installation</li> </ul>
Safety valve 10B 20X27	7ACFH0863		<ul style="list-style-type: none"> <li>Installation power: 46 kW</li> <li>Graduated adjustment scale: 0.1 to 0.6 bar differential</li> </ul>
Expansion vessel 12 L	7ACFH0864		<ul style="list-style-type: none"> <li>CE standard vessel for heating and cooling circuit</li> <li>Capacity: 12 L</li> <li>Pre-inflation: 1 bar</li> </ul>
Expansion vessel 18 L	7ACFH0865		<ul style="list-style-type: none"> <li>CE standard vessel for heating and cooling circuit</li> <li>Capacity: 18 L</li> <li>Pre-inflation: 1 bar</li> </ul>
Wall support for expansion vessel	7ACFH0866		<ul style="list-style-type: none"> <li>Arm, vessel bracket, equipped with:                             <ul style="list-style-type: none"> <li>- quick-release coupling for vessel</li> <li>- PR2 air bleed</li> <li>- NC valve with pressure gauge</li> </ul> </li> </ul>
Backflow preventer 1/2	7ACFH0867		<ul style="list-style-type: none"> <li>Non-controllable reduced pressure zone backflow preventer</li> <li>NF</li> </ul>

## ACCESSORIES

DESIGNATION	PART NUMBER	PICTURE	FUNCTIONS
Condensate pump EVOSTA 2 4 to 7 mH2O 180 mm	7ACFH0868		<ul style="list-style-type: none"> <li>• Low consumption electronic circulator (EEI &lt;= 0.18)</li> <li>• For heating and air conditioning</li> <li>• With limescale protection during commissioning</li> <li>• 5 year warranty</li> <li>• Flowrate: 0.4 to 3.6 m<sup>3</sup> / h</li> <li>• Manometric head: 4 to 6.9 mWp</li> <li>• 3 operating curves each with 3 speeds:                             <ul style="list-style-type: none"> <li>- Proportional differential pressure</li> <li>- Constant differential pressure</li> <li>- Constant speed</li> </ul> </li> <li>• Protection class: IP X5</li> </ul>
Axial thermometer 100 immersion 200	7ACFH0869		<ul style="list-style-type: none"> <li>• Axial thermometer</li> <li>• Display 0/120°</li> </ul>
Shock absorber (support)	7ACTL0510		<ul style="list-style-type: none"> <li>• Helps reduce the transmission of vibrations.</li> <li>Length: 1 000mm</li> </ul>
Line electrical heater - 3kW	7ACFH0822		<ul style="list-style-type: none"> <li>• Provides additional heating when the heating demand is greater than the heat pump capacity</li> </ul>
Remote control RCW29	7ACEL1896		<ul style="list-style-type: none"> <li>• On/Off control, additional heating</li> <li>• Operating mode: cooling / heating / automatic</li> <li>• DHW parameters: forced mode / holiday / anti-legionella / DHW pump</li> <li>• Temperature parameter: water outlet, set temperature</li> <li>• Timer: 12/24h</li> <li>• On/Off timer, daily / weekly</li> <li>• Display of different temperatures</li> <li>• Probe values display</li> <li>• Fault codes</li> <li>• Maintenance mode</li> </ul>
Temperature sensor	1PR070230		<ul style="list-style-type: none"> <li>• Temperature sensor + cable (10m)</li> </ul>
Cable extension (mixing tank)	7ACFH0870		<ul style="list-style-type: none"> <li>• Connection between temperature sensor and electronic board for mixing tank probe</li> </ul>
Cable extension (solar)	7ACFH0871		<ul style="list-style-type: none"> <li>• Connection between temperature sensor and electronic board for solar probe</li> </ul>
DHW electric heater control panel	7ACEL1892		<ul style="list-style-type: none"> <li>• Control the DHW electric heater with the heat pump</li> </ul>

Air/Water-cooled  
heat pump &  
DHW



DESIGNATION		DHW TANK 200L	DHW TANK 200S	DHW TANK 300L	DHW TANK 300S	DHW TANK 500L	DHW TANK 500S
<b>Part number</b>		<b>7ACFH0872</b>	<b>7ACFH0876</b>	<b>7ACFH0873</b>	<b>7ACFH0875</b>	<b>7ACFH0874</b>	<b>7ACFH0877</b>
Heat pump max. capacity	kW	10	10	16	16	22	22
Volume	L	196	194	273	267	475	464
Exchanger surface area	m <sup>2</sup>	1.5	1.5+0.5	1.8	1.8+1.1	2.2	2.2+1.3
Material		enamelled steel	enamelled steel	enamelled steel	enamelled steel	enamelled steel	enamelled steel
Max. pressure	bar	10	10	10	10	10	10
Static losses	W	51	51	63	63	80	80
Energy label		B	B	B	B	B	B
Protection		magnesium anode	magnesium anode	magnesium anode	magnesium anode	magnesium anode	magnesium anode
Electric heater	kW	2.0	2.0	2.0	2.0	2.0	2.0
Height	mm	1215	1215	1615	1615	1705	1705
Diameter	mm	640	640	640	640	790	790
Weight	kg	77	83	98	112	128	151



# HIGH WALL

## Range



	MODEL	REFERENCE	REFRIGERANT TYPE	7 2	9 2.5	12 3.5	18 5	24 7	kBTU/h kW
p.48		HDMB Harmonia	R32		•	•	•	•	
	<b>HIGH WALL</b> <i>Optimal design and comfort: new colour range, built-in ionizer, high filtration, Wi-Fi</i>								
p.50		HDLA Aura	R32		•	•	•	•	
	<b>HIGH WALL</b> <i>Operates with a low environmental impact refrigerant</i>								
p.52		HDLE Aura	R32	•	•	•	•	•	
	<b>MURAL</b> <i>Solution with Built-in Wi-Fi</i>								



DC Inverter  
Reversible

A+++

**HYBRID**  
HOUSE by Airwell

# HDMB HARMONIA

## Colour range High wall



RC08C  
included

*Complete sets:*

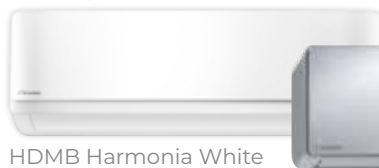

HDMB Harmonia White



HDMB Harmonia Mirror



HDMB Harmonia Grey

*Build your device:*

### 1 CHOOSE COLOR OF YOUR INDOOR UNIT

### 2 THEN SELECT THE PANEL COLOUR REFERENCE



HDMB Harmonia White



HDMB Harmonia Grey



Silver Grey



Champagne Beige



Passion Red

### + PRODUCT

- RC08C remote control included (see page 112)
- Design
- Performance
- Air quality (ionizer + filters)
- Quiet
- Compatible with YDZC and ZDAA multisplits

### FEATURES

#### TECHNOLOGY



4D AIRFLOW



GOLDEN FIN TREATMENT

#### AIR QUALITY/CLEAN



IONIZER



ANTIBACTERIAL FILTER



AUTO CLEAN/DRY

#### USER FUNCTIONS



Wi-Fi



24 H PROGRAMMABLE TIMER



I FEEL



NIGHT MODE



SUPER QUIET



REMOTE CONTROL LOCK



REFRIGERANT LEAKAGE DETECTOR



AUTO RESTART (MEMORY)

#### INSTALLER FUNCTIONS



ERROR PART NUMBER VIA INDOOR UNIT



AUTO-DIAGNOSTIC



LEFT/RIGHT CONDENSATE CONNECTION



HEATING ONLY MODE

### CERTIFICATION

- AIRWELL participates in the ECP programme for ACI. Check ongoing validity of certificate: [www.eurovent-certification.com](http://www.eurovent-certification.com)



- Certified in Monosplit configuration

#### + «SUSTAINABLE DEVELOPMENT»

- > High seasonal performance (SEER/SCOP).
- > Energy label A+++ in cooling mode and A++ in heating mode depending on model, guaranteeing energy savings.
- > Environmentally friendly R32 refrigerant.

#### + «USER»

- > Contemporary design to fit any interior.
- > High-performance ionizer and filters for better air quality.
- > Multi-directional air louvers for air distribution throughout the room.
- > Wi-Fi included for remote control of the unit.
- > Low noise level ideal for living rooms (bedroom, office, living room, etc.).

#### + «TECHNOLOGY»

- > Room sensor built into the remote control for better comfort ("I Feel" mode).
- > Automatic cleaning of heat exchangers for better hygiene and performance.
- > Golden Fin treatment on the heat exchangers (external and internal) for protection against corrosion and durability over time.

#### + «INSTALLER»

- > Installer mode for direct reading of the probes on the indoor unit.
- > Technician mode for setting the operating temperatures.
- > Condensate drain to the right or left for ease of installation in the room.







## TECHNICAL DATA

INDOOR UNIT - WHITE		HDMB-025N-09M22	HDMB-035N-09M22	HDMB-050N-09M22	HDMB-070N-09M22
Indoor unit part number - White		7SP023235	7SP023236	7SP023237	7SP023238
INDOOR UNIT - GREY		HDMB-025N-09M22-GY	HDMB-035N-09M22-GY	HDMB-050N-09M22-GY	HDMB-070N-09M22-GY
Indoor unit part number - Grey		7SP023244	7SP023245	7SP023246	7SP023247
INDOOR UNIT - MIRROR		HDMB-025N-09M22-MR	HDMB-035N-09M22-MR	HDMB-050N-09M22-MR	HDMB-070N-09M22-MR
Indoor unit part number - Mirror		7SP023240	7SP023241	7SP023242	7SP023243
Phase		Single-phase	Single-phase	Single-phase	Single-phase
COOLING					
Rated power (min./max.)	kW	2.64 (1.02~3.22)	3.51 (1.37~4.29)	5.27 (3.39~5.90)	7.03 (2.11~8.21)
Pdesignc	kW	2.60	3.50	5.30	7.00
Rated power input	kW	0.61	0.98	1.55	2.51
SEER/Energy label		9.30/A+++	8.5/A+++	7.0/A++	6.5/A++
Operating limits	°C	-15~50° Dry bulb			
HEATING					
Rated power (min./max.)	kW	2.92 (0.82~3.37)	3.81 (1.07~4.38)	5.57 (3.10~5.85)	7.33 (1.55~8.21)
Pdesignh (average climate)	kW	2.40	2.60	4.10	4.90
Pdesignh (warmer climate)	kW	2.70	3.00	4.50	5.30
Rated power input	kW	0.64	0.98	1.50	2.13
SCOP/Energy label (average climate)		4.60/A++	4.60/A++	4.00/A+	4.00/A+
SCOP/Energy label (warmer climate)		6.0/A+++	6.1/A+++	5.10/A+++	5.10/A+++
Operating limits	°C	-15~24° Dry bulb			
Power at -7°C	kW	2.19	2.30	3.67	4.39
Power at -10°C	kW	2.03	2.10	3.39	3.69
Power at -15°C	kW	1.62	1.68	2.71	2.95
INDOOR UNIT					
Sound pressure level at 1 m (VL/LS/MS/HS)	dB(A)	20/24/29/36.5	21/25/33/39.5	22/28/33.5/43	25/30.5/41.5/47
Sound level	dB(A)	55	55	58	63
Airflow (LS/MS/HS)	m³/h	303/362/483	395/477/584	420/500/730	640/830/1020
Dehumidification	l/h	0.9	1.2	1.8	2.4
Unit dimensions (WxHxD)	mm	802x297x189	802x297x189	965x319x215	1080x335x226
Package dimensions (WxHxD)	mm	875x380x285	875x380x285	1045x410x305	1155x420x415
Net weight/Gross weight	kg	8.6/11.3	8.6/11.3	10.9/12.5	13.7/17.5
PANEL					
Panel part number - Silver Grey		7ACTL0551	7ACTL0551	7ACTL0552	7ACTL0553
Panel part number - Champagne Beige		7ACTL0543	7ACTL0543	7ACTL0544	7ACTL0545
Panel part number - Passion Red		7ACTL0547	7ACTL0547	7ACTL0548	7ACTL0549

OUTDOOR UNIT		YDAB-025H-09M22	YDAB-035H-09M22	YDAB-050H-09M22	YDAB-070H-09M22
Part number		7SP063155	7SP063156	7SP063157	7SP063158
Sound pressure level at 1 m	dB(A)	49	51	53	55
Sound level	dB(A)	60	62	64	66
Airflow	m³/h	2150	2200	2100	3500
Compressor type		Rotary	Rotary	Rotary	Rotary
Unit dimensions (WxHxD)	mm	765x555x303	765x555x303	805x554x330	890x673x342
Package dimensions (WxHxD)	mm	887x610x337	887x610x337	915x615x370	995x740x398
Net weight/Gross weight	kg	26.4/29.5	26.4/29.5	32.8/36.2	43.9/46.9
POWER SUPPLY					
Phase/Voltage/Frequency		1P/220-240V/50-60Hz	1P/220-240V/50-60Hz	1P/220-240V/50-60Hz	1P/220-240V/50-60Hz
Power supply side		Outdoor	Outdoor	Outdoor	Outdoor
Power cable section	mm²	3x1.5	3x1.5	3x1.5	3x2.5
Max. current (D curve)	A	10	16	16	20
Shielded electrical connections	mm²	5x1.5	5x1.5	5x1.5	5x2.5
PIPE LINE					
Suction pipe diameter	inches	3/8"	3/8"	1/2"	5/8"
Liquid pipe diameter	inches	1/4"	1/4"	1/4"	3/8"
Max. length	m	25	25	30	50
Max. height	m	10	10	20	25
Refrigerant/GWP		R32/675	R32/675	R32/675	R32/675
Charge (5 m)	kg	0.62	0.62	1.1	1.45
Additional charge	g/m	12	12	12	24

## OPTIONS

ACCESSORY	PART NUMBER	PICTURE	FUNCTION
Wired remote control RCW22	7ACEL1778		<ul style="list-style-type: none"> <li>Weekly timer, mode, fan speed, On/Off timer, "I Feel" function, temperature.</li> </ul>
Dry contact On/Off adapter (mandatory with RCW22)	7ACEL1788		<ul style="list-style-type: none"> <li>Air conditioning external control.</li> </ul>
Condensate pump FlowwatchDesign (gutter)	7ACTL0518		<ul style="list-style-type: none"> <li>Condensate evacuation from indoor units.</li> </ul>

## MATCHING

INDOOR UNIT

HIGH WALL



HDMB Colour range



COMPATIBLE WITH OUTDOOR UNIT

MONOSPLIT

MULTISPLIT



YDAB



ZDAA



YDZC

HDMB Harmonia - Colour range

High wall



DC Inverter  
Reversible

# HDLA AURA

High wall

A<sup>++</sup>

**HYBRID**  
HOUSE by Airwell



RC08C  
included

## + PRODUCT

- RC08C remote control included (see page 112)
- Design
- Performance
- Compatible with YDZC and ZDAA multisplits

## FEATURES

### TECHNOLOGY



GOLDEN FIN  
TREATMENT

### AIR QUALITY/CLEAN



ANTIBACTERIAL  
FILTER



AUTO  
CLEAN/DRY

### USER FUNCTIONS



24 H  
PROGRAMMABLE  
TIMER



I FEEL



NIGHT  
MODE



SUPER  
QUIET



REMOTE CONTROL  
LOCK



REFRIGERANT  
LEAKAGE DETECTOR



RESTART  
(MEMORY)

### INSTALLER FUNCTIONS



ERROR PART NUMBER  
VIA INDOOR UNIT



AUTO-DIAGNOSTIC



LEFT/RIGHT  
CONDENSATE  
CONNECTION



MODE  
CHAUD  
SEUIL

## CERTIFICATION

- AIRWELL participates in the ECP programme for AC1. Check ongoing validity of certificate:

[www.eurovent-certification.com](http://www.eurovent-certification.com)



- Certified in Monosplit configuration

## + «SUSTAINABLE DEVELOPMENT»

- > Energy label A++ in cooling mode and A+ in heating mode depending on model, guaranteeing energy savings.
- > Environmentally friendly R32 refrigerant.

## + «USER»

- > Modern and sleek design.
- > High-performance filters that trap dust and particles for better air quality.

## + «TECHNOLOGY»

- > Room sensor built into the remote control for better comfort ("I Feel" mode).
- > Automatic cleaning and drying of the indoor unit for better hygiene.
- > Golden Fin treatment on the heat exchangers (external and internal) for protection against corrosion and durability over time.

## + «INSTALLER»

- > Installer mode for direct reading of the probes on the indoor unit.
- > Technician mode for setting the operating temperatures.
- > Condensate drain to the right or left for ease of installation in the room.



AirHome connectivity

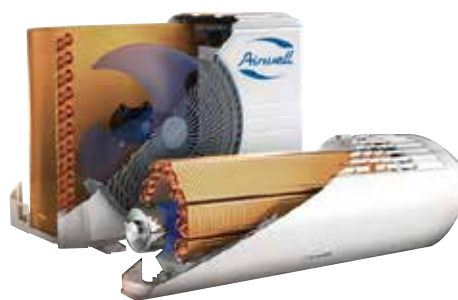

*Longer product service life:*

- > Golden Fin exchanger.
- > Anti-corrosion treatment on PCB.

## OPTIONS

ACCESSORY	PART NUMBER	PICTURE	FUNCTION
Wired remote control RCW8	7ACEL1706		• Fan speed mode, timer, on/off, temperature and swing.
AirHome WiFi module	7ACEL1744		• Control air conditioners with your mobile phone, tablet or computer via a wireless router and internet.
Condensate pump FlowwatchDesign (gutter)	7ACTL0518		• Condensate evacuation from indoor units.

## TECHNICAL DATA

HDLA Aura

High wall

INDOOR UNIT		HDLA-025N-09M25	HDLA-035N-09M25	HDLA-050N-09M25	HDLA-070N-09M25
Part number		7SP023250	7SP023251	7SP023252	7SP023253
Phase		Single-phase	Single-phase	Single-phase	Single-phase

### COOLING

Rated power (min./max.)	kW	2.64 (0.91~3.40)	3.52 (1.11~4.16)	5.28 (1.82~6.16)	7.03 (2.08~7.91)
Pdesignc	kW	2.80	3.60	5.20	7.00
Rated power input	kW	0.73	1.21	1.55	2.60
SEER/Energy label		6.30/A++	6.10/A++	7.40/A++	6.10/A++
Operating limits	°C	-15~50° Dry bulb			

### HEATING

Rated power (min./max.)	kW	2.93 (0.821~3.370)	3.81 (1.08~4.22)	5.57 (1.29~6.74)	7.33 (1.61~7.91)
Pdesignh (average climate)	kW	2.60	2.70	4.10	4.80
Pdesignh (warmer climate)		2.60	2.50	4.40	5.80
Rated power input	kW	0.73	1.09	1.57	2.40
SCOP/Energy label (average climate)		4.00/A+	4.00/A+	4.00/A+	4.00/A+
SCOP/Energy label (warmer climate)		5.10/A+++	5.10/A+++	5.10/A+++	4.80/A++
Operating limits	°C	-15~30° Dry bulb			
Power at -7°C	kW	2.29	2.39	3.68	4.25
Power at -10°C	kW	2.03	2.04	3.40	3.89
Power at -15°C	kW	1.63	1.64	2.72	3.11

### INDOOR UNIT

Sound pressure level at 1 m (VL/LS/MS/HS)	dB(A)	21/25/32/38.5	21/25/34.5/40.5	20/26/36/42.5	36/40.5/45
Sound level	dB(A)	54	55	56	59
Airflow (LS/MS/HS)	m³/h	325/360/466	314/430/540	540/680/840	662/817/980
Dehumidification	l/h	0.9	1.2	1.8	2.4
Unit dimensions (WxHxD)	mm	805x285x194	805x285x194	957x302x213	1040x327x220
Package dimensions (WxHxD)	mm	870x365x270	870x365x270	1035x385x295	1120x315x405
Net weight/Gross weight	kg	7.5/9.8	7.6/9.9	10.0/12.1	12.3/15.8

OUTDOOR UNIT		YDAA-025H-09M25	YDAA-035H-09M25	YDAA-050H-09M25	YDAA-070H-09M25
Part number		7SP063160	7SP063161	7SP063162	7SP063163
Sound pressure level at 1 m	dB(A)	51	52	52	56
Sound level	dB(A)	62	63	63	67
Airflow	m³/h	1750	1800	2100	3500
Compressor type		Rotary	Rotary	Rotary	Rotary
Unit dimensions (WxHxD)	mm	720x495x270	720x495x270	805x554x330	890x673x342
Package dimensions (WxHxD)	mm	835x540x300	835x540x300	915x615x370	995x740x398
Net weight/Gross weight	kg	23.2/25	23.2/25	32.7/35.4	42.9/45.9

### POWER SUPPLY

Phase/Voltage/Frequency		1P/220-240V/50Hz	1P/220-240V/50Hz	1P/220-240V/50Hz	1P/220-240V/50Hz
Power supply side		Outdoor	Outdoor	Outdoor	Outdoor
Power cable section	mm²	3x1.5	3x1.5	3x1.5	3x2.5
Max. current (D curve)	A	10	10	16	20
Shielded electrical connections	mm²	1.5x5	1.5x5	1.5x5	2.5x5

### PIPE LINE

Suction pipe diameter	inches	3/8"	3/8"	1/2"	5/8"
Liquid pipe diameter	inches	1/4"	1/4"	1/4"	3/8"
Max. length	m	25	25	30	50
Max. height	m	10	10	20	25
Refrigerant/GWP		R32/675	R32/675	R32/675	R32/675
Charge (5 m)	kg	0.55	0.55	1.08	1.42
Additional charge	g/m	12	12	12	24

### MATCHING





DC Inverter  
Reversible

A<sup>++</sup>

**HYBRID**  
HOUSE by Airwell

# HDLE AURA

High wall - Built-in Wi-Fi

► New HDLW designation!



RC08A  
included

## + PRODUCT

- RC08A remote control included (see page 114)
- Wide range from 2 to 6 kW
- Wi-Fi compatible (AirHome solution)
- Compatible with ZDAE multisplit

## FEATURES

### AIR QUALITY



AUTO CLEAN/DRY

### USER FUNCTIONS



Wi-Fi



PROGRAMMABLE  
TIMER



I FEEL



NIGHT MODE



SUPER QUIET



REMOTE CONTROL  
LOCK



AUTO RESTART  
(MEMORY)

### INSTALLER FUNCTIONS



ERROR PART NUMBER  
VIA INDOOR UNIT



AUTO-DIAGNOSTIC



LEFT/RIGHT  
CONDENSATE  
CONNECTION

## CERTIFICATION

- AIRWELL participates in the ECP programme for AC1. Check ongoing validity of certificate:  
[www.eurovent-certification.com](http://www.eurovent-certification.com)



- Certified in Monosplit configuration

Available according  
to country, contact us.

## + «SUSTAINABLE DEVELOPMENT»

- > Energy label A<sup>++</sup> in cooling mode and A<sup>+</sup> in heating mode depending on model, guaranteeing energy savings.
- > Environmentally friendly R32 refrigerant.

## + «USER»

- > Modern and sleek design.
- > High-performance filters that trap dust and particles for better air quality.

## + «TECHNOLOGY»

- > Room sensor built into the remote control for better comfort ("I Feel" mode).
- > Automatic cleaning and drying of the indoor unit for better hygiene.

## + «INSTALLER»

- > Condensate drain to the right or left for ease of installation in the room.



*Night mode:*

- > Improved comfort and energy savings

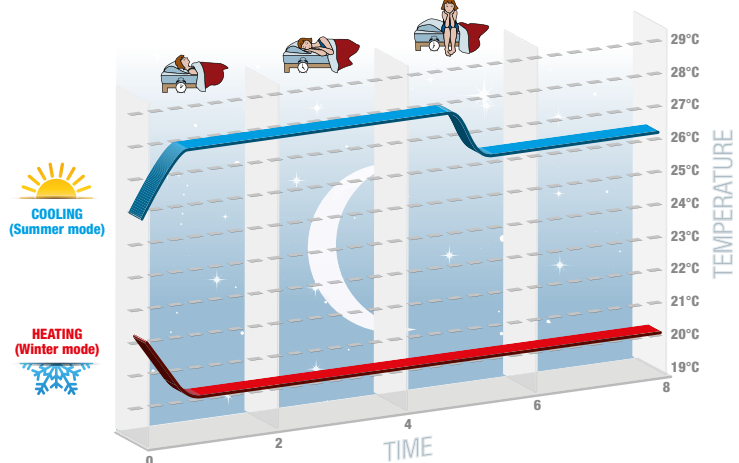

2021		2022	
Old designation	Old part number	New designation	New part number
<b>HDLW High wall range</b>		<b>HDLE High wall range</b>	
AW-HDLW007-N91	7SP023200	HDLE-022N-09M25	7SP023270
AW-HDLW009-N91	7SP023201	HDLE-025N-09M25	7SP023271
AW-HDLW012-N91	7SP023202	HDLE-035N-09M25	7SP023272
AW-HDLW018-N91	7SP023203	HDLE-050N-09M25	7SP023273
AW-HDLW024-N91	7SP023204	HDLE-070N-09M25	7SP023274
-	-	YDAE-022R-09M25	7SP063200
AW-YHDL009-H91	7SP062960	YDAE-025R-09M25	7SP063201
AW-YHDL012-H91	7SP062961	YDAE-035R-09M25	7SP063202
AW-YHDL018-H91	7SP062962	YDAE-050R-09M25	7SP063203
AW-YHDL024-H91	7SP062963	YDAE-070R-09M25	7SP063204

## TECHNICAL DATA

HDLE Aura

High wall

INDOOR UNIT		HDLE-022N-09M25	HDLE-025N-09M25	HDLE-035N-09M25	HDLE-050N-09M25	HDLE-070N-09M25
Part number		7SP023270	7SP023271	7SP023272	7SP023273	7SP023274
Phase		Single-phase	Single-phase	Single-phase	Single-phase	Single-phase
COOLING						
Rated power (min./max.)	kW	2.20 (0.30-2.85)	2.70 (0.60-3.40)	3.20 (0.90-3.60)	4.60 (1.00-5.30)	6.20 (1.80-6.90)
Pdesignnc	kW	2.20	2.70	3.20	4.60	6.20
Rated power input	kW	0.59	0.74	0.99	1.36	1.83
SEER/Energy label		6.60/A++	6.60/A++	6.10/A++	6.40/A++	6.80/A++
Operating limits	°C	-15°~43°C Dry bulb				
HEATING						
Rated power (min./max.)	kW	2.40 (0.60-2.90)	2.80 (0.60-3.70)	3.40 (0.90-4.00)	5.20 (1.00-5.65)	6.50 (1.30-7.03)
Pdesignnh (average climate)	kW	2.10	2.50	2.70	3.70	4.70
Pdesignnh (warmer climate)		2.10	2.80	2.80	3.60	4.70
Rated power input	kW	0.59	0.70	0.92	1.34	1.91
SCOP/Energy label (average climate)		4.00/A+	4.20/A+	4.00/A+	4.00/A+	4.00/A+
SCOP/Energy label (warmer climate)		4.80/A++	5.20/A++	4.90/A++	5.10/A++	5.10/A++
Operating limits	°C	-15°~24°C Dry bulb				
Power at -7°C	kW	2.18	2.28	2.51	4.51	5.13
Power at -10°C	kW	2.11	2.20	2.29	3.65	4.59
Power at -15°C	kW	1.80	1.88	1.95	3.53	4.43
INDOOR UNIT						
Sound pressure level at 1 m (VL/LS/MS/HS)	dB(A)	25/33/36/39	24/34/38/41	24/33/37/41	31/38/42/44	30/37/45/48
Sound level (VL/LS/MS/HS)	dB(A)	37/45/48/55	36/46/50/57	34/45/50/57	41/48/52/54	42/49/57/60
Airflow (VL/LS/MS/HS)	m³/h	290/420/470/500	280/400/520/550	280/410/480/590	550/700/800/850	400/600/800/900
Dehumidification	l/h	0.60	1.40	1.40	1.80	1.80
Unit dimensions (WxHxD)	mm	713x270x195	790x275x200	790x275x200	970x300x224	970x300x224
Package dimensions (WxHxD)	mm	776x362x268	866x367x271	866x367x271	1041x383x320	1041x383x320
Net weight/Gross weight	kg	8/9.5	9/11	9/11	13.5/16	13/15.5
OUTDOOR UNIT		YDAE-022R-09M25	YDAE-025R-09M25	YDAE-035R-09M25	YDAE-050R-09M25	YDAE-070R-09M25
Part number		7SP063200	7SP063201	7SP063202	7SP063203	7SP063204
Sound pressure level at 1 m	dB(A)	49	51	51	52	54
Sound level	dB(A)	60	62	64	63	65
Airflow	m³/h	1400	1950	1950	1950	2800
Compressor type		Rotary	Rotary	Rotary	Rotary	Rotary
Unit dimensions (WxHxD)	mm	710x450x293	732x550x330	732x550x330	732x555x330	873x555x376
Package dimensions (WxHxD)	mm	764x525x330	792x620x393	792x620x393	794x615x376	951x620x431
Net weight/Gross weight	kg	21/23	25/27.5	25/27.5	26.5/29	36.5/39.5
POWER SUPPLY						
Phase/Voltage/Frequency		1P/220-240V/50Hz	1P/220-240V/50Hz	1P/220-240V/50Hz	1P/220-240V/50Hz	1P/220-240V/50Hz
Power supply side		Outdoor	Outdoor	Outdoor	Outdoor	Outdoor
Power cable section	mm²	3x1.5	3x1.5	3x1.5	3x1.5	3x1.5
Max. current (D curve)	A	10	10	10	16	16
Shielded electrical connections	mm²	4x0.75	4x0.75	4x0.75	4x0.75	4x0.75
PIPE LINE						
Suction pipe diameter	inches	3/8"	3/8"	3/8"	3/8"	1/2"
Liquid pipe diameter	inches	1/4"	1/4"	1/4"	1/4"	1/4"
Max. length	m	15	15	15	25	25
Max. height	m	10	10	10	10	10
Refrigerant/GWP		R32/675	R32/675	R32/675	R32/675	R32/675
Charge (5 m)	kg	0.45	0.53	0.55	0.75	1.23
Additional charge	g/m	16	16	16	16	16

## OPTIONS

ACCESSORY	PART NUMBER	PICTURE	FUNCTION
Wired control RCW27 (see page 122)	7ACEL1874		• Weekly programming, mode setting, temperature setting, fan speed, key lock.

### MATCHING



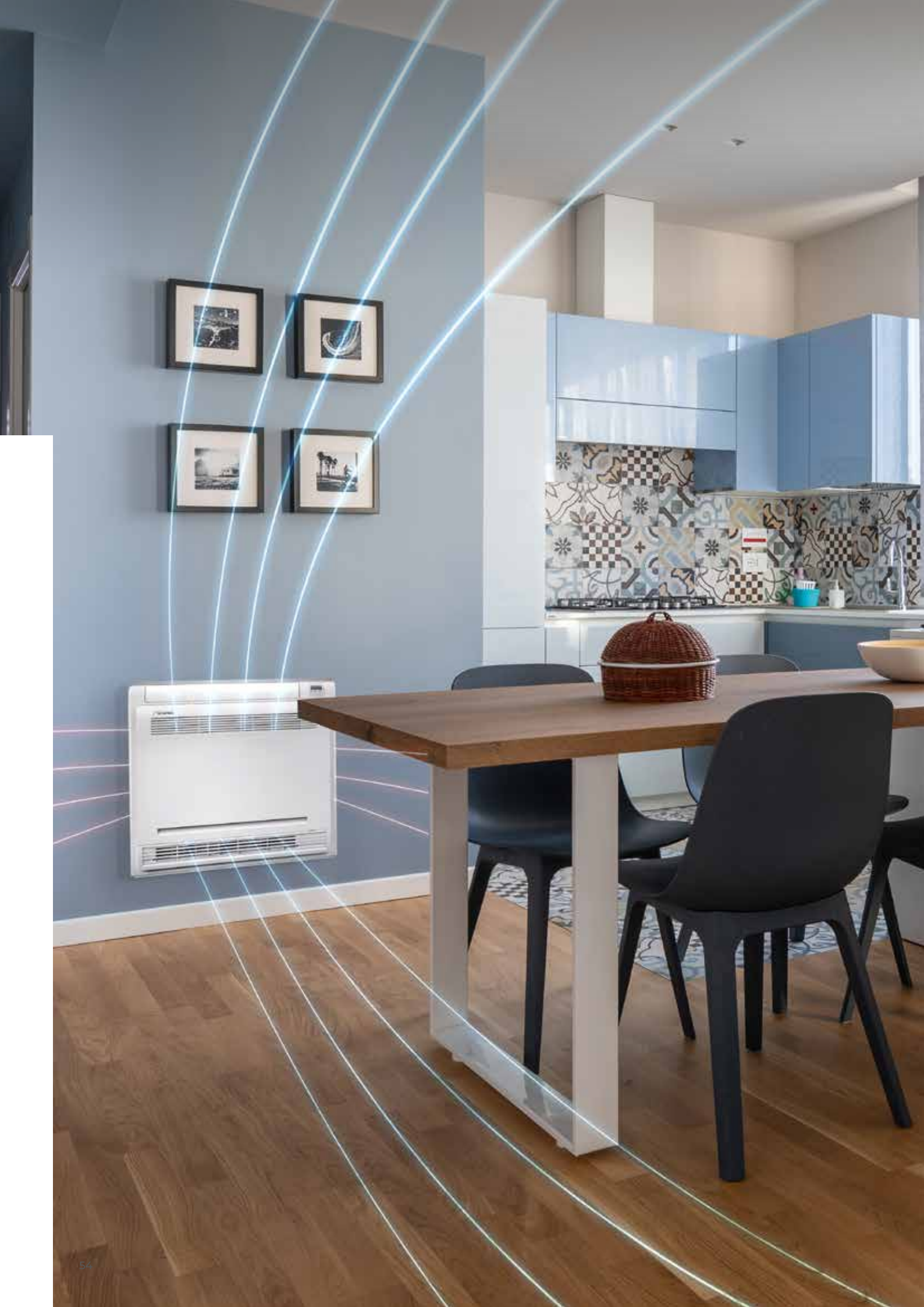

INDOOR UNIT HIGH WALL	COMPATIBLE WITH OUTDOOR UNIT		
	MONOSPLIT	MULTISPLIT	
 HDLE Aura	 YDAE	 ZDAE	 YDZB



# CONSOLE, FLOOR CEILING AND FLOOR STANDING

## Ranges



MODEL	REFRIGERANT TYPE	9 2,5	12 3.5	18 5	24 7	36 10	48 12.5	60 16	kBTU/h kW
<p>p.56</p>  <p><b>XDLF</b></p> <p>DUAL-FLOW CONSOLE</p> <p><i>ideal solution for replacing electric radiators</i></p>	R32	•	•	•					
<p>p.58</p>  <p><b>FDMX</b></p> <p>FLOOR CEILING</p> <p><i>Long-range blowing</i></p>	R32			•	•	•	•	•	
<p>p.60</p>  <p><b>FDLK</b></p> <p>LOW-TEMPERATURE FLOOR CEILING</p> <p><i>Solution for low-temperature rooms</i></p>	R32			•	•				
<p>p.62</p>  <p><b>SDMX</b></p> <p>FLOOR STANDING</p> <p><i>Solution for high-volume rooms</i></p>	R32						•		

Console  
Floor ceiling  
Floor standing



DC Inverter  
Reversible

A<sup>++</sup>

**HYBRID**  
HOUSE by Airwell

# XDLF

## Dual-flow console



RC08A  
included

### + PRODUCT

- RC08A remote control included (see page 114)
- Wide range (9/12/18)
- Dual-flow air supply
- Operate down to -22 °C
- Multisplit compatible
- Active charcoal filter

### FEATURES

#### TECHNOLOGY



FLEXY MATCH



ELECTRONIC EXPANSION VALVE

#### AIR QUALITY



NANO PHOTOCATALYTIC FILTER



ANTIBACTERIAL FILTER

#### USER FUNCTIONS



I FEEL



NIGHT MODE



SUPER QUIET



24 H PROGRAMMABLE TIMER



AUTO RESTART (MEMORY)



REMOTE CONTROL LOCK



WI-FI

#### INSTALLER FUNCTIONS



ERROR PART NUMBER VIA INDOOR UNIT



AUTO-DIAGNOSTIC

### CERTIFICATION

- AIRWELL participates in the ECP programme for AC1. Check ongoing validity of certificate:

[www.eurovent-certification.com](http://www.eurovent-certification.com)



- Certified in Monosplit configuration

Available according  
to country, contact us.

- + «USER»**
  - > User-friendly ("I Feel", Wi-Fi).
  - > Night mode.
- + «INSTALLER»**
  - > The best reliability on the market.
- + «TECHNOLOGY»**
  - > DC fan units.



AirHome connectivity

### OPTIONS

ACCESSORY	PART NUMBER	PICTURE	FUNCTION
Wired control RCW27 (see page 122)	7ACEL1874		<ul style="list-style-type: none"> <li>• Weekly programming, mode setting, temperature setting, fan speed, key lock.</li> </ul>



## TECHNICAL DATA

MULTISPLIT  
CONFIGURATION ONLY

INDOOR UNIT		XDLF-025N-09M25	XDLF-035N-09M25	XDLF-050N-09M25
<b>Part number</b>		<b>7SP071440</b>	<b>7SP071441</b>	<b>7SP071442</b>
<b>Phase</b>		<i>Monophasé</i>	<i>Monophasé</i>	<i>Monophasé</i>
<b>COOLING</b>				
<b>Rated power (min./max.)</b>	<b>kW</b>	<b>2.70 (0.7-3.4)</b>	<b>3.50 (0.8-4.4)</b>	<b>5.20 (1.3-6.6)</b>
Pdesignc	kW	-	3.50	5.20
Rated power input	kW	-	1.00	1.55
SEER/Energy label		-	<b>7.0/A++</b>	<b>6.6/A++</b>
Operating limits	°C	-	-15°/43° Dry bulb	
<b>HEATING</b>				
<b>Rated power (min./max.)</b>	<b>kW</b>	<b>2.90 (0.6-3.5)</b>	<b>3.80 (1.1-4.4)</b>	<b>5.33 (1.12-6.8)</b>
Pdesignh (average climate)	kW	-	3.20	5.00
Pdesignh (warmer climate)	kW	-	3.30	5.00
Rated power input	kW	-	0.96	1.50
SCOP/Energy label (average climate)		-	<b>4.1/A+</b>	<b>4.1/A+</b>
SCOP/Energy label (warmer climate)		-	<b>5.3/A+++</b>	<b>5.1/A+++</b>
Operating limits	°C	-	-22°/24° Dry bulb	
Power at -10°C	kW	-	3.34	4.69
Power at -15°C	kW	-	2.28	3.20
<b>INDOOR UNIT</b>				
Sound pressure level at 1 m (VL/LS/MS/HS)	dB(A)	23/26/33/39	25/29/38/44	32/37/43/47
Sound level (VL/LS/MS/HS)	dB(A)	34/38/45/50	35/39/48/54	42/47/53/57
Airflow (VL/LS/MS/HS)	m³/h	250/280/410/500	280/360/480/600	320/410/580/700
Dehumidification	l/h	0.80	1.20	1.80
Unit dimensions (WxHxD)	mm	700x600x215	700x600x215	700x600x215
Package dimensions (WxHxD)	mm	788x685x295	788x685x295	788x685x295
Net weight/Gross weight	kg	15.5/18.5	15.5/18.5	15.5/18.5

OUTDOOR UNIT		-	YDAF-035R-09M25	YDAF-050R-09M25
<b>Part number</b>		-	<b>7SP063205</b>	<b>7SP063206</b>
Sound pressure level at 1 m	dB(A)	-	52	57
Sound level	dB(A)	-	62	65
Airflow	m³/h	-	2200	3200
Compressor type		-	Rotary DCI	Rotary DCI
Unit dimensions (WxHxD)	mm	-	848x596x320	965x700x396
Package dimensions (WxHxD)	mm	-	881x645x363	1029x750x458
Net weight/Gross weight	kg	-	30.5/33.5	46/50.5
<b>POWER SUPPLY</b>				
Phase/Voltage/Frequency		1P/220-240V/50Hz	1P/220-240V/50Hz	1P/220-240V/50Hz
Power supply side		Outdoor	Outdoor	Outdoor
Power cable section	mm²	-	3x1.5	3x1.5
Max. current (D curve)	A	-	16	16
Electrical connections	mm²	4x1.5	4x1.5	4x1.5
<b>PIPE LINE</b>				
Suction pipe diameter	inches	3/8"	3/8"	1/2"
Liquid pipe diameter	inches	1/4"	1/4"	1/4"
Max. length	m	-	20	25
Max. height	m	-	10	10
<b>Refrigerant/GWP</b>		-	<b>R32/675</b>	<b>R32/675</b>
Charge (5 m)	kg	-	0.75	0.95
Additional charge	g/m	-	16	16

Warning: Unit not suitable for wet rooms such as bathrooms, kitchens, laundry rooms.

### MATCHING



### MATCHING



XDLF

Console  
Floor ceiling  
Floor standing



DC Inverter  
Reversible

# FDMX

## Floor ceiling



A<sup>++</sup>



RC18  
included

### + PRODUCT

- RC18 remote control included (see page 116)
- 2 positions: wall or ceiling mounted
- Slim
- Long distance air jet
- Compatible with YDZC and ZDAA multisplits

### FEATURES

#### TECHNOLOGY



FLEXY MATCH



ELECTRONIC EXPANSION VALVE



GOLDEN FIN TREATMENT

#### AIR QUALITY



ANTIBACTERIAL FILTER

#### USER FUNCTIONS



TIMER



I FEEL



NIGHT MODE



AUTO RESTART (MEMORY)

### CERTIFICATION

- AIRWELL participates in the ECP programme for AC1. Check ongoing validity of certificate: [www.eurovent-certification.com](http://www.eurovent-certification.com)



- Models marked \* are not Eurovent certified

### + «SUSTAINABLE DEVELOPMENT»

- > Energy label A++ in cooling mode and A+ in heating mode depending on model, guaranteeing energy savings.

### + «USER»

- > Discreet thanks to its small depth (235 mm).
- > Wall or ceiling installation ideal to suit the room configuration.

### + «INSTALLER»

- > Parameter reading.
- > Air louvers optimized for blowing up to 11 m.
- > Maximum piping length up to 75m adapted to complex and remote installation.

### + «TECHNOLOGY»

- > Multi-directional air louvers for air distribution throughout the room.
- > Room sensor built into the remote control for better comfort ("I Feel" mode).
- > On/off contact included associated with a "room card" or other solution (not supplied) for better control and for energy savings.
- > Alarm contact (synthesis fault) included.
- > Golden Fin treatment on the heat exchangers (external and internal) for protection against corrosion and durability over time.
- > Wide operating range of -15° to 50°C in cooling mode and -15° to 24°C in heating mode.



AirHome connectivity

### OPTIONS

ACCESSORY	PART NUMBER	PICTURE	FUNCTION
Wired remote control RCW11 (see page 120)	7ACEL1774		• Weekly timer, mode, fan speed, On/Off timer, "I Feel" function, temperature.
Condensate pump Mini Flowatch MF2	7ACTL0517		• Condensate evacuation from indoor units.
LCAC Wi-Fi accessory	7ACEL1883		• Accessory for remote control via Wi-Fi.

## TECHNICAL DATA

FDMX

INDOOR UNIT		FDMX-050N-09M25	FDMX-070N-09M25	FDMX-100N-09M25	FDMX-100N-09M25	FDMX-140N-09M25*	FDMX-175N-09M25*
Part number		7SP012300	7SP012301	7SP012302	7SP012302	7SP012303	7SP012304
Phase		Single-phase	Single-phase	Single-phase	Three-phase	Three-phase	Three-phase
COOLING							
Rated power (min./max.)	kW	5.28 (2.71~5.86)	7.03 (3.22~7.77)	10.55 (2.73~11.43)	10.55 (2.73~11.78)	14.07 (3.52~15.24)	15.83 (4.10~16.71)
Pdesignc	kW	5.40	7.20	10.50	10.50	14.00	15.50
Rated power input	kW	1.45	2.30	3.90	4.00	5.00	5.65
SEER/Energy label		6.2/A++	6.1/A++	6.4/A++	6.2/A++	6.1/A++	6.1/A++
Operating limits	°C	-15°~50°C Dry bulb					
HEATING							
Rated power (min./max.)	kW	5.57 (2.42~6.30)	7.62 (2.72~8.29)	11.72 (2.78~12.78)	11.72 (2.81~12.78)	16.12 (4.10~17.00)	18.17 (4.40~19.64)
Pdesignh (average climate)	kW	4.00	5.50	8.60	8.60	11.20	11.90
Pdesignh (warmer climate)	kW	5.10	5.80	10.20	10.00	11.70	12.60
Rated power input	kW	1.50	2.05	3.350	3.350	5.100	6.05
SCOP/Energy label (average climate)		4.0/A+	4.0/A+	4.1/A+	4.0/A+	3.9/A	4.0/A+
SCOP/Energy label (warmer climate)		5.1/A+++	5.1/A+++	5.1/A+++	5.1/A+++	5.1/A+++	5.1/A+++
Operating limits	°C	-15°~24°C Dry bulb					
Power at -7°C	kW	4.30	5.94	9.21	9.08	11.76	12.76
Power at -10°C	kW	3.60	5.04	7.45	7.40	10.91	11.55
Power at -15°C	kW	2.88	4.03	5.96	5.92	8.73	9.24
INDOOR UNIT							
Sound pressure level at 1 m (LS/MS/HS)	dB(A)	37/41/44	43/47/51	45/48/51.5	45/47.5/51	46/50/53	48/52/55
Sound level	dB(A)	59	55	65	65	67	67
Airflow (LS/MS/HS)	m³/h	723/839/958	853/1023/1192	1504/1728/1955	1504/1728/1955	1600/1850/2100	1650/1950/2200
Dehumidification	l/h	1.80	2.40	3.60	3.60	4.80	5.50
Unit dimensions (WxHxD)	mm	1068x675x235	1068x675x235	1650x675x235	1650x675x235	1650x675x235	1650x675x235
Package dimensions (WxHxD)	mm	1145x755x318	1145x755x318	1725x755x318	1725x755x318	1725x755x318	1725x755x318
Net weight/Gross weight	kg	28/33.4	28/33.2	41.5/48.1	41.5/48.1	41.7/48.6	42.3/49.3

OUTDOOR UNIT		YDAX-050H-09M25	YDAX-070H-09M25	YDAX-100H-09M25	YDAX-100H-09T35	YDAX-140H-09T35	YDAX-175H-09T35
Part number		7SP063171	7SP063172	7SP063173	7SP063174	7SP063175	7SP063176
Sound pressure level at 1 m	dB(A)	54	56	59	59	63	62
Sound level	dB(A)	65	67	70	74	74	73
Airflow	m³/h	2100	3500	4000	4000	7500	7500
Compressor type		Rotary	Rotary	Rotary	Rotary	Rotary	Rotary
Unit dimensions (WxHxD)	mm	805x554x330	890x673x342	946x810x410	946x810x410	952x1333x415	952x1333x415
Package dimensions (WxHxD)	mm	915x615x370	995x740x398	1090x885x500	1090x885x500	1095x1480x495	1095x1480x495
Net weight/Gross weight	kg	32.5/35.3	43.9/46.7	66.9/72.1	75.5/85.6	103.7/118.3	107.0/121.2

POWER SUPPLY							
Phase/Voltage/Frequency		1P/220-240V/50Hz	1P/220-240V/50Hz	1P/220-240V/50Hz	3P/380-415V/50Hz	3P/380-415V/50Hz	3P/380-415V/50Hz
Power supply side		Outdoor	Outdoor	Outdoor	Outdoor	Outdoor	Outdoor
Power cable section	mm²	3x1.5	2.5x3	4.0x3	2.5x5	2.5x5	2.5x5
Max. current (D curve)	A	16	20	25	16	16	16
Electrical connections	mm²	4x1.0	4x1.0	4x1.0	4x1.0	4x1.0	4x1.0

PIPE LINE							
Suction pipe diameter	inches	1/2"	5/8"	5/8"	5/8"	5/8"	5/8"
Liquid pipe diameter	inches	1/4"	3/8"	3/8"	3/8"	3/8"	3/8"
Max. length	m	30	50	75	75	75	75
Max. height	m	20	25	30	30	30	30
Refrigerant/GWP		R32/675	R32/675	R32/675	R32/675	R32/675	R32/675
Charge (5 m)	kg	1.15	1.50	2.40	2.40	2.90	3.00
Additional charge	g/m	12	24	24	24	24	24

### MATCHING





DC Inverter  
Cooling only

A<sup>++</sup>

# FDLK

## Low-temperature floor ceiling



RCW25  
included

### + PRODUCT

- RCW25 remote control included
- Minimum temperature setpoint of 12 °C
- Robust and tough: metal structure

### FEATURES

#### TECHNOLOGY



ELECTRONIC EXPANSION VALVE

#### AIR QUALITY



FRESH AIR

#### USER FUNCTIONS



I FEEL



NIGHT MODE



24 H

PROGRAMMABLE  
TIMER



RESTART  
(MEMORY)



REMOTE CONTROL  
LOCK

#### INSTALLER FUNCTIONS



ERROR PART NUMBER  
VIA INDOOR UNIT



AUTO-DIAGNOSTIC



LEFT/RIGHT  
CONDENSATE  
CONNECTION



ALARM OUTPUT



DRY CONTACT  
ON/OFF



TEST MODE  
TECHNICIAN TEST  
MODE

### + «SUSTAINABLE DEVELOPMENT»

- > High energy class A++.

### + «USER»

- > Dedicated solution for low-temperature rooms (wine cellars, preparation rooms, household waste areas, etc.).
- > The indoor unit is more compact and lighter than the previous version, allowing it to be easily built-in even in small spaces.
- > With an optimized air flow rate, the temperature set point can be achieved more quickly.

### + «INSTALLER»

- > Ease of installation.

### + «TECHNOLOGY»

- > Oversized exchangers (no frosting and LP protection).

### OPTIONS

ACCESSORY	PART NUMBER	PICTURE	FUNCTION
Condensate pump Mini Flowwatch MF2	7ACTL0517		• Condensate evacuation from indoor units.

*Dedicated for any low-temperature process rooms*

- > Minimum temperature setpoint 12 °C



## TECHNICAL DATA

FDLK

INDOOR UNIT		FDLK-050N-09M25	FDLK-070N-09M25
Part number		7SP012315	7SP012316
Phase		Single-phase	Single-phase

### COOLING

Rated power (min./max.)	kW	5.30 (2.00-5.60)	7.00 (3.50-8.00)
Pdesignc	kW	5.30	7.10
Rated power input	kW	1.495	2.093
SEER/Energy label		6.1/A++	6.1/A++
Operating limits	°C	-15°/50° Dry bulb	

### INDOOR UNIT

Sound pressure level at 1 m (LS/MS/HS)	dB(A)	36/42/47	36/42/47
Sound level	dB(A)	52	52
Airflow (LS/MS/HS)	m³/h	900/1050/1200	900/1050/1200
Dehumidification	l/h	1.80	2.40
Unit dimensions (WxHxD)	mm	1050x675x235	1050x675x235
Package dimensions (WxHxD)	mm	1130x765x330	1130x765x330
Net weight/Gross weight	kg	26.5/31	26.5/31

OUTDOOR UNIT		YDAK-050R-09M25	YDAK-070R-09M25
Part number		7SP063195	7SP063196
Sound pressure level at 1 m	dB(A)	52	54
Sound level	dB(A)	66	68
Airflow	m³/h	1950	3200
Compressor type		Rotary DCI	Twin Rotary DCI
Unit dimensions (WxHxD)	mm	880x555x345	935x702x382
Package dimensions (WxHxD)	mm	920x600x380	975x770x435
Net weight/Gross weight	kg	32.5/35	48.7/52.6

### POWER SUPPLY

Phase/Voltage/Frequency		1P/230V/50Hz	1P/230V/50Hz
Power supply side		Outdoor	Outdoor
Power cable section	mm²	3x2.5	3x2.5
Max. current (D curve)	A	20	20
Electrical connections	mm²	4x1.5	4x1.5

### PIPE LINE

Suction pipe diameter	inches	1/2"	5/8"
Liquid pipe diameter	inches	1/4"	3/8"
Max. length	m	15	20
Max. height	m	8	10
Refrigerant/GWP		R32/675	R32/675
Charge	kg	1.20	1.45
Additional charge	g/m	12	24

### MATCHING

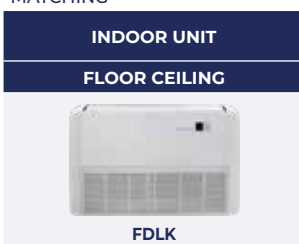

Console  
Floor ceiling  
Floor standing



DC Inverter  
Reversible

# SDMX

## Floor standing



A<sup>++</sup>

### + PRODUCT

- RC19 remote control included (see page 118)
- Long distance air jet
- High airflow (2413 m<sup>3</sup>/h)
- Inverter solution

### FEATURES

#### TECHNOLOGY



ELECTRONIC  
EXPANSION VALVE



GOLDEN FIN  
TREATMENT

#### AIR QUALITY



ANTIBACTERIAL  
FILTER

#### USER FUNCTIONS



TIMER



I FEEL



AUTO RESTART  
(MEMORY)

#### INSTALLER FUNCTIONS



ERROR PART NUMBER  
VIA INDOOR UNIT



RC19  
included

#### + «SUSTAINABLE DEVELOPMENT»

- > Energy label A++ in cooling mode and A+ in heating mode, guaranteeing energy savings.
- > Environmentally friendly R32 refrigerant.

#### + «USER»

- > Solution suitable for large volumes.
- > Controlled by infrared remote control.

#### + «TECHNOLOGY»

- > Room sensor built into the remote control for better comfort ("I Feel" mode).
- > On/off contact included associated with a "room card" or other solution (not supplied) for better control and for energy savings.
- > Alarm contact (synthesis fault) included.
- > Golden Fin treatment on the heat exchangers (external and internal) for protection against corrosion and durability over time.

## TECHNICAL DATA

SDMX

INDOOR UNIT		SDMX-140N-09M35
Part number		7SP101060
Phase		Three-phase
<b>COOLING</b>		
Rated power (min./max.)	kW	14.07 (3.51-15.64)
Rated power input	kW	4.95
SEER/Energy label		6.1/A++
Operating limits	°C	-15°~50°C Dry bulb
<b>HEATING</b>		
Rated power (min./max.)	kW	16.12 (4.92-17.83)
Pdesignh (average climate)	kW	11.10
Pdesignh (warmer climate)	kW	11.00
Rated power input	kW	5.10
SCOP/Energy label (average climate)		4/A+
SCOP/Energy label (warmer climate)		5.17/A+++
Operating limits	°C	-15°~24°C Dry bulb
<b>INDOOR UNIT</b>		
Sound pressure level at 1.5 m	dB(A)	55
Sound level	dB(A)	67
Airflow (LS/MS/HS)	m³/h	2027/2222/2413
Dehumidification	l/h	4.80
Unit dimensions (WxHxD)	mm	629x1935x456
Package dimensions (WxHxD)	mm	750x2055x575
Net weight/Gross weight	kg	59.0/77.0

OUTDOOR UNIT		YDAX-140H-09T35
Part number		7SP063175
Sound pressure level at 1 m	dB(A)	62
Sound level	dB(A)	73
Airflow	m³/h	7500
Compressor type		Rotary
Unit dimensions (WxHxD)	mm	952x1333x415
Package dimensions (WxHxD)	mm	1095x1480x495
Net weight/Gross weight	kg	103.7/118.3

POWER SUPPLY		
Phase/Voltage/Frequency		3P/380-415V/50Hz
Power supply side		Outdoor
Power cable section	mm²	5x2.5
Max. current (D curve)	A	20
Electrical connections	mm²	4x1.5

PIPE LINE		
Suction pipe diameter	inches	5/8"
Liquid pipe diameter	inches	3/8"
Max. length	m	65
Max. height	m	30
<b>Refrigerant/GWP</b>		<b>R32/675</b>
Charge (5m)	kg	2.80

### MATCHING

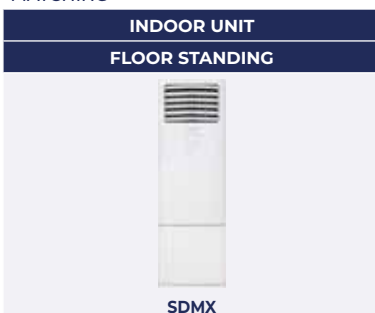





# DUCTED

## Range

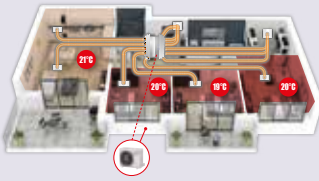

MODEL	REFRIGERANT TYPE	12	18	24	36	48	60	kBTU/h kW
		3.5	5	7	10	14	17	
<p>p.66</p>  <p><b>DDMX</b> <small>NEW</small></p> <p>R32</p> <p><b>MEDIUM-PRESSURE DUCTED</b> <i>Designed to fit into tight false ceiling</i></p>		•	•	•	•	•	•	
<p>p.68</p>  <p><b>WELLZONE</b></p> <p><b>ZONE-BY-ZONE REGULATION</b> <i>Ideal temperature in each room</i></p>							•	



DC Inverter  
Reversible

A<sup>++</sup>

**HYBRID**  
HOUSE by Airwell

# DDMX Ducted medium static pressure



DDMX 035



RCW11  
included



DDMX 050-175



## + PRODUCT

- RCW11 remote control included (see page 120)
- Discreet
- Compact
- Performance
- Wired remote control supplied
- Compatible with YDZC and ZDAA multisplits
- Wellzone compatible

## FEATURES

### TECHNOLOGY



FLEXY MATCH



ELECTRONIC EXPANSION VALVE



GOLDEN FIN TREATMENT

### AIR QUALITY



ANTIBACTERIAL FILTER

### USER FUNCTIONS



PROGRAMMABLE TIMER



I FEEL



NIGHT MODE



AUTO RESTART (MEMORY)

## CERTIFICATION

- AIRWELL participates in the ECP programme for AC1. Check ongoing validity of certificate: [www.eurovent-certification.com](http://www.eurovent-certification.com)



- Models marked \* are not Eurovent certified

## + «SUSTAINABLE DEVELOPMENT»

- > Energy label A++ in cooling mode and A+ in heating mode, guaranteeing energy savings.

## + «USER»

- > Invisible solution that can adapt to all types of interiors.
- > Wide range adapted to your needs.
- > Quiet thanks to its installation in a false ceiling.

## + «INSTALLER»

- > Compact design, ideal for tight spaces.
- > Static pressure (160 Pa) suitable for long duct lengths.
- > Unit with pre-drilled holes for fresh air supply to the room.
- > Maximum piping length up to 75m adapted to complex and remote installation.

## + «TECHNOLOGY»

- > On/off contact included associated with a "room card" or other solution (not supplied) for better control and for energy savings.
- > Alarm contact (synthesis fault) included.
- > Room sensor built into the remote control for better comfort ("I Feel" mode).
- > Condensate pump included for automatic discharge.
- > Golden Fin treatment on the heat exchangers (external and internal) for protection against corrosion and durability over time.
- > Wide operating range of -15° to 50°C in cooling mode and -15° to 24°C in heating mode.

## OPTIONS

ACCESSORY	PART NUMBER	PICTURE	FUNCTION
Wireless controller RC18 (see page 116)	7ACEL1898		• Fan speed mode, On/Off timer, "I Feel" function, technician test mode.
LCAC Wi-Fi accessory	7ACEL1883		• Accessory for remote control via Wi-Fi.
Insulated air duct plenum	7ACVF0136		• 3 ducts DN160. For DDMX 50.
	7ACVF0137		• 3 ducts DN160. For DDMX 70.
	7ACVF0138		• 3 ducts DN160. For DDMX 100.
	7ACVF0139		• 3 ducts DN160. For DDMX 140-175.

## TECHNICAL DATA

DDMX

INDOOR UNIT		DDMX-035N-09M25	DDMX-050N-09M25	DDMX-070N-09M25	DDMX-100N-09M25	DDMX-100N-09M25	DDMX-140N-09M25*	DDMX-175N-09M25*
Part number		7SP033070	7SP033071	7SP033072	7SP033073	7SP033073	7SP033074	7SP033075
Phase		Single-phase	Single-phase	Single-phase	Single-phase	Three-phase	Three-phase	Three-phase

### COOLING

Rated power (min./max.)	kW	3.52 (0.53-3.99)	5.28 (2.55-5.86)	7.03 (3.28-8.16)	10.55 (2.75-11.14)	10.55 (2.73-11.78)	14.07 (3.52-15.53)	15.24 (4.10-17.29)
Pdesignc	kW	3.50	5.40	7.10	10.50	10.60	14.00	15.30
Rated power input	kW	1.05	1.53	2.19	3.95	4.00	4.80	5.25
SEER/Energy label		6.3/A++	6.5/A++	6.2/A++	6.2/A++	6.1/A++	6.1/A++	6.1/A++
Operating limits	°C	-15°-50°C Dry bulb						

### HEATING

Rated power (min./max.)	kW	3.81 (1.00-4.39)	5.57 (2.20-6.15)	7.62 (2.81-8.49)	11.72 (2.78-12.78)	11.72 (2.78-12.84)	16.12 (4.10-18.17)	18.17 (4.40-20.52)
Pdesignh (average climate)	kW	2.70	4.30	5.40	8.40	8.80	8.80	12.50
Pdesignh (warmer climate)	kW	3.40	5.20	6.00	9.80	10.00	11.50	12.80
Rated power input	kW	1.04	1.51	1.90	3.25	3.25	4.50	5.15
SCOP/Energy label (average climate)		4.0/A+	4.0/A+	4.0/A+	4.0/A+	4.0/A+	4.0/A+	4.0/A+
SCOP/Energy label (warmer climate)		5.1/A+++	5.1/A+++	5.1/A+++	5.1/A+++	5.1/A+++	5/A++	5.1/A+++
Operating limits	°C	-15°-24°C Dry bulb						
Power at -7°C	kW	2.98	4.45	6.13	9.11	9.18	12.89	13.27
Power at -10°C	kW	2.60	3.74	5.40	7.60	7.63	10.69	11.92
Power at -15°C	kW	2.08	2.99	4.32	6.08	6.10	8.55	9.54

### INDOOR UNIT

Sound pressure level at 1 m (VL/LS/MS/HS)	dB(A)	23/29/30.5/34.5	26/34/38/41	27/37/42/40	42/46/48/49.5	42/46/48/49.5	42/47/49/50	47/49/52.5
Sound level	dB(A)	58	58	62	61	61	66	66
Airflow (LS/MS/HS)	m³/h	300/480/600	515.2/706/911	825.1/1035/1229	1500/1800/2100	1500/1800/2100	1680/2040/2400	1820/2210/2600
External static pressure (standard/max.)	Pa	25/0-60	25/0-100	25/0-160	37/0-160	37/0-160	50/0-160	50/0-160
Dehumidification	l/h	1.20	1.80	2.40	3.60	3.60	4.80	5.50
Unit dimensions (WxHxD)	mm	700x200x506	880x210x674	1100x249x774	1360x249x774	1360x249x774	1200x300x874	1200x300x874
Package dimensions (WxHxD)	mm	860x285x540	1070x280x725	1305x315x805	1570x300x805	1570x330x805	1405x365x915	1405x365x915
Net weight/Gross weight	kg	17.8/25.2	24.4/30.4	32.3/39.7	40.5/48.9	40.5/48.9	47.6/56.5	47.4/56.8

OUTDOOR UNIT		YDAX-035H-09M25	YDAX-050H-09M25	YDAX-070H-09M25	YDAX-100H-09M25	YDAX-100H-09T35	YDAX-140H-09T35	YDAX-175H-09T35
Part number		7SP063170	7SP063171	7SP063172	7SP063173	7SP063174	7SP063175	7SP063176
Sound pressure level at 1 m	dB(A)	51	54	57	59	59	63	63
Sound level	dB(A)	62	65	68	70	70	74	74
Airflow	m³/h	2200	2100	3500	4000	4000	7500	7500
Compressor type		Rotary	Rotary	Rotary	Rotary	Rotary	Rotary	Rotary
Unit dimensions (WxHxD)	mm	765x555x303	805x554x330	890x673x342	946x810x410	946x810x410	952x1333x415	952x1333x415
Package dimensions (WxHxD)	mm	887x610x337	915x615x370	995x740x398	1090x885x500	1090x885x500	1095x1480x495	1095x1480x495
Net weight/Gross weight	kg	26.6/29.4	32.5/35.3	43.9/46.7	66.9/72.1	75.5/85.6	103.7/118.3	107.0/121.2

### POWER SUPPLY

Phase/Voltage/Frequency		1P/220-240V/50Hz	1P/220-240V/50Hz	1P/220-240V/50Hz	1P/220-240V/50Hz	3P/380-415V/50Hz	3P/380-415V/50Hz	3P/380-415V/50Hz
Power supply side		Outdoor	Outdoor	Outdoor	Outdoor	Outdoor	Outdoor	Outdoor
Power cable section	mm²	3x1.5	3x1.5	3x2.5	3x4.0	5x2.5	5x2.5	5x2.5
Max. current (D curve)	A	10	16	20	25	16	16	16
Shielded electrical connections	mm²	4x1.0	4x1.0	4x1.0	4x1.0	4x1.0	4x1.0	4x1.0

### PIPE LINE

Suction pipe diameter	inches	3/8"	1/2"	5/8"	5/8"	5/8"	5/8"	5/8"
Liquid pipe diameter	inches	1/4"	1/4"	3/8"	3/8"	3/8"	3/8"	3/8"
Max. length	m	25	30	50	75	75	75	75
Max. height	m	10	20	25	30	30	30	30
Refrigerant/GWP		R32/675	R32/675	R32/675	R32/675	R32/675	R32/675	R32/675
Charge (5 m)	kg	0.72	1.15	1.50	2.40	2.40	2.90	3.00
Additional charge	g/m	12	12	24	24	24	24	24

### MATCHING

INDOOR UNIT	COMPATIBLE WITH OUTDOOR UNIT		
	MONOSPLIT	MULTISPLIT	
 DDMX 035-050	 YDAX	 ZDAA	 YDZC
 DDMX 070-100	 YDAX		
 DDMX 140-175	 YDAX		

Ducted

**WELLZONE:**  
*ideal temperature  
in each room*

This solution works with  
the ducted DDMX.

- ▶ Air/air heat pump: **control up to 6 zones** in heating and cooling mode.
- ▶ The air louvers change their position (from 0 to 100%) in accordance with the thermostat (temperature set point) of each room, which **maintains the desired comfort temperature**.
- ▶ Each zone has an **independent remote control** equipped with the “I Feel” system, used to control the ambient temperature and the air louvers.
- ▶ **Invisible** HVAC solution for the whole house.
- ▶ **Cost saving** system (1 single indoor unit).

### OPTION 1: YOUR ALL INCLUSIVE SOLUTION

REFERENCE	DESCRIPTION	COMPATIBILITY	PART NUMBER
1 WELLZONE 3V	• Control up to 3 zones	DDMX 35-50	7ACEL1805
2 WELLZONE 4V	• Control up to 4 zones	DDMX 35-50	7ACEL1806
3 WELLZONE 4V-5S	• Control up to 4 zones with 5 outputs	DDMX 70-175	7ACEL1807
4 WELLZONE 5V	• Control up to 5 zones	DDMX 70-175	7ACEL1808
5 WELLZONE 5V-6S	• Control up to 5 zones with 6 outputs	DDMX 70-175	7ACEL1903
6 WELLZONE 6V	• Control up to 6 zones	DDMX 70-175	7ACEL1809

DESCRIPTION	1	2	3	4	5	6
	WELLZONE 3V	WELLZONE 4V	WELLZONE 4V-5S	WELLZONE 5V	WELLZONE 5V-6S	WELLZONE 6V
QUANTITY	QUANTITY	QUANTITY	QUANTITY	QUANTITY	QUANTITY	QUANTITY
<b>PACK WZ</b>						
Thermostat	3	4	4	5	5	6
Programming timer	1	1	1	1	1	1
Servomotor	3	4	5	5	6	6
Control systems gateway	1	1	1	1	1	1
Supply plenum	1	1	1	1	1	1
Return plenum	1	1	1	1	1	1
ABS plenum grid (400x150 mm)	3	4	5	5	6	6
Double deflection air supply grid in matt white aluminum (400x150 mm)	3	4	5	5	6	6
Steel plenum grid (600x400 mm)	1	1	2	2	2	2
White aluminium return filter holder grid (600x400 mm)	1	1	2	2	2	2
Reducer (250/200 mm)	-	-	1	1	2	2
10m polyester-insulated duct M1 (Ø200 mm)	4	5	7	7	8	8
10m polyester-insulated duct M1 (Ø250 mm)	1	1	2	2	2	2

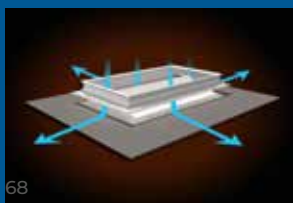

Customize design of air supply grids  
according to interior of house.

**SIMULATION FOR AN INSTALLATION IN 4 ZONES WITH 5 OUTPUTS / WELLZONE 4V-5S**

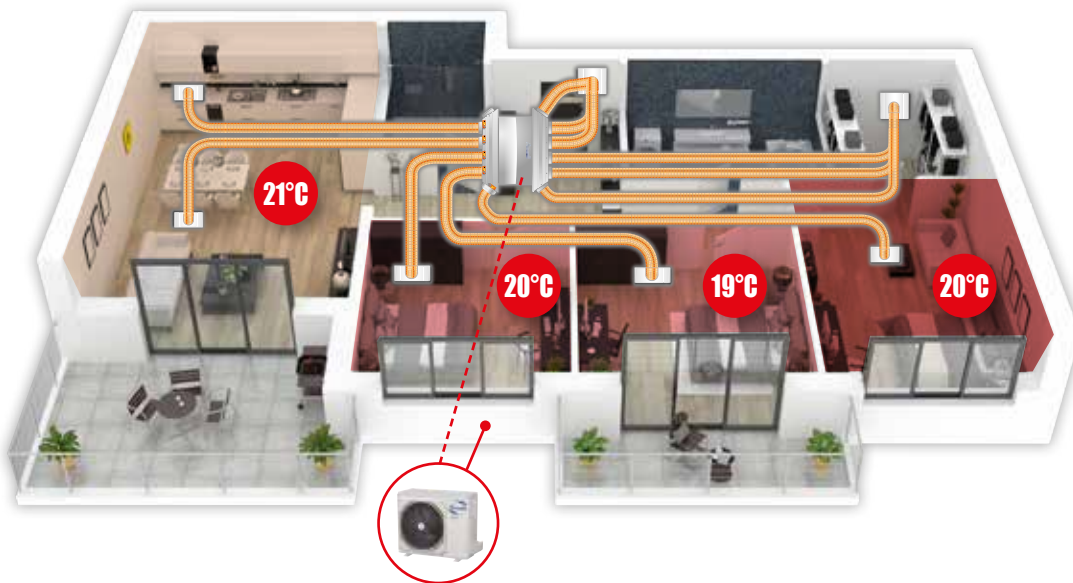

**CONTENTS OF A COMPLETE WELLZONE KIT**



REFERENCE	DUCT DIAMETER (Ø)	DIMENSIONS A x B x C
PLENUM 3S	250 > 200 > 160	1100 x 350 x 411
PLENUM 4S	200 > 160	1100 x 350 x 300
PLENUM 6S	250 & 200 > 160	1621 x 350 x 450

**OPTION 2: YOUR CONTROL SYSTEMS GATEWAY SOLUTION**

► Adjust according to your needs by selecting the Wellzone pack of your choice (see table below).

The most economic solution

**COMPOSITION OF A REGULATION PACK**

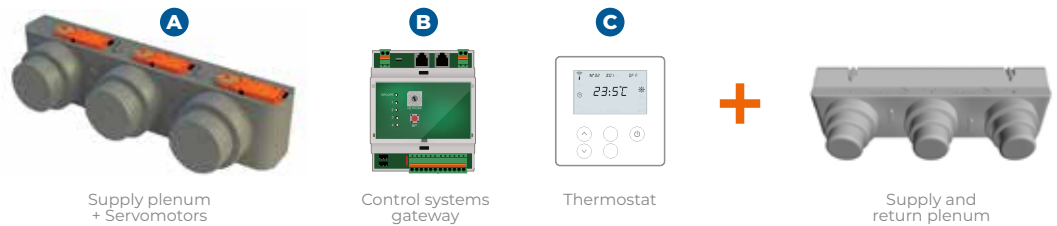

REFERENCE	DESCRIPTION	COMPATIBILITY	PART NUMBER
PACK WZ 3V	A x1 / B x1 / C x3	DDMX 35-50	7ACEL1810
PACK WZ 4V	A x1 / B x1 / C x4	DDMX 35-50	7ACEL1811
PACK WZ 4V-5S	A x1 / B x1 / C x4	DDMX 70-175	7ACEL1812
PACK WZ 5V	A x1 / B x1 / C x5	DDMX 70-175	7ACEL1813
PACK WZ 5V-6S	A x1 / B x1 / C x5	DDMX 70-175	7ACEL1904
PACK WZ 6V	A x1 / B x1 / C x6	DDMX 70-175	7ACEL1814

Don't forget the supply/return plenum in the composition of your Pack:

PLENUM 3S	Supply/return plenum	DDMX 35-50	7ACEL1822
PLENUM 4S	Supply/return plenum	DDMX 35-50	7ACEL1823
PLENUM 6S	Supply/return plenum	DDMX 70-175	7ACEL1824

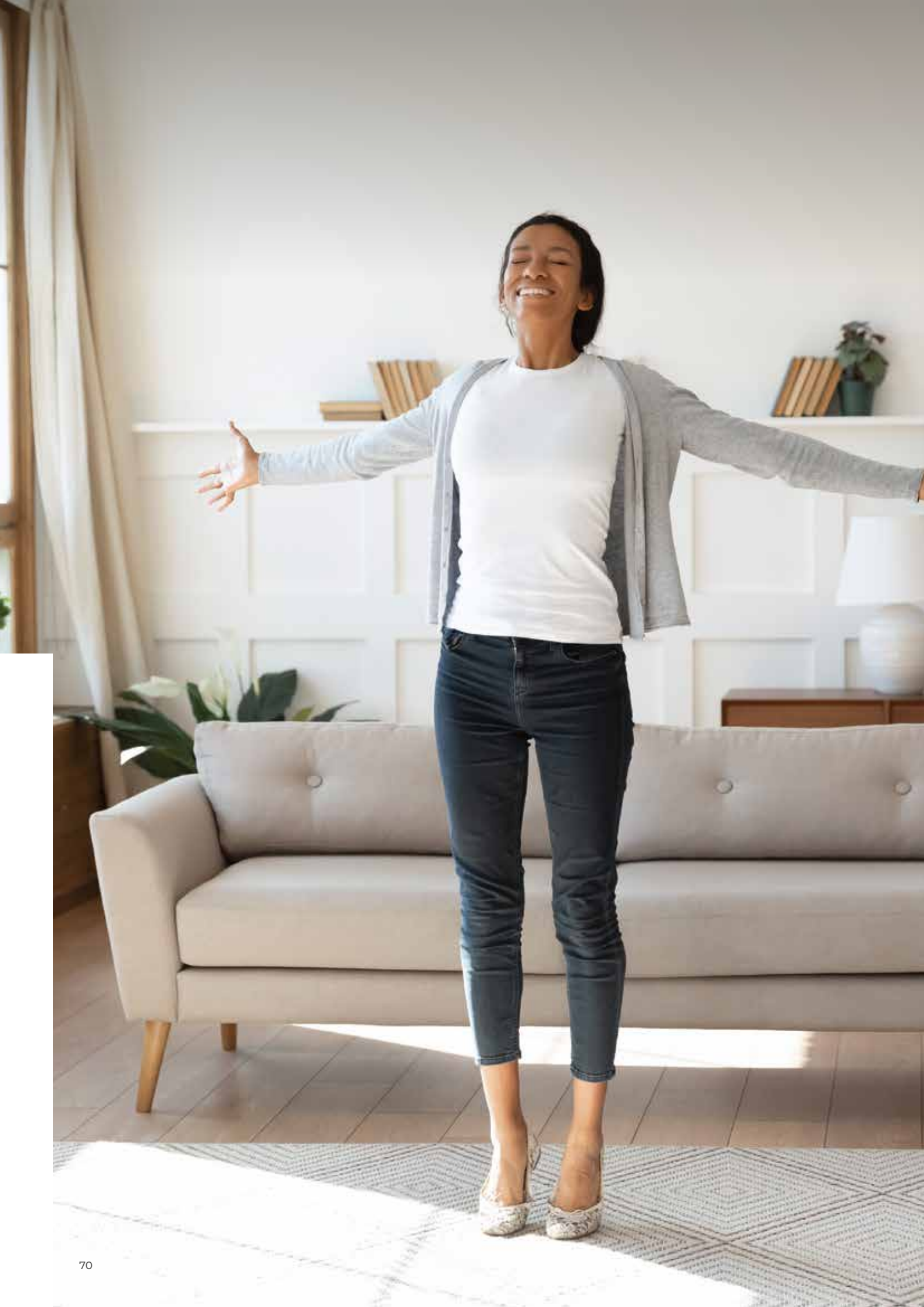

# VENTILATION

## Range

MODEL	REFRIGERANT TYPE	SYSTEM	FUNCTION
 <p>JDAA AIRFLOW</p>	R32	Monoblock	Fan
THERMODYNAMIC DUAL-FLOW CMV			

p.72



Airflow

**HYBRID**  
HOUSE by Airwell

# JDAA AIRFLOW

## Thermodynamic dual-flow CMV



Remote control included

### + PRODUCT

- Remote control included
- Excellent COP
- No refrigerant handling
- Operates using 100% fresh air
- Compact unit

### FEATURES



PROGRAMMABLE  
TIMER



WEEKLY TIMER



REMOTE CONTROL  
LOCK



UNIT ON/OFF OUTPUT

#### + «SUSTAINABLE DEVELOPMENT»

- > High-performance product with COP > 7.

#### + «USER»

- > Allows you to renew the air in the home by heating or cooling fresh air, thanks to a thermodynamic system.
- > Operates using 100% filtered fresh air.

#### + «INSTALLER»

- > Simple to install, thanks to its Monoblock system.
- > This unit is suitable for any type of home.

#### + «TECHNOLOGY»

- > Monoblock system.
- > Inverter technology.



Exhaust air from the house after energy recovery

Exhaust air from the house

100% fresh air from Outdoor

Purified and conditioning fresh air

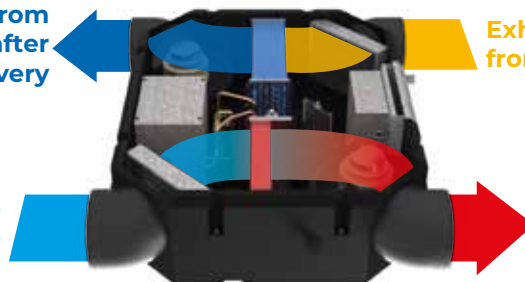



## TECHNICAL DATA

MODEL		JDAA-022R-09M25					
Part number		7MB10001					
Phase		Single-phase					
Airflow	m <sup>3</sup> /h	125	150	210	270	320	
<b>HEATING MODE</b>							
Outdoor air +7°C Air supply 20 °C	Heating capacity	kW	1.42	1.55	1.86	2.05	2.49
	Power input	kW	0.46	0.42	0.45	0.42	0.54
	<b>COP</b>		<b>3.09</b>	<b>3.69</b>	<b>4.13</b>	<b>4.93</b>	<b>4.61</b>
Outdoor air -5°C Air supply 20 °C	Heating capacity	kW	1.97	2.10	2.21	2.37	2.45
	Power input	kW	0.40	0.52	0.47	0.37	0.32
	<b>COP</b>		<b>4.93</b>	<b>4.04</b>	<b>4.70</b>	<b>6.50</b>	<b>7.66</b>
<b>COOLING MODE</b>							
Outdoor air 35°C Air supply 27°C	Cooling capacity	kW	1.57	1.64	1.73	1.92	2.07
	Power input	kW	0.36	0.52	0.53	0.55	0.81
	<b>EER</b>		<b>4.34</b>	<b>3.15</b>	<b>3.26</b>	<b>3.50</b>	<b>2.56</b>
Outdoor air 30°C Air supply 27°C	Cooling capacity	kW	0.92	1.38	1.47	1.72	2.07
	Power input	kW	0.36	0.52	0.48	0.54	0.81
	<b>EER</b>		<b>2.56</b>	<b>2.65</b>	<b>3.06</b>	<b>3.21</b>	<b>2.77</b>
<b>PERFORMANCE</b>							
Static pressure	Rated	Pa	50	50	50	50	50
	Max.	Pa	120	120	120	120	120
Sound power level		dB(A)	47	48	50	54	58
Sound pressure level (l)		dB(A)	34	35	37	41	45
<b>OPERATING LIMITS</b>							
Outdoor temperature	Cooling	°C					16/45
	Heating	°C					-15/28
<b>POWER SUPPLY</b>							
Phase/Voltage/Frequency			1P/230V/50Hz				
Max. current	A		5				
<b>INSTALLATION &amp; OTHERS</b>							
<b>Refrigerant/GWP</b>			<b>R32/675</b>				
Charge	kg		0.30				
Unit dimensions (WxHxD)	mm		1107x290x900				
Package dimensions (WxHxD)	mm		1200x320x100				
Net weight/Gross weight	kg		44/73				

(l) The sound levels refer to the unit at full load, under nominal test conditions.

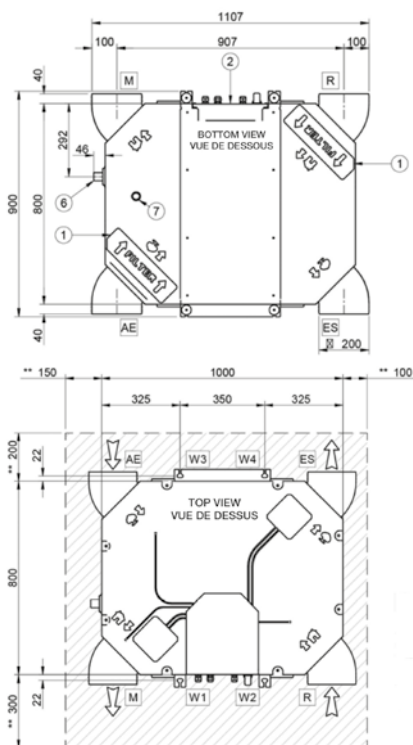

N°	DESCRIPTION
1	• Removable frame for the air filter bottom
2	• Electrical panel
3	• Power input
4	• Keyboard connection
5	• Auxiliary connection
6	• Condensate drain connection
7	• Emergency drain
W	• Mounting brackets
AE	• Fresh air intake
ES	• Air exhaust
M	• Conditioned fresh air
R	• Exhaust air discharge

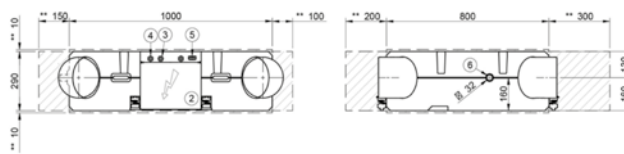



# CASSETTE

## Range



MODEL	REFRIGERANT TYPE	9	12	18	24	36	48	kBTU/h kW
		2.5	3.5	5	7	10	14	
<p>p.76</p>  <p><b>CDMX</b></p> <p><b>N</b> NEW</p> <p><b>CASSETTE</b></p> <p>360° cassette</p>	R32	60x60	60x60	60x60	90x90	90x90	90x90	



DC Inverter  
Reversible

A<sup>++</sup>

# CDMX

## 360° cassette



RC18  
included



CDMX 025N-050N



CDMX 070N-140N

### + PRODUCT

- RC18 remote control included (see page 116)
- Compact design
- 360° airflow
- Compatible with YDZC and ZDAA multisplits

### FEATURES

#### TECHNOLOGY



FLEX MATCH



ELECTRONIC EXPANSION VALVE



MULTIFLOW 360°



GOLDEN FIN TREATMENT

#### AIR QUALITY



ANTIBACTERIAL FILTER



FRESH AIR

#### USER FUNCTIONS



TIMER



I FEEL



NIGHT MODE



REMOTE CONTROL LOCK



RESTART

AUTO RESTART (MEMORY)

#### INSTALLER FUNCTIONS



ERROR PART NUMBER VIA INDOOR UNIT



AUTO-DIAGNOSTIC



CONDENSATE PUMP BUILT-IN



ALARM OUTPUT



DRY CONTACT ON/OFF



HEATING MODE ONLY

### CERTIFICATION

- AIRWELL participates in the ECP programme for ACI. Check ongoing validity of certificate: [www.eurovent-certification.com](http://www.eurovent-certification.com)



### + «SUSTAINABLE DEVELOPMENT»

- > Energy label A++ in cooling mode and A+ in heating mode, guaranteeing energy savings.

### + «USER»

- > Design with a front panel that fits perfectly into false ceiling.
- > 360° air distribution in the room for a uniform temperature.

### + «INSTALLER»

- > Compact size ideal for low ceiling installations.
- > Parameter display on the indoor unit for quick reading.
- > Unit with pre-drilled holes for fresh air supply or blowing into a small room.
- > Maximum piping length up to 75m adapted to complex and remote installation.

### + «TECHNOLOGY»

- > On/off contact included associated with a “room card” or other solution (not supplied) for better control and for energy savings.
- > Alarm contact (synthesis fault) included.
- > Room sensor built into the remote control for better comfort (mode “I Feel”).
- > Condensate pump included for automatic discharge.
- > Electronic expansion valve for better operating precision.
- > Golden Fin treatment on the heat exchangers (external and internal) for protection against corrosion and durability over time.
- > Wide operating range of -15° to 50°C in cooling mode and -15° to 24°C in heating mode.



360° airflow,  
WITH ROUND CORNERS

### OPTIONS

ACCESSORY	PART NUMBER	PICTURE	FUNCTION
Wired remote control RCW11 (see page 120)	7ACEL1774		• Weekly timer, mode, fan speed, On/Off timer, “I Feel” function, temperature.
LCAC Wi-Fi accessory	7ACEL1883		• Accessory for remote control via Wi-Fi. (compatible with CDMX-035N-050N).
	7ACEL1900		• Accessory for remote control via Wi-Fi. (compatible with CDMX-070N-100N-140N).

# TECHNICAL DATA

MULTISPLIT  
CONFIGURATION  
ONLY

INDOOR UNIT		CDMX-025N-09M25	CDMX-035N-09M25	CDMX-050N-09M25	CDMX-070N-09M25	CDMX-100N-09M25	CDMX-100N-09M25	CDMX-140N-09M25*
Part number		7SP042290	7SP042291	7SP042292	7SP042293	7SP042294	7SP042294	7SP042295
Phase		Single-phase	Single-phase	Single-phase	Single-phase	Single-phase	Three-phase	Three-phase
COOLING								
Rated power (min./max.)	kW	2.60 (0.8~3.3)	3.52 (0.85~4.11)	5.28 (2.90~5.59)	7.03 (3.30~7.91)	10.55 (2.70~11.43)	10.55 (2.70~11.43)	14.07 (3.52~15.83)
Pdesignnc	kW		3.50	5.30	7.00	10.50	10.50	14.00
Rated power input	kW		1.01	1.63	2.32	3.95	4.00	4.65
SEER/Energy label			6.6/A++	6.3/A++	6.2/A++	6.7/A++	6.3/A++	6.1/A++
Operating limits	°C	-15°~50°C Dry bulb						
HEATING								
Rated power (min./max.)	kW	2.90 (0.85~3.7)	3.81 (0.47~4.31)	5.57 (2.37~6.10)	7.62 (2.81~8.94)	11.14 (2.78~12.30)	11.14 (2.78~12.66)	16.12 (4.10~17.29)
Pdesignnh (average climate)	kW		2.70	4.20	6.00	8.50	8.00	11.00
Pdesignnh (warmer climate)	kW		3.30	5.40	6.30	10.10	10.10	12.00
Rated power input	kW		1.02	1.54	1.90	3.00	3.00	4.58
SCOP/Energy label (average climate)			4.1/A+	4.0/A+	4.0/A+	4.0/A+	3.9/A	4.0/A+
SCOP/Energy label (warmer climate)			5.1/A+++	4.8/A++	5.1/A+++	5.1/A+++	5.1/A+++	5.0/A++
Operating limits	°C	-15°~24°C Dry bulb						
Power at -7°C	kW		2.95	4.10	5.97	9.13	8.91	12.50
Power at -10°C	kW		2.68	3.66	5.80	7.84	7.60	9.67
Power at -15°C	kW		2.14	2.93	4.64	6.27	6.29	7.74

INDOOR UNIT								
Sound pressure level at 1 m (LS/MS/HS)	dB(A)	31/34/39	34/37/42	39/44/45	42/47/50	46/48/51	46/48/51	48/50/52
Sound level	dB(A)	54	57	59	59	64	64	66
Airflow (LS/MS/HS)	m³/h	400/504/580	389/485/569	479/584/680	992/1118/1247	1300/1530/1700	1300/1530/1700	1600/1750/1900
Dehumidification	l/h	1.20	1.50	2.00	3.00	3.80	3.80	5.50
Unit dimensions (WxHxD)	mm	570x260x570	570x260x570	570x260x570	830x205x830	830x245x830	830x245x830	830x287x830
Package dimensions (WxHxD)	mm	662x317x662	662x317x662	662x317x662	910x250x910	910x290x910	910x290x910	910x330x910
Net weight/Gross weight	kg	14.5/18.8	16.3/20.4	16/22.1	21.6/25.4	27.2/31.2	27.2/31.2	29.3/33.5
PANEL								
Unit dimensions (WxHxD)	mm	647x50x647	647x50x647	647x50x647	950x55x950	950x55x950	950x55x950	950x55x950
Package dimensions (WxHxD)	mm	715x123x715	715x123x715	715x123x715	1035x90x1035	1035x90x1035	1035x90x1035	1035x90x1035
Net weight/Gross weight	kg	2.5/4.5	2.5/4.5	2.5/4.5	6/9	6/9	6/9	6/9
Panel part number		7ACVF0566	7ACVF0566	7ACVF0566	7ACVF0600	7ACVF0600	7ACVF0600	7ACVF0600

OUTDOOR UNIT			YDAX-035H-09M25	YDAX-050H-09M25	YDAX-070H-09M25	YDAX-100H-09M25	YDAX-100H-09T35	YDAX-140H-09T35
Part number		-	7SP063170	7SP063171	7SP063172	7SP063173	7SP063174	7SP063175
Sound pressure level at 1 m	dB(A)		51	54	58	59	59	63
Sound level	dB(A)		62	65	69	70	70	74
Airflow	m³/h		2200	2100	3500	4000	4000	7500
Compressor type			Rotary	Rotary	Rotary	Rotary	Rotary	Rotary
Unit dimensions (WxHxD)	mm		765x555x303	805x554x330	890x673x342	946x810x410	946x810x410	952x1333x415
Package dimensions (WxHxD)	mm		887x610x337	915x615x370	995x740x398	1090x885x500	1090x885x500	1095x1480x495
Net weight/Gross weight	kg		26.6/29	32.5/35.3	43.9/46.7	66.9/72.1	75.5/85.6	103.7/118.3
POWER SUPPLY								
Phase/Voltage/Frequency		1P/220-240V/50Hz	1P/220-240V/50Hz	1P/220-240V/50Hz	1P/220-240V/50Hz	1P/220-240V/50Hz	3P/380-415V/50Hz	3P/380-415V/50Hz
Power supply side			Outdoor	Outdoor	Outdoor	Outdoor	Outdoor	Outdoor
Power cable section	mm²		3x1.5	3x1.5	3x2.5	3x4.0	5x2.5	5x2.5
Max. current (D curve)	A		10	16	20	25	16	16
Shielded electrical connections	mm²	4x1.0	4x1.5	4x1.0	4x1.5	4x1.5	4x1.5	4x1.5
PIPE LINE								
Suction pipe diameter	inches	3/8"	3/8"	1/2"	5/8"	5/8"	5/8"	5/8"
Liquid pipe diameter	inches	1/4"	1/4"	1/4"	3/8"	3/8"	3/8"	3/8"
Max. length	m		25	30	50	75	75	75
Max. height	m		10	20	25	30	30	30
Refrigerant/GWP			R32/675	R32/675	R32/675	R32/675	R32/675	R32/675
Charge (5 m)	kg		0.72	1.15	1.50	2.40	2.40	2.90
Additional charge	g/m		12	12	24	24	24	24

## MATCHING

INDOOR UNIT CASSETTE	COMPATIBLE WITH OUTDOOR UNIT	
	MONOSPLIT	MULTISPLIT
 CDMX 025N		 ZDAA  YDZC
 CDMX 035N & 050N	 YDAX	 ZDAA  YDZC

## MATCHING

INDOOR UNIT CASSETTE	COMPATIBLE WITH OUTDOOR UNIT	
	MONOSPLIT	
 CDMX 070N-100N	 YDAX	
 CDMX 140N	 YDAX	



# MULTISPLIT

## Range



### OUTDOOR UNITS

REFRIGERANT TYPE

KW

p.80



ZDAA



R32

5.3 to 13

ZDAA

Compatible with: HDMB Harmonia and HDLA Aura high wall, FDMX floor ceiling, DDMX ducted and CDMX cassette

p.88



ZDAE



R32

4.1 to 12

ZDAE

Compatible with: HDLE Aura high wall and XDLF console

### INDOOR UNITS

OUT-DOOR UNITS	NB MAX OF IDU	HIGH WALL HDMB HARMONIA WHITE	HIGH WALL HDMB HARMONIA MIRROR	HIGH WALL HDMB HARMONIA GREY	HIGH WALL HDLA AURA	FLOOR CEILING FDMX	DUCTED DDMX	CASSETTE CDMX
ZDAA-2050	2	● Sizes 25/35	● Sizes 35	● Sizes 25/35	● Sizes 25/35	● Sizes 50	● Size 35	● Sizes 25/35
ZDAA-3080	3	● Sizes 25/35/50	● Sizes 35/50	● Sizes 25/35/50	● Sizes 25/35/50	● Sizes 50	● Sizes 35/50	● Sizes 25/35/50
ZDAA-4090	4	● Sizes 25/35/50/70	● Sizes 35/50/70	● Sizes 25/35/50/70	● Sizes 25/35/50/70	● Sizes 50/70	● Sizes 35/50	● Sizes 25/35/50
ZDAA-5130	5	● Sizes 25/35/50/70	● Sizes 35/50/70	● Sizes 25/35/50/70	● Sizes 25/35/50/70	● Sizes 50/70	● Sizes 35/50	● Sizes 25/35/50

OUT-DOOR UNITS	NB. MAX. D'UI	HIGH WALL HDLE AURA	CONSOLE XDLF
ZDAE-2040	2	● Sizes 22/25/35/50	● Sizes 25/35/50
ZDAE-2050	2	● Sizes 22/25/35	● Sizes 25/35
ZDAE-3060	3	● Sizes 22/25/35/50	● Sizes 25/35/50
ZDAE-3070	3	● Sizes 22/25/35/50	● Sizes 25/35/50
ZDAE-4080	4	● Sizes 22/25/35/50	● Sizes 25/35/50
ZDAE-5130	5	● Sizes 22/25/35/50/70	● Sizes 25/35/50



DC Inverter  
Reversible

# ZDAA Multisplit



A<sup>++</sup>

**HYBRID**  
HOUSE by Airwell



## + PRODUCT

- Flexy Match (compatible with most of the range)
- Total piping length up to 80 m
- High capacity compared with market average
- Electronic expansion valve

## FEATURES

### TECHNOLOGY



ELECTRONIC EXPANSION VALVE



GOLDEN FIN TREATMENT

### INSTALLER FUNCTIONS



AUTO-DIAGNOSTIC

## CERTIFICATION

- AIRWELL participates in the ECP programme for AC1. Check ongoing validity of certificate:

[www.eurovent-certification.com](http://www.eurovent-certification.com)



- Models marked \* are not Eurovent certified

## Compatible WITH:

### > High wall HDMB Harmonia



White 25/35/50/70



Mirror 35/50/70



Grey 25/35/50/70

### > High wall HDLA 25/35/50/70



### > Floor ceiling FDMX 50/70



### > Ducted DDMX 35/50/70



### > Cassette CDMX 25/35/50/70



## + «SUSTAINABLE DEVELOPMENT»

- > High energy class A<sup>++</sup> (cooling mode) / A<sup>+</sup> (heating mode).
- > Energy savings (heating mode only, setpoint limits).

## + «USER»

- > A large choice of indoor units.
- > Small footprint with a single outdoor unit.

## + «INSTALLER»

- > Scalable and flexible installation.
- > Long piping.

## + «TECHNOLOGY»

- > High corrosion resistance with the Golden Fin.
- > Refrigerant leak detection.

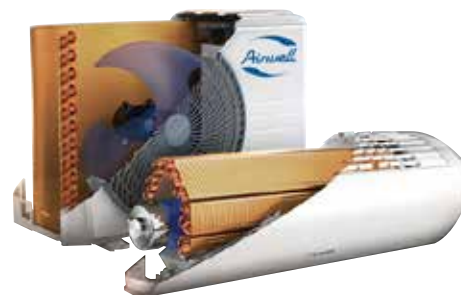

*Longer product service life:*

- > Golden Fin exchanger.
- > Anti-corrosion treatment on PCB.



## TECHNICAL DATA

ZDAA

OUTDOOR UNIT		ZDAA-2050-09M25	ZDAA-3080-09M25	ZDAA-4090-09M25*	ZDAA-5130-09M25*
Part number		7SP091195	7SP091196	7SP091197	7SP091198
Phase		Single-phase	Single-phase	Single-phase	Single-phase

### COOLING

Rated power (min./max.)	kW	5.28 (2.28~5.70)	7.91 (3.08~8.21)	10.55 (2.05-10.55)	12.31 (3.17-12.31)
Pdesignc	kW	5.30	7.90	10.50	12.30
Rated power input	kW	1.63	2.45	3.52	3.81
SEER/Energy label		6.3/A++	6.3/A++	6.3/A++	6.1/A++
Operating limits	°C	-15°/50° Dry bulb			

### HEATING

Rated power (min./max.)	kW	5.57 (2.40~5.74)	8.21 (2.40~8.21)	10.55 (2.34-11.14)	12.31 (3.37-12.31)
Pdesignh (average climate)	kW	4.5	5.7	8.8	9.5
Pdesignh (warmer climate)		5	6	9.8	9.8
Rated power input	kW	1.5	2.21	2.88	3.31
SCOP/Energy label (average climate)		4.0/A+	4.0/A+	4.0/A+	3.8/A
SCOP/Energy label (warmer climate)		5.1/A+++	5.1/A+++	5.1/A+++	5.1/A+++
Power at -7°C	kW	4.03	5.06	7.82	8.42
Operating limits	°C	-15°/24° Dry bulb			

### OUTDOOR UNIT

Sound pressure level at 1 m	dB(A)	54	56	57	56
Sound level	dB(A)	65	68	69	69
Airflow	m³/h	2100	3000	4000	3850
Compressor type		Rotary	Rotary	Rotary	Rotary
Unit dimensions (WxHxD)	mm	805x554x330	890x673x342	946x810x410	946x810x410
Package dimensions (WxHxD)	mm	915x615x370	1030x750x438	1090x875x500	1090x875x500
Net weight/Gross weight	kg	35/38	48/51.8	68.8/75.6	73.3/80.4

### POWER SUPPLY

Phase/Voltage/Frequency		1P/230V/50Hz	1P/230V/50Hz	1P/230V/50Hz	1P/230V/50Hz
Power supply side		Outdoor	Outdoor	Outdoor	Outdoor
Power cable section	mm²	3x1.5	3x2.5	3x2.5	3x4
Max. current (D curve)	A	20	30	30	32
Electrical connections	mm²	2 x (4x1.5)	3x (4x1.5)	4 x (4x1.5)	5 x (4x1.5)

### PIPE LINE

Suction pipe diameter	inches	2x 3/8"	3x3/8"	3x3/8"+1x1/2"	4x3/8"+1x1/2"
Liquid pipe diameter	inches	2x 1/4"	3x1/4"	4x1/4"	5x1/4"
Max. length	m	40	60	80	80
Max. length per circuit	m	25	30	35	35
Max. height between indoor and outdoor unit	Outdoor unit higher than indoor unit	m	15	15	15
	Outdoor unit lower than indoor unit	m	15	15	15
Max. height between indoor units	m	10	10	10	10
<b>Refrigerant/GWP</b>		<b>R32/675</b>	<b>R32/675</b>	<b>R32/675</b>	<b>R32/675</b>
Charge	kg	1.25	1.85	2.1	2.9
Totale length charge	m	15	22.5	30	37.5
Additional charge	g/m	12	12	12	12

Multisplit



High wall  
HDMB Harmonia  
White 25/35/50/70



High wall  
HDMB Harmonia  
Mirror 35/50/70



High wall  
HDMB Harmonia  
Grey 25/35/50/70

INDOOR UNIT - WHITE		HDMB-025N-09M22	HDMB-035N-09M22	HDMB-050N-09M22	HDMB-070N-09M22
Indoor unit part number - White		7SP023235	7SP023236	7SP023237	7SP023238
INDOOR UNIT - GREY		HDMB-025N-09M22-GY	HDMB-035N-09M22-GY	HDMB-050N-09M22-GY	HDMB-070N-09M22-GY
Indoor unit part number - Grey		7SP023244	7SP023245	7SP023246	7SP023247
INDOOR UNIT - MIRROR		HDMB-025N-09M22-MR	HDMB-035N-09M22-MR	HDMB-050N-09M22-MR	HDMB-070N-09M22-MR
Indoor unit part number - Mirror		7SP023240	7SP023241	7SP023242	7SP023243
Phase		Single-phase	Single-phase	Single-phase	Single-phase
Cooling rated power	kW	2.64	3.51	5.27	7.03
Heating rated power	kW	2.92	3.81	5.57	7.33
Sound pressure level at 1 m (VL/LS/MS/HS)	dB(A)	20/24/29/36.5	21/25/33/39.5	22/28/33.5/43	25/30.5/41.5/47
Sound level	dB(A)	55	55	58	63
Airflow (LS/MS/HS)	m³/h	303/362/483	395/477/584	420/500/730	640/830/1020
Dehumidification	l/h	0.90	1.20	1.80	2.40
Unit dimensions (WxHxD)	mm	802x297x189	802x297x189	965x319x215	1080x335x226
Package dimensions (WxHxD)	mm	875x380x285	875x380x285	1045x410x305	1155x320x415
Net weight/Gross weight	kg	8.6/11.3	8.6/11.3	10.9/12.5	13.7/17.5
Panel part number - Silver Grey		7ACTL0551	7ACTL0551	7ACTL0552	7ACTL0553
Panel part number - Champagne Beige		7ACTL0543	7ACTL0543	7ACTL0544	7ACTL0545
Panel part number - Passion Red		7ACTL0547	7ACTL0547	7ACTL0548	7ACTL0549

PIPE LINE

Suction pipe diameter	inches	3/8"	3/8"	1/2"	5/8"
Liquid pipe diameter	inches	1/4"	1/4"	1/4"	3/8"



Mural HDLA  
25/35/50/70

INDOOR UNIT		HDLA-025N-09M25	HDLA-035N-09M25	HDLA-050N-09M25	HDLA-070N-09M25
Part number		7SP023250	7SP023251	7SP023252	7SP023253
Phase		Single-phase	Single-phase	Single-phase	Single-phase
Cooling rated power	kW	2.64	3.52	5.28	7.03
Heating rated power	kW	2.93	3.81	5.57	7.33
Sound pressure level at 1 m (VL/LS/MS/HS)	dB(A)	21/25/32/38.5	21/25/34.5/40.5	20/26/36/42.5	36/40.5/45
Sound level	dB(A)	54	55	56	59
Airflow (LS/MS/HS)	m³/h	325/360/466	314/430/540	540/680/840	662/817/980
Dehumidification	l/h	0.90	1.20	1.80	2.40
Unit dimensions (WxHxD)	mm	805x285x194	805x285x194	957x302x213	1040x327x220
Package dimensions (WxHxD)	mm	870x365x270	870x365x270	1035x385x295	1120x315x405
Net weight/Gross weight	kg	7.6/9.7	7.6/9.8	10.0/13.0	12.3/15.8

PIPE LINE

Suction pipe diameter	inches	3/8"	3/8"	1/2"	5/8"
Liquid pipe diameter	inches	1/4"	1/4"	1/4"	3/8"



Floor ceiling  
FDMX 50/70

INDOOR UNIT		FDMX-050N-09M25	FDMX-070N-09M25
Part number		7SP012300	7SP012301
Phase		Single-phase	Single-phase
Cooling rated power	kW	5.28	7.03
Heating rated power	kW	5.57	7.62
Sound pressure level at 1 m (LS/MS/HS)	dB(A)	37/41/44	43/47/51
Sound level	dB(A)	59	55
Airflow (LS/MS/HS)	m <sup>3</sup> /h	723/839/958	853/1023/1192
Dehumidification	l/h	1.80	2.40
Unit dimensions (WxHxD)	mm	1068x675x235	1068x675x235
Package dimensions (WxHxD)	mm	1145x755x318	1145x755x318
Net weight/Gross weight	kg	28/33.4	28/33.2
PIPE LINE			
Suction pipe diameter	inches	1/2"	5/8"
Liquid pipe diameter	inches	1/4"	3/8"



Ducted DDMX  
35/50/70

INDOOR UNIT		DDMX-035N-09M25	DDMX-050N-09M25	DDMX-070N-09M25
Part number		7SP033070	7SP033071	7SP033072
Phase		Single-phase	Single-phase	Single-phase
Cooling rated power	kW	3.52	5.28	7.03
Heating rated power	kW	3.81	5.57	7.62
Sound pressure level at 1 m (VL/LS/MS/HS)	dB(A)	23/29/30.5/34.5	26/34/38/41	27/37/42/40
Sound level	dB(A)	58	58	62
Airflow (LS/MS/HS)	m <sup>3</sup> /h	300/480/600	515.2/706/911	825.1/1035/1229
External static pressure (standard/max,)	Pa	25/0-60	25/0-100	25/0-160
Dehumidification	l/h	1.20	1.80	2.40
Unit dimensions (WxHxD)	mm	700x200x506	880x210x674	1100x249x774
Package dimensions (WxHxD)	mm	860x285x540	1070x280x725	1305x315x805
Net weight/Gross weight	kg	17.8/21.5	24.4/29.6	32.3/39.1
PIPE LINE				
Suction pipe diameter	inches	3/8"	1/2"	5/8"
Liquid pipe diameter	inches	1/4"	1/4"	3/8"



Cassette CDMX  
25/35/50/70

INDOOR UNIT		CDMX-025N-09M25	CDMX-035N-09M25	CDMX-050N-09M25	CDMX-070N-09M25
Part number		7SP042290	7SP042291	7SP042292	7SP042293
Phase		Single-phase	Single-phase	Single-phase	Single-phase
Cooling rated power	kW	2.60	3.52	5.28	7.03
Heating rated power	kW	2.90	3.81	5.57	7.62
Sound pressure level at 1 m (LS/MS/HS)	dB(A)	31/34/39	34/37/42	39/44/45	42/47/50
Sound level	dB(A)	54	57	59	59
Airflow (LS/MS/HS)	m <sup>3</sup> /h	400/504/580	389/485/569	479/584/680	992/1118/1247
Dehumidification	l/h	1.20	1.50	2.00	3.00
Unit dimensions (WxHxD)	mm	570x260x570	570x260x570	570x260x570	830x205x830
Package dimensions (WxHxD)	mm	662x317x662	662x317x662	662x317x662	910x250x910
Net weight/Gross weight	kg	14.5/17.3	16.3/20.4	16/22.1	21.6/25.4
PANEL					
Unit dimensions (WxHxD)	mm	647x50x647	647x50x647	647x50x647	950x55x950
Package dimensions (WxHxD)	mm	715x123x715	715x123x715	715x123x715	1035x90x1035
Net weight/Gross weight	kg	2.5/4.5	2.5/4.5	2.5/4.5	6/9
Panel part number		7ACVF0566	7ACVF0566	7ACVF0566	7ACVF0600
PIPE LINE					
Suction pipe diameter	inches	3/8"	3/8"	1/2"	5/8"
Liquid pipe diameter	inches	1/4"	1/4"	1/4"	3/8"



Compatible  
WITH:

> High wall HDMB  
Harmonia



White 25/35/50



Mirror 35/50



Grey 25/35/50

> High wall HDLA  
25/35/50



> Floor ceiling  
FDMX 50



> Ducted DDMX  
35/50



> Cassette CDMX  
25/35/50



### ZDAA-2050 MULTISPLIT DUO

Indoor unit combination	COOLING MODE										HEATING MODE									
	Rated power (kW)		Total power (kW)			Total input power (kW)			EER	SEER/ Energy label	Rated power (kW)		Total power (kW)			Total input power (kW)			COP	SCOP/ Energy label
	Unit A	Unit B	Min.	Rated	Max.	Min.	Rated	Max.			Unit A	Unit B	Min.	Rated	Max.	Min.	Rated	Max.		
25	2.50	-	1.43	2.50	3.20	0.35	0.75	0.93	3.35	-	3.00	-	1.56	3.00	3.63	0.32	0.80	1.00	3.75	-
35	3.50	-	1.43	3.50	3.90	0.35	1.08	1.29	3.25	-	3.80	-	1.56	3.80	4.60	0.32	1.00	1.20	3.81	-
50	5.00	-	1.64	5.00	5.51	0.45	1.55	1.89	3.23	-	5.20	-	1.73	5.20	5.79	0.42	1.35	1.88	3.85	-
25+25	2.65	2.65	2.12	5.30	6.41	0.54	1.64	2.05	3.23	6.3/A++	2.78	2.78	2.23	5.57	6.68	0.51	1.50	1.88	3.71	4.00/A+
25+35	2.27	3.03	2.12	5.30	6.41	0.54	1.64	2.05	3.23	6.3/A++	2.39	3.18	2.23	5.57	6.68	0.51	1.50	1.88	3.71	4.00/A+
25+50	1.77	3.53	2.12	5.30	6.47	0.54	1.64	2.05	3.23	6.3/A++	1.86	3.71	2.23	5.57	6.68	0.51	1.50	1.88	3.71	4.00/A+
35+35	2.65	2.65	2.12	5.30	6.41	0.54	1.64	2.05	3.23	6.3/A++	2.79	2.79	2.23	5.57	6.68	0.51	1.50	1.88	3.71	4.00/A+

Based on wall mounted combination

### ZDAA-3080 MULTISPLIT TRIO

Indoor unit combination	COOLING MODE										HEATING MODE											
	Rated power (kW)			Total power (kW)			Total input power (kW)			EER	SEER/ Energy label	Rated power (kW)			Total power (kW)			Total input power (kW)			COP	SCOP/ Energy label
	Unit A	Unit B	Unit C	Min.	Rated	Max.	Min.	Rated	Max.			Unit A	Unit B	Unit C	Min.	Rated	Max.	Min.	Rated	Max.		
25+25	2.65	2.65	-	2.22	5.30	7.12	0.64	1.64	2.45	3.23	5.6/A+	3.00	3.00	-	2.30	6.00	7.39	0.57	1.62	2.20	3.71	3.8/A
25+35	2.57	3.43	-	2.22	6.00	7.52	0.64	1.86	2.57	3.23	5.6/A+	2.70	3.60	-	2.30	6.30	7.80	0.57	1.70	2.31	3.71	3.8/A
25+50	2.27	4.53	-	2.22	6.80	7.91	0.64	2.11	2.69	3.23	5.6/A+	2.33	4.67	-	2.30	7.00	8.21	0.57	1.89	2.42	3.71	3.8/A
35+35	3.15	3.15	-	2.22	6.30	7.68	0.64	1.95	2.65	3.23	5.6/A+	3.25	3.25	-	2.30	6.50	7.96	0.57	1.75	2.38	3.71	3.8/A
35+50	2.72	4.08	-	2.22	6.80	7.91	0.64	2.11	2.69	3.23	5.6/A+	2.80	4.20	-	2.30	7.00	8.21	0.57	1.89	2.42	3.71	3.8/A
25+25+25	2.64	2.64	2.64	2.77	7.91	8.70	0.76	2.45	2.92	3.23	6.3/A++	2.74	2.74	2.74	2.87	8.21	9.85	0.68	2.20	2.75	3.73	4.0/A+
25+25+35	2.37	2.37	3.16	2.77	7.90	8.70	0.76	2.45	2.92	3.23	6.3/A++	2.46	2.46	3.28	2.87	8.20	9.85	0.68	2.20	2.75	3.73	4.0/A+
25+35+35	2.15	2.87	2.87	2.77	7.90	8.70	0.76	2.45	2.92	3.23	6.3/A++	2.24	2.98	2.98	2.87	8.20	9.85	0.68	2.20	2.75	3.73	4.0/A+
35+35+35	2.63	2.63	2.63	2.77	7.90	8.70	0.76	2.45	2.92	3.23	6.3/A++	2.73	2.73	2.73	2.87	8.20	9.85	0.68	2.20	2.75	3.73	4.0/A+

Based on wall mounted combination



Compatible  
WITH:

> High wall HDMB  
Harmonia



White 25/35/50/70



Mirror 35/50/70



Grey 25/35/50/70

> High wall HDLA  
25/35/50/70



> Floor ceiling  
FDMX 50/70



> Ducted DDMX  
35/50/70



> Cassette CDMX  
25/35/50/70



## ZDAA-4090 MULTISPLIT QUATTRO

Indoor unit combination	COOLING MODE												HEATING MODE											
	Rated power (kW)				Total power (kW)			Total input power (kW)			EER	SEER/ Energy label	Rated power (kW)				Total power (kW)			Total input power (kW)			COP	SCOP/ Energy label
	Unit A	Unit B	Unit C	Unit D	Min.	Nom.	Max.	Min.	Nom.	Max.			Unit A	Unit B	Unit C	Unit D	Min.	Nom.	Max.	Min.	Nom.	Max.		
25+25	2.65	2.65	-	-	2.21	5.30	6.83	0.62	1.62	2.44	3.28	5.2/A	3.00	3.00	-	-	2.22	6.00	6.86	0.54	1.62	2.13	3.71	3.4/A
25+35	2.57	3.43	-	-	2.21	6.00	7.35	0.62	1.83	2.60	3.28	5.2/A	3.00	4.00	-	-	2.22	7.00	7.39	0.54	1.89	2.27	3.71	3.4/A
25+55	2.50	5.00	-	-	2.21	7.50	9.45	0.62	2.29	2.93	3.28	5.2/A	2.93	5.87	-	-	2.22	8.80	9.50	0.54	2.37	2.56	3.71	3.4/A
25+70	2.59	6.91	-	-	2.21	9.50	9.98	0.62	2.90	3.12	3.28	5.2/A	2.67	7.13	-	-	2.22	9.80	10.13	0.54	2.64	2.70	3.71	3.4/A
35+35	3.50	3.50	-	-	2.21	7.00	7.88	0.62	2.13	2.76	3.28	5.2/A	3.75	3.75	-	-	2.22	7.50	7.91	0.54	2.02	2.42	3.71	3.4/A
35+50	3.40	5.10	-	-	2.21	8.50	9.98	0.62	2.59	2.93	3.28	5.2/A	3.76	5.64	-	-	2.22	9.40	10.02	0.54	2.53	2.56	3.71	3.4/A
35+70	3.33	6.67	-	-	2.21	10.00	10.50	0.62	3.09	3.19	3.24	5.2/A	3.33	6.67	-	-	2.22	10.00	10.34	0.54	2.70	2.79	3.71	3.4/A
50+50	5.00	5.00	-	-	2.21	10.00	10.50	0.62	3.09	3.25	3.24	5.2/A	5.05	5.05	-	-	2.22	10.10	10.55	0.54	2.72	2.84	3.71	3.5/A
25+25+25	2.50	2.50	2.50	-	2.84	7.50	9.98	0.78	2.31	3.41	3.24	5.8/A+	3.33	3.33	3.33	-	2.85	10.00	10.02	0.68	2.70	2.99	3.71	3.4/A
25+25+35	2.55	2.55	3.40	-	2.84	8.50	10.50	0.78	2.62	3.41	3.24	5.8/A+	3.03	3.03	4.04	-	2.85	10.10	10.55	0.68	2.72	2.99	3.71	3.5/A
25+25+50	2.50	2.50	5.00	-	2.84	10.00	11.55	0.78	3.09	3.58	3.24	5.8/A+	2.68	2.68	5.35	-	2.85	10.70	11.61	0.68	2.88	3.13	3.71	3.6/A
25+25+70	2.14	2.14	5.71	-	2.84	10.00	11.55	0.78	3.09	3.58	3.24	5.8/A+	2.29	2.29	6.11	-	2.85	10.70	11.61	0.68	2.88	3.13	3.71	3.6/A
25+35+35	2.59	3.45	3.45	-	2.84	9.50	11.55	0.78	2.93	3.58	3.24	5.8/A+	2.92	3.89	3.89	-	2.85	10.70	11.61	0.68	2.88	3.13	3.71	3.6/A
25+35+50	2.31	3.08	4.62	-	2.84	10.00	11.55	0.78	3.09	3.58	3.24	5.8/A+	2.47	3.29	4.94	-	2.85	10.70	11.61	0.68	2.88	3.13	3.71	3.6/A
25+35+70	2.00	2.67	5.33	-	2.84	10.00	11.55	0.78	3.09	3.58	3.24	5.8/A+	2.14	2.85	5.71	-	2.85	10.70	11.61	0.68	2.88	3.13	3.71	3.6/A
25+50+50	2.00	4.00	4.00	-	2.84	10.00	11.55	0.78	3.09	3.58	3.24	5.8/A+	2.14	4.28	4.28	-	2.85	10.70	11.61	0.68	2.88	3.13	3.71	3.6/A
35+35+35	3.33	3.33	3.33	-	2.84	10.00	11.55	0.78	3.09	3.58	3.24	5.8/A+	3.57	3.57	3.57	-	2.85	10.70	11.61	0.68	2.88	3.13	3.71	3.6/A
35+35+50	2.86	2.86	4.29	-	2.84	10.00	11.55	0.78	3.09	3.58	3.24	5.8/A+	3.06	3.06	4.59	-	2.85	10.70	11.61	0.68	2.88	3.13	3.71	3.6/A
35+35+70	2.50	2.50	5.00	-	2.84	10.00	11.55	0.78	3.09	3.58	3.24	5.8/A+	2.68	2.68	5.35	-	2.85	10.70	11.61	0.68	2.88	3.13	3.71	3.6/A
35+50+50	2.50	3.75	3.75	-	2.84	10.00	11.55	0.78	3.09	3.58	3.24	5.8/A+	2.68	4.01	4.01	-	2.85	10.70	11.61	0.68	2.88	3.13	3.71	3.6/A
25+25+25+25	2.63	2.63	2.63	2.63	3.68	10.50	13.65	0.88	3.25	3.97	3.23	6.30/A++	2.64	2.64	2.64	2.64	3.69	10.55	12.66	0.77	2.84	3.70	3.71	4.0/A+
25+25+25+35	2.42	2.42	2.42	3.23	3.68	10.50	13.65	0.88	3.25	3.97	3.23	6.30/A++	2.56	2.56	2.56	3.42	3.69	11.10	12.66	0.77	2.99	3.70	3.71	4.0/A+
25+25+25+50	2.10	2.10	2.10	4.20	3.68	10.50	13.65	0.88	3.25	3.97	3.23	6.30/A++	2.22	2.22	2.22	4.44	3.69	11.10	12.66	0.77	2.99	3.70	3.71	4.0/A+
25+25+35+35	2.25	2.25	3.00	3.00	3.68	10.50	13.65	0.88	3.25	3.97	3.23	6.30/A++	2.38	2.38	3.17	3.17	3.69	11.10	12.66	0.77	2.99	3.70	3.71	4.0/A+
25+25+35+50	1.97	1.97	2.63	3.94	3.68	10.50	13.65	0.88	3.25	3.97	3.23	6.30/A++	2.08	2.08	2.78	4.16	3.69	11.10	12.66	0.77	2.99	3.70	3.71	4.0/A+
25+35+35+35	2.10	2.80	2.80	2.80	3.68	10.50	13.65	0.88	3.25	3.97	3.23	6.30/A++	2.22	2.96	2.96	2.96	3.69	11.10	12.66	0.77	2.99	3.70	3.71	4.0/A+
25+35+35+50	1.85	2.47	2.47	3.71	3.68	10.50	13.65	0.88	3.25	3.97	3.23	6.30/A++	1.96	2.61	2.61	3.92	3.69	11.10	12.66	0.77	2.99	3.70	3.71	4.0/A+
35+35+35+35	2.63	2.63	2.63	2.63	3.68	10.50	13.65	0.88	3.25	3.97	3.23	6.30/A++	2.78	2.78	2.78	2.78	3.69	11.10	12.66	0.77	2.99	3.70	3.71	4.0/A+

Based on wall mounted combination



A series of horizontal dotted lines for writing, spanning most of the page width and repeated down to the footer area.



DC Inverter  
Reversible

A<sup>++</sup>

**HYBRID**  
HOUSE by Airwell

# ZDAE Multisplit



► New YDZB designation!



ZDAE Duo/Trio/Quattro



ZDAE Cinco

*Compatible  
WITH:*

> High wall HDLE  
Aura 22/25/35/50/70



> Console XDLF  
25/35/50



## + PRODUCT

- Flexy Match (high wall/console compatible)
- 6 models from 4 to 12 kW and up to 5 indoor units
- Electronic expansion valve

## FEATURES

### TECHNOLOGY



ELECTRONIC  
EXPANSION VALVE

### INSTALLER FUNCTIONS



AUTO-DIAGNOSTIC

## CERTIFICATION

- AIRWELL participates in the ECP programme for AC1. Check ongoing validity of certificate:  
[www.eurovent-certification.com](http://www.eurovent-certification.com)



### + «SUSTAINABLE DEVELOPMENT»

- > High energy class A++ (cooling mode) / A+ (heating mode).

### + «USER»

- > Small footprint with a single outdoor unit.

### + «INSTALLER»

- > The best reliability on the market.

### + «TECHNOLOGY»

- > Extended range: even more power combinations.
- > High resistance to “aggressive” environments (corrosion, voltage, high temperatures).

Available according  
to country, contact us.

2021		2022	
Old designation	Old part number	New designation	New part number
YDZB Multisplit range		ZDAE Multisplit range	
-	-	ZDAE-2040-09M25	7SP091200
AW-YDZB218-H91	7SP091178	ZDAE-2050-09M25	7SP091201
-	-	ZDAE-3060-09M25	7SP091202
AW-YDZB327-H91	7SP091179	ZDAE-3070-09M25	7SP091203
AW-YDZB430-H91	7SP091180	ZDAE-4080-09M25	7SP091204
AW-YDZB542-H91	7SP091190	ZDAE-5130-09M25	7SP091205



## TECHNICAL DATA

ZDAE

OUTDOOR UNIT		ZDAE-2040-09M25	ZDAE-2050-09M25	ZDAE-3060-09M25	ZDAE-3070-09M25	ZDAE-4080-09M25	ZDAE-5130-09M25
Part number		7SP091200	7SP091201	7SP091202	7SP091203	7SP091204	7SP091205
Phase		Single-phase	Single-phase	Single-phase	Single-phase	Single-phase	Single-phase

### COOLING

Rated power (min./max.)	kW	4.10 (2.05-5.00)	5.30 (2.14-5.80)	6.10 (2.20-8.30)	7.10 (2.30-9.20)	8.00 (2.30-11.00)	12.00 (2.60-13.00)
Pdesignc	kW	4.10	5.30	6.10	7.10	8.00	12.00
Rated power input	kW	1.10	1.48	1.48	1.88	2.12	3.45
SEER/Energy label		6.30/A++	6.30/A++	6.60/A++	6.80/A++	6.70/A++	6.10/A++
Operating limits	°C	-15°/50° Dry bulb					

### HEATING

Rated power (min./max.)	kW	4.40 (2.49-5.40)	5.65 (2.58-6.50)	6.50 (3.60-8.50)	8.60 (3.65-9.20)	9.50 (3.65-10.25)	13.00 (2.60-14.50)
Pdesignh (average climate)	kW	3.60	4.10	6.10	6.10	7.20	11.80
Rated power input	kW	0.97	1.25	1.43	2.23	2.20	3.50
SCOP/Energy label (average climate)		4.00/A+	4.00/A+	3.80/A	3.80/A	3.80/A	4.00/A+
Power at -7°C	kW	3.38	3.96	4.77	5.60	7.19	9.46
Operating limits	°C	-15°/24° Dry bulb					

### OUTDOOR UNIT

Sound pressure level at 1 m	dB(A)	50	50	57	57	58	60
Sound level	dB(A)	62	64	68	68	68	70
Airflow	m³/h	2300	2300	3800	3800	3800	5200
Compressor type		Rotary	Rotary	Rotary	Rotary	Rotary	Rotary
Unit dimensions (WxHxD)	mm	745x550x300	745x550x300	889x654x340	889x654x340	889x654x340	1098x1106x440
Package dimensions (WxHxD)	mm	872x620x398	872x620x398	1032x737x456	1032x737x456	1032x737x456	1158x1235x493
Net weight/Gross weight	kg	30/33	32/35	48/52	48/52	51/56	90/98

### POWER SUPPLY

Phase/Voltage/Frequency		1P/230V/50Hz	1P/230V/50Hz	1P/230V/50Hz	1P/230V/50Hz	1P/230V/50Hz	1P/230V/50Hz
Power supply side		Outdoor	Outdoor	Outdoor	Outdoor	Outdoor	Outdoor
Power cable section	mm²	3x1.5	3x1.5	3x2.5	3x2.5	3x2.5	3x4
Max. current (D curve)	A	16	16	25	25	25	25
Electrical connections	mm²	4x0.75	4x0.75	4x0.75	4x0.75	4x0.75	4x0.75

### PIPE LINE

Suction pipe diameter	inches	3/8"	3/8"	3/8"	3/8"	3/8"	3/8"
Liquid pipe diameter	inches	1/4"	1/4"	1/4"	1/4"	1/4"	1/4"
Max. length	m	40	40	60	60	70	75
Max. length per circuit	m	20	20	20	20	20	25
Max. height between indoor and outdoor unit	Outdoor unit higher than indoor unit	m	15	15	15	15	15
	Outdoor unit lower than indoor unit	m	15	15	15	15	15
Max. height between indoor units	m	15	15	15	15	15	8
<b>Refrigerant/GWP</b>		<b>R32/675</b>	<b>R32/675</b>	<b>R32/675</b>	<b>R32/675</b>	<b>R32/675</b>	<b>R32/675</b>
Charge	kg	0.75	0.90	1.60	1.70	1.80	2.75
Totale length charge	m	10	10	30	30	40	40
Additional charge	g/m	20	20	20	20	20	20

Multisplit



High wall HDLE  
Aura 22/25/35/50/70

INDOOR UNIT		HDLE-022N-09M25	HDLE-025N-09M25	HDLE-035N-09M25	HDLE-050N-09M25	HDLE-070N-09M25
Part number		7SP023270	7SP023271	7SP023272	7SP023273	7SP023274
Phase		Single-phase	Single-phase	Single-phase	Single-phase	Single-phase
Cooling rated power	kW	2.20	2.70	3.20	4.60	6.20
Heating rated power	kW	2.40	2.80	3.40	5.20	6.50
Sound pressure level at 1 m (VL/LS/MS/HS)	dB(A)	25/33/36/39	24/34/38/41	24/33/37/41	31/38/42/44	30/37/45/48
Sound level (VL/LS/MS/HS)	dB(A)	37/45/48/55	36/46/50/57	34/45/50/57	41/48/52/54	42/49/57/60
Airflow (VL/LS/MS/HS)	m <sup>3</sup> /h	290/420/470/500	280/400/520/550	280/410/480/590	550/700/800/850	400/600/800/900
Dehumidification	l/h	0.60	1.40	1.40	1.80	1.80
Unit dimensions (WxHxD)	mm	713x270x195	790x275x200	790x275x200	970x300x224	970x300x224
Package dimensions (WxHxD)	mm	776x362x268	866x367x271	866x367x271	1041x383x320	1041x383x320
Net weight/Gross weight	kg	8/9.5	9/11	9/11	13.5/16	13/15.5

#### PIPE LINE

Suction pipe diameter	inches	3/8"	3/8"	3/8"	3/8"	1/2"
Liquid pipe diameter	inches	1/4"	1/4"	1/4"	1/4"	1/4"



Console XDLE  
25/35/50

INDOOR UNIT		XDLF-025N-09M25	XDLF-035N-09M25	XDLF-050N-09M25
Part number		7SP071440	7SP071441	7SP071442
Phase		Single-phase	Single-phase	Single-phase
Cooling rated power	kW	2.70	3.50	5.20
Heating rated power	kW	2.90	3.80	5.33
Sound pressure level at 1 m (VL/LS/MS/HS)	dB(A)	23/26/33/39	25/29/38/44	32/37/43/47
Sound level (VL/LS/MS/HS)	dB(A)	34/38/45/50	35/39/48/54	42/47/53/57
Airflow (VL/LS/MS/HS)	m <sup>3</sup> /h	250/280/410/500	280/360/480/600	320/410/580/700
Dehumidification	l/h	0.80	1.20	1.80
Unit dimensions (WxHxD)	mm	700x600x215	700x600x215	700x600x215
Package dimensions (WxHxD)	mm	788x685x295	788x685x295	788x685x295
Net weight/Gross weight	kg	15.5/18.5	15.5/18.5	15.5/18.5

#### PIPE LINE

Suction pipe diameter	inches	3/8"	3/8"	1/2"
Liquid pipe diameter	inches	1/4"	1/4"	1/4"

*Compatible*

**WITH:**

> High wall HDLE Aura  
22/25/35

> Console XDLEF  
25/35



### ZDAE-2040 MULTISPLIT DUO

Indoor unit combination	COOLING MODE										HEATING MODE									
	Rated power (kW)		Total power (kW)			Total input power (kW)			EER	SEER/ Energy label	Rated power (kW)		Total power (kW)			Total input power (kW)			COP	SCOP/ Energy label
	Unit A	Unit B	Min.	Rated	Max.	Min.	Rated	Max.			Unit A	Unit B	Min.	Rated	Max.	Min.	Rated	Max.		
<b>22+22</b>	2.05	2.05	2.05	4.10	5.00	0.40	1.10	2.25	3.73	6.30/A++	2.20	2.20	2.50	4.40	5.40	0.60	0.97	2.25	4.54	4.00/A+
<b>22+25</b>	1.79	2.31	2.05	4.10	5.00	0.40	1.10	2.25	3.73	6.30/A++	1.93	2.48	2.50	4.40	5.40	0.60	0.97	2.25	4.54	4.00/A+
<b>22+35</b>	1.51	2.59	2.05	4.10	5.00	0.40	1.10	2.25	3.73	6.30/A++	1.62	2.78	2.50	4.40	5.40	0.60	0.97	2.25	4.54	4.00/A+
<b>25+25</b>	2.05	2.05	2.05	4.10	5.00	0.40	1.10	2.25	3.73	6.30/A++	2.20	2.20	2.50	4.40	5.40	0.60	0.97	2.25	4.54	4.00/A+
<b>25+35</b>	1.76	2.34	2.05	4.10	5.00	0.40	1.10	2.25	3.73	6.30/A++	1.89	2.51	2.50	4.40	5.40	0.60	0.97	2.25	4.54	4.00/A+

Based on wall mounted combination

### ZDAE-2050 MULTISPLIT DUO

Indoor unit combination	COOLING MODE										HEATING MODE									
	Rated power (kW)		Total power (kW)			Total input power (kW)			EER	SEER/ Energy label	Rated power (kW)		Total power (kW)			Total input power (kW)			COP	SCOP/ Energy label
	Unit A	Unit B	Min.	Rated	Max.	Min.	Rated	Max.			Unit A	Unit B	Min.	Rated	Max.	Min.	Rated	Max.		
<b>22+22</b>	2.10	2.10	2.15	4.20	4.80	0.40	1.40	2.00	3.00	6.30/A++	2.60	2.60	2.05	5.20	5.62	0.50	1.00	2.20	5.20	4.00/A+
<b>22+25</b>	2.10	2.60	2.15	4.70	5.20	0.40	1.44	2.00	3.26	6.30/A++	2.60	2.80	2.05	5.40	5.83	0.60	1.10	2.20	4.91	4.00/A+
<b>22+35</b>	2.10	3.10	2.15	5.20	5.80	0.40	1.48	2.50	3.51	6.30/A++	1.99	3.41	2.50	5.40	5.90	0.70	1.25	2.50	4.32	4.00/A+
<b>25+25</b>	2.60	2.60	2.15	5.20	5.80	0.40	1.48	2.50	3.58	6.30/A++	2.70	2.70	2.50	5.40	5.90	0.70	1.25	2.50	4.32	4.00/A+
<b>25+35</b>	2.23	2.97	2.15	5.20	5.80	0.50	1.48	2.50	3.51	6.30/A++	2.31	3.09	2.50	5.40	5.90	0.70	1.25	2.50	4.32	4.00/A+
<b>35+35</b>	2.60	2.60	2.15	5.20	5.80	0.50	1.48	2.50	3.51	6.30/A++	2.70	2.70	2.50	5.40	5.90	0.70	1.25	2.50	4.32	4.00/A+

Based on wall mounted combination













# MONOBLOCK

## Range

	MODEL	REFRIGERANT TYPE	10 2.9	12 3.5	kBTU/h kW
p.98	 <p><b>XDA</b></p> <p><b>MONOBLOCK CONSOLE</b> <i>Solution without outdoor unit</i></p>	R32	•		
p.99	 <p><b>WFAE</b></p> <p><b>WINDOW</b> <i>Prefabricated buildings solution</i></p>	R32	•	•	
p.100	 <p><b>MFH</b></p> <p><b>PORTABLE</b> <i>Cooling only</i></p>	R290	•	•	
p.101	 <p><b>MFR</b></p> <p><b>PORTABLE</b> <i>Reversible</i></p>	R290		•	



DC Inverter  
Reversible

# XDA

## Monoblock console

A

Unique  
solution

No outdoor  
unit



### + PRODUCT

- XDA RC remote control included
- Monoblock solution
- Reversible product (cooling/heating)
- No outdoor unit
- No fluid handling



XDA RC included

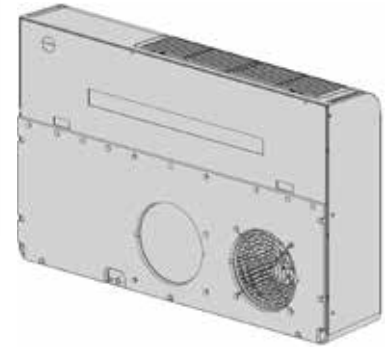

### + «SUSTAINABLE DEVELOPMENT»

> Environmentally friendly R32 refrigerant, low energy consumption.

### + «USER»

> Ideal for modular constructions.

### + «INSTALLER»

> Ease of installation.  
> Plug & Play.

### + «TECHNOLOGY»

> Inverter technology.  
> Monoblock (no outdoor unit).

### TECHNICAL DATA

INDOOR UNIT		AW-XDA009-N91
Part number		7SP071430
Phase		Single-phase
COOLING		
Rated power	kW	2.35 (1.5-3.0)
Rated power input	kW	0.90
EER/Energy label		2.61/A
Operating limits	°C	-10°~43°C Dry bulb
HEATING		
Rated power	kW	2.36 (1.0-2.8)
Rated power input	kW	0.76
COP/Energy label		3.11/A
Operating limits	°C	-15°~24°C Dry bulb
INDOOR UNIT		
Sound pressure level at 1 m (LS/MS/HS)	dB(A)	29/46/48
Sound level	dB(A)	56
Airflow	m³/h	480
Dehumidification	l/h	0.04
Duct diameter	mm	2x200
Unit dimensions (WxHxD)	mm	965x615x200
Package dimensions (WxHxD)	mm	765x1030x280
Net weight/Gross weight	kg	36.2/40.2
POWER SUPPLY		
Phase/Voltage/Frequency		1P/220-240V/50Hz
Power cable section	mm²	3x2.5
Max. current (D curve)	A	10
PIPE LINE		
Refrigerant/GWP		R32/675
Charge	kg	0.39

# WFAE

## Window



WFAE RC included

### ⊕ «SUSTAINABLE DEVELOPMENT»

> Environmentally friendly R32 refrigerant, low energy consumption.

### ⊕ «USER»

> Ideal for modular constructions.

### ⊕ «INSTALLER»

> Ease of installation.

### ⊕ «TECHNOLOGY»

> Inverter technology.

## TECHNICAL DATA

INDOOR UNIT		WFAE-025C-09M25	WFAE-035C-09M25
Part number		7MB050001	7MB050002
Phase		Single-phase	Single-phase
<b>COOLING</b>			
Rated power	kW	2.75	3.70
Pdesignc	kW	2.75	3.70
Rated power input	kW	0.81	1.09
SEER/Energy label		5.10/A	5.10/A
Operating limits	°C	18°/43° Dry bulb	
<b>INDOOR UNIT</b>			
Sound pressure level at 1 m (LS/MS/HS)	dB(A)	45/47/49	45/47/49
Airflow (LS/MS/HS)	m³/h	310/350/380	400/450/490
Dehumidification	l/h	1.00	1.20
Compressor type		Rotary	Rotary
Unit dimensions (WxHxD)	mm	560x375x710	660x428x700
Package dimensions (WxHxD)	mm	623x425x806	739x515x793
Net weight/Gross weight	kg	34/36.7	46/50
<b>POWER SUPPLY</b>			
Phase/Voltage/Frequency		1P/230V/50Hz	1P/230V/50Hz
Power supply side		Indoor	Indoor
Power cable section	mm²	3x1.0	3x1.5
Max. current (D curve)	A	10	10
<b>PIPE LINE</b>			
Refrigerant/GWP		R32/675	R32/675
Charge	kg	0.51	0.63

DC Inverter  
Cooling only



Unique  
solution

A

## ⊕ PRODUCT

- WFAE RC remote control included
- Monoblock solution
- No fluid handling

## FEATURES

### TECHNOLOGY



NIGHT MODE



RESTART  
(MEMORY)

### INSTALLER FUNCTIONS



AUTO-DIAGNOSTIC

Monoblock



Fixed speed  
Cooling only

# MFH Portable

A<sup>+</sup>



RC08C  
included

## + PRODUCT

- RC08C remote control included (see page 112)
- Monoblock solution
- No fluid handling

## FEATURES

### TECHNOLOGY



ANTIBACTERIAL  
FILTER



AUTO  
CLEAN/DRY

### USER FUNCTIONS



I FEEL



NIGHT  
MODE



24 H  
PROGRAMMABLE  
TIMER



RESTART  
(MEMORY)



REMOTE CONTROL  
LOCK

### INSTALLER FUNCTIONS



AUTO-DIAGNOSTIC

## + «SUSTAINABLE DEVELOPMENT»

- > Environmentally friendly R290 refrigerant.

## + «USER»

- > Easy to move thanks to its castors and handles.
- > Easy reading thanks to its digital display on the control panel.
- > Remotely controllable with the RC unit.
- > High comfort thanks to its cooling capacity.

## + «TECHNOLOGY»

- > Caulking kit included.
- > Condensate evacuation by evaporation.

## TECHNICAL DATA

INDOOR UNIT		AW-MFH010-C41	AW-MFH012-C41
Part number		7MB021060	7MB021061
Phase		Single-phase	Single-phase
<b>COOLING</b>			
Rated power	kW	2.93	3.52
Rated power input	kW	0.945	1.357
Courant	A	4.50	5.90
EER/Energy label		3.10/A+	2.60/A
Operating limits	°C	17°/35° Dry bulb	
<b>INDOOR UNIT</b>			
Type		Monoblock	Monoblock
Sound pressure level at 1 m (LS/MS/HS)	dB(A)	50/51/52	50/51/52
Sound level	dB(A)	62	63
Airflow (LS/MS/HS)	m <sup>3</sup> /h	355/370/420	355/370/420
Diameter flexible emission duct	mm	150	
Length range of heat emission duct	m	0.50 - 1.50	
Dehumidification	l/h	1.60	1.80
Unit dimensions (WxHxD)	mm	467x765x397	467x765x397
Package dimensions (WxHxD)	mm	515x890x440	515x890x440
Net weight/Gross weight	kg	31.8/35.7	33/36.5
<b>POWER SUPPLY</b>			
Phase/Voltage/Frequency		1P/230V/50Hz	1P/230V/50Hz
<b>PIPE LINE</b>			
Refrigerant/GWP		R290/20	R290/20
Charge	kg	0.21	0.22

\*Min. pack 8 pcs.

# MFR

## Portable



RC08C included

Confort optimal:  
reversible solution

### + «SUSTAINABLE DEVELOPMENT»

> Environmentally friendly R290 refrigerant.

### + «USER»

> Easy to move thanks to its castors and handles.  
> Easy to read with its digital display.  
> Remotely controllable with the RC unit.

### + «TECHNOLOGY»

> Caulking kit included.  
> Condensate evacuation by evaporation.

## TECHNICAL DATA

INDOOR UNIT		AW-MFR012-H41
Part number		7MB021062
Phase		Single-phase
COOLING		
Rated power	kW	3.52
Rated power input	kW	1.357
Courant	A	5.90
EER/Energy label		2.60/A
Operating limits	°C	17°/35° Dry bulb
HEATING		
Rated power	kW	2.93
Rated power input	kW	1.045
Courant	A	5
COP/Energy label		2.8/A
Operating limits	°C	5°/30° Dry bulb
INDOOR UNIT		
Type		Monoblock
Sound pressure level at 1 m (LS/MS/HS)	dB(A)	54/54/55
Sound level	dB(A)	63
Airflow (LS/MS/HS)	m³/h	355/370/420
Diameter flexible emission duct	mm	150
Length range of heat emission duct	m	0.50-1.50
Dehumidification	l/h	1.80
Unit dimensions (WxHxD)	mm	467x765x397
Package dimensions (WxHxD)	mm	515x890x440
Net weight/Gross weight	kg	33/36.5
POWER SUPPLY		
Phase/Voltage/Frequency		1P/230V/50Hz
PIPE LINE		
Refrigerant/GWP		R290/20
Charge	kg	0.22

\*Min. pack 8 pcs.

Fixed speed  
Reversible

R290

A

## + PRODUCT

- RC08C remote control included (see page 112)
- Monoblock solution
- No fluid handling

## FEATURES

### TECHNOLOGY



ANTIBACTERIAL FILTER



AUTO CLEAN/DRY

### USER FUNCTIONS



I FEEL



NIGHT MODE



24 H PROGRAMMABLE TIMER



RESTART (MEMORY)



REMOTE CONTROL LOCK

### INSTALLER FUNCTIONS





AUTO-DIAGNOSTIC



# WATER-COOLED

## Range

MODEL	REFRIGERANT TYPE	5	9	12	17	21	31	51	71	101	kBTU/h kW
		2	2,5	3,5	4,1	4,5	8	10	17	25	
<p>p.104</p>  <p><b>XDOW</b></p> <p>R410A</p> <p><b>WATER-COOLED CONSOLE</b></p> <p><i>Reversible Monoblock</i></p>			•	•							
<p>p.106</p>  <p><b>DFMO</b></p> <p>R410A</p> <p><b>WATER-LOOP HEAT PUMP</b></p> <p><i>Ideal for stores</i></p>	•	•		•	•	•	•	•	•	•	



DC Inverter  
Reversible

A<sup>++</sup>

Unique  
solution

+ PRODUCT

- Solution without outdoor unit
- Monoblock
- Simple design
- Quiet (25 dB)

# XDOW

## Water-cooled console



Optimal comfort:  
reversible solution

+ «SUSTAINABLE DEVELOPMENT»

- > Reduced water consumption thanks to the built-in modulating valve.

+ «USER»

- > Compact.
- > Quiet.
- > Ideal solution for historic buildings (Monoblock).

+ «INSTALLER»

- > Plug & Play: hydraulic connection only.

+ «TECHNOLOGY»

- > Compatible with water-loop and public water supply.

TECHNICAL DATA

INDOOR UNIT		XDOW-025R-01M25	XDOW-035R-01M25
Part number		7MB070001	7MB070002
Phase		Single-phase	Single-phase
COOLING			
Rated power (1)	kW	2.50	3.50
Pdesignc	kW	2.30	3.20
Rated power input	kW	0.38	0.76
EER/Energy label		4.08/A++	4.05/A++
Operating limits	°C	18°/35° Dry bulb	
Maximum water temperature	°C	40°C	
HEATING			
Rated power (2)	kW	2.70	3.80
Pdesignh	kW	2.50	3.40
Rated power input	kW	0.71	1.09
COP/Energy label		4.33/A++	4.31/A++
Operating limits	°C	5°/27° Dry bulb	
Minimum water temperature	°C	7°C	
INDOOR UNIT			
Sound pressure level at 2 m	dB(A)	25	27
Sound level (LS/MS/HS)	dB(A)	41/46/52	43/48/54
Airflow (LS/MS/HS)	m <sup>3</sup> /h	250/310/385	310/410/435
Recycled water flow	l/h	430	600
Wastewater flow (15°C)	l/h	107	150
Dehumidification	l/h	1.10	1.30
Compressor type		Rotary DCI	Rotary DCI
Unit dimensions (WxHxD)	mm	1030x555x165	1030x555x165
Package dimensions (WxHxD)	mm	1100x660x260	1100x660x260
Net weight/Gross weight	kg	48.5/50.5	49.5/51.5
POWER SUPPLY			
Phase/Voltage/Frequency		1P/220-240V/50Hz	1P/220-240V/50Hz
Power supply side		Indoor	Indoor
Power cable section	mm <sup>2</sup>	3x1.5	3x1.5
Max. current (D curve)	A	6	6
PIPE LINE			
Refrigerant/GWP		R410A/2088	R410A/2088
Charge	kg	0.65	0.65

(1) Conditions: Dry bulb 27°C - Wet bulb 19°C - Water at 30°C ΔT 5K.

(2) Conditions: Dry bulb 20°C - Wet bulb 15°C - Water at 15°C ΔT 5K.



Table with 4 columns: Name, Price, and other details. The table contains approximately 32 rows of data, including entries for various models like 'Water-cooled', 'Airwell', and 'S-Series'.



Fixed speed  
Reversible

# DFMO 22 TO 41

## Water-loop heat pump



Remote control  
included

### + PRODUCT

- Remote control included (see page 124)
- Solution without outdoor unit
- Monoblock
- Compact design
- Wide range
- Thermostat included (ref. 7ACEL1880)

### FEATURES

#### TECHNOLOGY



- (1) Ambient air at 27°C DB/19°C WB. Exchanger water inlet/outlet temperature 30°C/35°C.  
 (2) Ambient air at 20°C DB. Exchanger water inlet temperature 20°C. The exchanger water outlet temperature is obtained as a function of the cooling water flow rate.  
 (3) Ambient air at 20°C DB. Exchanger water inlet temperature 15°C. The exchanger water outlet temperature is obtained as a function of the cooling water flow rate.  
 (4) Water flow rate calculated based on the cooling performance.  
 (5) Data calculated according to EN14825: 2016.

### + «SUSTAINABLE DEVELOPMENT»

> High efficiency.

### + «USER»

> Fire classification: M0 (ERP compatible).

### + «INSTALLER»

> Alarm output for fault reporting.

### + «TECHNOLOGY»

> Built-in temperature sensors for optimized consumption.

### TECHNICAL DATA

INDOOR UNIT		DFMO-022N-01M25	DFMO-031N-01M25	DFMO-041N-01M25
Part number		7MB030001	7MB030002	7MB030003
Phase		Single-phase	Single-phase	Single-phase
COOLING				
Rated power (1)	kW	2.26	3.16	4.16
Rated sensitive power	kW	1.91	2.75	3.50
Totale power input	kW	0.54	0.74	0.92
EER		4.22	4.28	4.51
HEATING - AIR AT 20 °C - WATER AT 20 °C				
Rated power (2)	kW	2.76	3.85	4.92
Totale power input	kW	0.55	0.77	1.06
COP		4.99	4.97	4.66
HEATING - AIR AT 20 °C - WATER AT 15 °C				
Rated power (3)	kW	2.46	3.33	4.42
Totale power input	kW	0.55	0.73	1.02
COP		4.42	4.47	4.30
INDOOR UNIT				
Sound pressure level at 1 m	dB(A)	33	34	35
Number of compressors	nb	1	1	1
Compressor type			Rotary	
Airflow	m <sup>3</sup> /h	533	612	800
Fan type			Centrifugal	
Number of fans	nb	1	1	1
External static pressure	Pa	40 (0-80)	40 (0-80)	40 (0-80)
Water inlet flow (4)	l/s	0.13	0.18	0.24
Unit dimensions (WxHxD)	mm	1034x361x513	1034x361x513	1034x386x513
Net weight/Gross weight	kg	71/81	74/84	82/92
POWER SUPPLY				
Phase/Voltage/Frequency		1P/230V/50Hz	1P/230V/50Hz	1P/230V/50Hz
ERP DATA (5)				
SEER		3.75	3.90	4.18
SCOP		3.41	3.63	4.05
PIPE LINE				
Refrigerant/GWP		R410A/2088	R410A/2088	R410A/2088
Charge	kg	0.47	0.64	1.30

### OPTIONS

#### ACCESSORY

Modbus DFMO 22 to 41  
 Modulating valve DFMO 22 to 41

#### PART NUMBER

7ACEL1881  
 7ACFH0850

# DFMO 45 TO 250

## Water-loop heat pump



Remote control included

Fixed speed  
Reversible



### ⊕ «SUSTAINABLE DEVELOPMENT»

> High efficiency.

### ⊕ «USER»

> Fire classification: M0 (ERP compatible).

### ⊕ «INSTALLER»

> Alarm output for fault reporting.

### ⊕ «TECHNOLOGY»

> Built-in temperature sensors for optimized consumption.

### + PRODUCT

- Remote control included (see page 124)
- Solution without outdoor unit
- Monoblock
- Compact design
- Wide range
- Thermostat included (ref. 7ACEL1880)

### TECHNICAL DATA

INDOOR UNIT		DFMO-045N-01M25	DFMO-080N-01M25	DFMO-100N-01M25	DFMO-170N-01T35	DFMO-250N-01M25
Part number		7MB030004	7MB030005	7MB030006	7MB030007	7MB030008
Phase		Single-phase	Single-phase	Single-phase	Three-phase	Three-phase
<b>COOLING</b>						
Rated power	kW	4.56	8.08	10.60	16.90	25.00
Rated sensitive power	kW	3.74	6.44	8.84	13.90	20.00
Totale power input	kW	1.30	2.07	3.04	4.15	5.85
EER		3.52	3.90	3.53	4.07	4.27
<b>HEATING</b>						
Rated power	kW	7.55	10.30	14.40	23.10	33.20
Totale power input	kW	1.75	2.39	3.35	5.23	7.21
COP		4.30	4.31	4.30	4.41	4.60
<b>INDOOR UNIT</b>						
Sound pressure level at 1m (3)	dB(A)	42	42	44	45	45
Number of compressors	nb	1	1	1	1	1
Compressor type		Rotary	Rotary	Rotary	Scroll	Scroll
Airflow	m <sup>3</sup> /h	1000	1500	2800	3800	4900
Fan type		Centrifugal				
Number of fans	nb	1	1	1	1	1
External static pressure (4)	Pa	250	270	290	310	220
Water inlet flow	l/s	0.27	0.47	0.64	1.00	1.47
Unit dimensions (WxHxD)	mm	962x490x692	962x490x692	1167x590x802	1167x590x802	1467x705x927
Net weight/Gross weight	kg	98/102	103/107	138/143	151/156	200/225
<b>POWER SUPPLY</b>						
Phase/Voltage/Frequency		1P/230V/50Hz	1P/230V/50Hz	1P/230V/50Hz	3P/400V/50Hz/N	3P/400V/50Hz/N
<b>ERP DATA (5)</b>						
SEER		3.28	3.93	3.57	4.23	4.47
SCOP		3.81	3.82	3.81	3.91	4.08
<b>PIPE LINE</b>						
Refrigerant/GWP		R410A/2088				
Charge	kg	0.70	0.95	1.10	1.30	3.20

### OPTIONS

#### ACCESSORY

Modulating valve DFMO 45-170  
Modulating valve DFMO 250

#### PART NUMBER

7ACFH0851  
7ACFH0852







- (1) Ambient air at 27°C DB/19°C WB. Exchanger water inlet/outlet temperature 30°C/35°C.
- (2) Ambient air at 20°C DB. Exchanger water inlet temperature 20°C. The exchanger water outlet temperature is obtained as a function of the cooling water flow rate.
- (3) Ambient air at 20°C DB. Exchanger water inlet temperature 15°C. The exchanger water outlet temperature is obtained as a function of the cooling water flow rate.
- (4) Water flow rate calculated based on the cooling performance.
- (5) Data calculated according to EN14825: 2016.



# CONTROL SYSTEMS

## Range

	MODEL	WIRELESS CONTROLLER	WIRED REMOTE CONTROL
p.110	COMPATIBILITY TABLES		
p.111	FUNCTION TABLES		
p.112	 RC08C	•	
p.114	 RC08A	•	
p.116	 RC18	•	
p.118	 RC19	•	
p.120	 RCW11		•
p.122	 RCW27		•
p.124	 Remote control for DFMO		•

MODEL	INFRARED REMOTE CONTROL				WIRED REMOTE CONTROL				
REFERENCE	RC08C	RC08A	RC18	RC19	RCW11	RCW22	RCW25	RCW27	PASSERELLE GTC
Part number	7ACEL1740	7ACEL1791	7ACEL1898	7ACEL1899	7ACEL1774	7ACEL1778	7ACEL1832	7ACEL1874	7ACEL1708
Picture									
<b>HIGH WALL</b>									
HDMB Harmonia	●					●			
HDLE Aura		●						●	
HDLA Aura	●								
<b>CONSOLE, FLOOR CEILING &amp; FLOOR STANDING</b>									
XDLF		●						●	
FDMX			●		●				●
FDLK							●		
SDMX				●					
<b>DUCTED</b>									
DDMX			●		●				●
<b>CASSETTE</b>									
CDMX			●		●				●
<b>MONOBLOCK</b>									
MFH MFR	●								
WFAE	●								

# FUNCTION TABLES

MODEL	INFRARED REMOTE CONTROL				WIRED REMOTE CONTROL		
REFERENCE	RC08C	RC08A	RC18	RC19	RCW11	RCW25	RCW27
Part number	7ACEL1740	7ACEL1791	7ACEL1898	7ACEL1899	7ACEL1774	7ACEL1832	7ACEL1874
Picture							
<b>USER FUNCTIONS</b>							
On/Off timer	●	●	●	●	●	●	●
Weekly timer					●		●
Silent mode/low speed fan	●	●	●	●	●	●	
"I Feel" function	●	●	●	●	●		●
Clean-up function	●	●	●	●			
Night mode (economy mode)	●	●	●	●			●
Remote locking	●	●	●	●	●	●	●
Turbo mode	●	●	●	●			●
Low battery	●	●	●	●	●		
No frost mode	●	●	●	●			●
<b>INSTALLER FUNCTIONS</b>							
Technician test mode	●	●	●	●			
Group control							●
Compensation temperature	●	●	●	●		●	
Heating mode only	●	●	●	●			
Priority mode definition (multisplit)	●	●					
Parameter display function (temperature, expansion valve opening, compressor...)	●	●	●	●			
Operating fault display					●	●	●

● Standard remote

● Optional remote

# RC08C

Part number: 7ACEL1740



## COMPATIBLE PRODUCTS

- HDMB Harmonia
- HDLA Aura
- MFH
- MFR
- WFAE

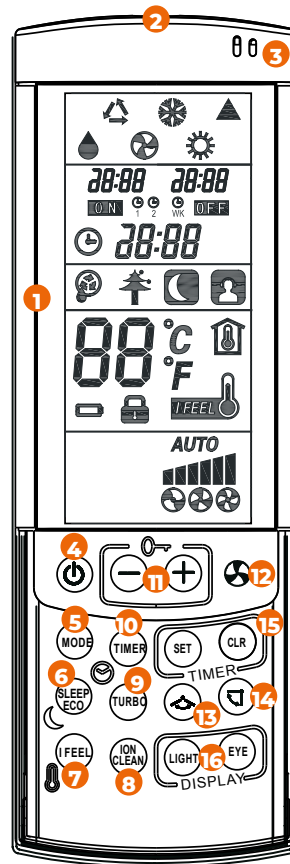

## 1 DISPLAY

Information is displayed when the remote control is on.		
Operating mode		• Automatic
		• Heating
		• Cooling
		• Ventilation only
		• Dehumidify (drying mode)
		• Send data to the air conditioner receiver
		• Clock (hours and minutes)
		• "Time On" function configured and activated
		• "Time Off" function configured and activated
		• Programming repeat function
		• Sleep operating mode
		• Quiet mode
		• Cleaning mode
		• Ionizer /E.S.F. mode
		• Selects or indicates the room temperature
	Description of low battery detection	
Fan speed indication		
		• Medium speed
		• High speed
		• Fan auto speed



## 2 ▶ TRANSMITTER

- When you press the buttons of the remote control unit, the ▲ symbol appears on the display to transmit the setting changes to the air conditioner receiver.

## 3 ▶ SENSOR







- The air temperature sensor inside the remote control unit measures the room temperature.

## 4 ▶ ON/OFF BUTTON

- This button turns the air conditioner ON and OFF.

## 5 ▶ MODE SELECTOR BUTTON

Press this button to change the mode.

	• <b>Automatic.</b> When this mode is selected, the air conditioner calculates the difference between the thermostat setting and the room temperature and automatically switches to "cooling" or "heating" mode.
	• <b>Heating.</b> The air conditioner heats the ambient air.
	• <b>Cooling.</b> The air conditioner cools the room.
	• <b>Ventilation only.</b> The air conditioner circulates the air.
	• <b>Dehumidify (dry mode).</b> The air conditioner reduces the humidity of the air in the room.
	• <b>Cool / Dry / Heat</b>

## 6 ▶ SLEEP/ECO BUTTON

This button has 2 functions:

- **SLEEP function** (short press)
  - **ECONOMY function** (long press)
- For more details, refer to "SLEEP mode function" and "ECONOMY mode function".

## 7 ▶ "I FEEL" BUTTON FOR ROOM TEMPERATURE DETECTION AND DISPLAY

- Activates **temperature detection** in the vicinity of the remote control. This function is available in AUTO, COOL and HEAT mode.

## 8 ▶ ION/CLEAN BUTTON

This button has 2 functions:

- **The ION function** (ionizer): short press
  - **The CLEAN function:** long press
- For more details, refer to "Ionizer mode function (OPTIONAL)" and "CLEAN mode function".

## 9 ▶ TURBO BUTTON

- Activates the **TURBO function** to speed up heating or cooling.

## 10 ▶ TIMER BUTTON (PROGRAMMING)

- Activates/deactivates **PROGRAMMING**.
- For more details, refer to "SETTING THE TIMER".

## 11 ▶ TEMPERATURE SETTING BUTTONS

- - (cooler). Reduce the set temperature.
  - + (warmer). Increase the set temperature.
- Press the "-" and "+" buttons simultaneously to lock or unlock the keypad.

## 12 ▶ FAN SPEED SELECTOR BUTTON

Press this button to change the mode.

	• The fan speed is selected automatically.		• High speed
	• Medium speed		• Low speed

Press this button for at least 2 seconds to activate Silent mode.

## 13 ▶ HORIZONTAL AIR SWEEP BUTTON

- If the air conditioner has a horizontal sweep motor, press the button to activate **automatic horizontal air sweeping**.

## 14 ▶ VERTICAL SWING BUTTON

- Activates **automatic vertical air sweep swing**.
- For more details, refer to "ADJUSTING THE AIRFLOW DIRECTION".

## 15 ▶ SET/CLEAR BUTTONS

- **SET button.** Selects the following functions: setting the time/setting the programming ON/OFF.  
For details, refer to "SETTING THE CURRENT TIME" and "SETTING THE TIMER".
- **CLEAR button.** Press the CLEAR button to cancel all programming operations.

## 16 ▶ LIGHT/EYE BUTTONS

- **LIGHT button.** Press this button to turn the indoor unit display ON/OFF. Turns beep ON/OFF.
- **EYE button (optional).** Detects human presence in the room and activates start or standby mode.

# RC08A

Part number: 7ACEL1791



## COMPATIBLE PRODUCTS

- HDLE Aura
- XDLF

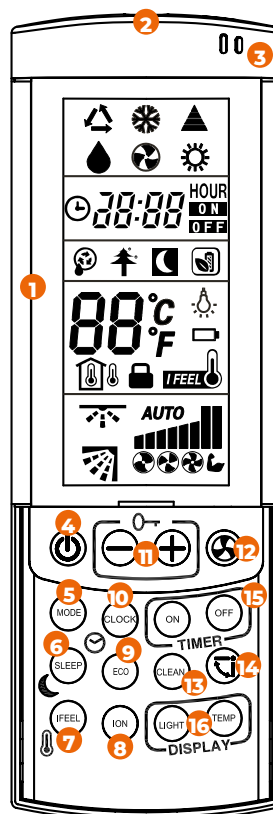

## 1 ► DISPLAY

Information is displayed when the remote control is on.

Operating mode		• Automatique
		• Heating
		• Cooling
		• Airflow only
		• Dehumidification (drying mode)
		• Send data to the air conditioner receiver
		• Clock (hours and minutes)
		• "Time On" function configured and activated
		• "Time Off" function configured and activated
		• Cleaning mode
		• Sleep operating mode
		• Ionizer /E.S.F. mode
		• Eco mode
		• Selects or indicates the room temperature
	Description of low battery detection	
		<ul style="list-style-type: none"> <li>• Low speed</li> <li>• Medium speed</li> <li>• High speed</li> <li>• Fan auto speed</li> <li>• Turbo function</li> </ul>

## 2 ▶ TRANSMITTER

- When you press the buttons of the remote control unit, the ▲ symbol appears on the display **to transmit the setting changes to the air conditioner receiver.**

## 3 ▶ SENSOR







- The air temperature sensor inside the remote control unit **measures the room temperature.**

## 4 ▶ ON/OFF BUTTON

- This button **turns the air conditioner ON and OFF.**

## 5 ▶ MODE SELECTOR BUTTON

Press this button to change the mode.

	• <b>Automatic.</b> When this mode is selected, the air conditioner calculates the difference between the thermostat setting and the room temperature and automatically switches to "cooling" or "heating" mode.
	• <b>Heating.</b> The air conditioner heats the ambient air.
	• <b>Cooling.</b> The air conditioner cools the room.
	• <b>Ventilation only.</b> The air conditioner circulates the air.
	• <b>Dehumidify (dry mode).</b> The air conditioner reduces the humidity of the air in the room.
	• <b>Cool / Dry / Heat</b>

## 6 ▶ SLEEP/ECO BUTTON

This button has 2 functions:

- **SLEEP function** (short press)
  - **ECONOMY function** (long press)
- For more details, refer to "SLEEP mode function" and "ECONOMY mode function".

## 7 ▶ "I FEEL" BUTTON FOR ROOM TEMPERATURE DETECTION AND DISPLAY

- Activates **temperature detection** in the vicinity of the remote control. This function is available in AUTO, COOL and HEAT mode.

## 8 ▶ ION/CLEAN BUTTON

This button has 2 functions:

- **The ION function** (ionizer): short press
  - **The CLEAN function:** long press
- For more details, refer to "Ionizer mode function (OPTIONAL)" and "CLEAN mode function".

## 9 ▶ ECO BUTTON

- **Cooling.** Automatically adjust the temperature for energy savings. The temperature display will show "SE".
- **Heating.** Select heating level 8. The remote control screen displays the temperature "8 C".

## 10 ▶ CLOCK BUTTON

- The clock displays the **current time.**
- For more details refer to the section "How to set the current time".

## 11 ▶ TEMPERATURE SETTING BUTTONS

- - (**cooler**). Reduce the set temperature.
  - + (**warmer**). Increase the set temperature.
- Press the "-" and "+" buttons simultaneously to lock or unlock the keypad.

## 12 ▶ FAN SPEED SELECTOR BUTTON

Press this button to change the mode.

	• The fan speed is selected automatically.		• High speed
	• Medium speed		• Low speed
	• Turbo function		

## 13 ▶ CLEAN BUTTON

- This button deactivates **the cleaning function** in Cooling and Dehumidification modes.

## 14 ▶ SWING BUTTON

- Activates **the air supply louver swing** in various positions or automatic swing.
- For more details refer to the section "Setting the airflow direction".

## 15 ▶ TIMER BUTTONS (ON/OFF)

- Press the ON or OFF button **to activate the setting procedure.**
- For more details refer to the section "Setting the timer".

## 16 ▶ LIGHT/TEMP BUTTONS

- **LIGHT button.** Enables or disables the remote control display.
- **TEMP button.** Displays the configured temperature, room temperature or outdoor temperature.

## SWITCHING TO HEATING MODE ONLY

- 
- Remove the batteries from the remote control.
  - Wait for the screen to turn off completely.
  - Insert the batteries.
  - Within 60 seconds of inserting the batteries: - The remote control must be in OFF mode.  
- Press "I FEEL" and "TEMP" at the same time for 5 s.  
- The heating mode icon will flash 3 times.
  - After this setting, the remote control is permanently locked in heating mode. No switching back.

# RC18

Part number: 7ACEL1898



### COMPATIBLE PRODUCTS

- FDMX
- DDMX (optional)
- CDMX

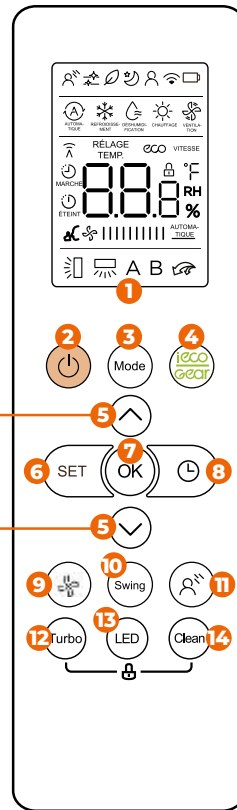

## 1 ► DISPLAY

Information is displayed when the remote control is on.			
Operating mode		• Breeze Away display	
		• Active clean feature display	
		• Fresh feature display	
		• Sleep mode display	
		• "I Feel" function display	
		• Wireless control feature display	
		• Low battery detection display (if flashing)	
		• AUTO mode	
		• COOLONG mode	
		• DRY mode	
		• HEATING mode	
		• FAN mode	
		• Transmission Indicator: lights up when remote sends signal to indoor unit	
		• TIMER ON display	
		• TIMER OFF display	
	Temperature/ Timer/Fan speed display		<ul style="list-style-type: none"> <li>• Displays the default set temperature, or fan speed or timer setting when using On/Off timer functions.</li> <li>• Temperature range: 16-30°C</li> <li>• Timer setting range: 0-24 hours</li> <li>• Fan speed setting range: AU -100%</li> <li>• This display is blank when operating in FAN mode.</li> </ul>
Fan speed display			• Silence 1%
			• Low 2%-20%
			• Medium 21%-40%
			• High 41%-60%
		• High 61%-80% • Auto 81%-100%	
Louver swing display		• Horizontal louver swing display	
		• Vertical louver auto swing display (optional function)	
	A B	Not available for this unit	
		• TURBO mode display	

## 2 ▶ ON/OFF BUTTON

- Turns the unit on or off.





## 3 ▶ MODE BUTTON

- Scrolls through operation modes as follows: AUTO → COOL → DRY → HEAT → FAN

## 4 ▶ ECO/GEAR BUTTON





- Press this button to enter the energy saving mode in the following sequence: ECO → GEAR (75%) → GEAR (50%) → Previous setting mode → ECO

## 5 ▶ TEMP BUTTON

-  Increases temperature in 1°C (1°F) increments. Max. temperature is 30°C (86°F).
-  Decreases temperature in 1°C (1°F) increments. Min. temperature is 16°C (60°F).
- **NOTE:** Pressing buttons  and  at the same time for 3 seconds will alternate the temperature display between the °C & °F.

## 6 ▶ SET BUTTON

Scrolls through the operating functions as follows:

- Fresh  → Sleep  → "I Feel"  → AP mode  → Fresh .
- The selected symbol will flash on the display area. Press the OK button to confirm.



## 7 ▶ OK BUTTON

- Used to confirm the selected functions

## 8 ▶ TIMER BUTTON

- Set the timer to turn the unit on or off.

## 9 ▶ FAN SPEED BUTTON

- Selects fan speeds in the following order: AU → 20% → 40% → 60% → 80% → 100%.
- Press the  or  button to increase/decrease the fan speed in 1% increments.

## 10 ▶ SWING BUTTON

- Starts and stops the louver movement.

## 11 ▶ BREEZE AWAY BUTTON

- This feature avoids direct air being blown directly at you or any other occupants.
- **NOTE:** This feature is available in Cooling, Fan and Dry modes only

## 12 ▶ TURBO BUTTON

- Enables unit to reach preset temperature in shortest possible time.

## 13 ▶ LED BUTTON

- Turns the air conditioner's buzzer on and off (depending model), which create a comfortable and quiet environment.

## 14 ▶ CLEAN BUTTON

- This function is used to clean the air conditioner's evaporator, to prevent frosting.

# RC19

Part number: 7ACEL1899

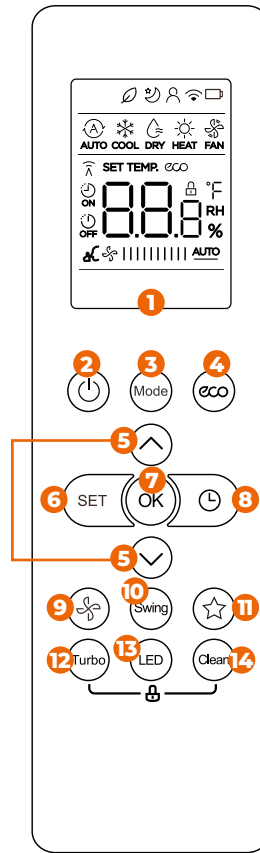

## COMPATIBLE PRODUCTS

- SDMX

## 1 ► DISPLAY

Information is displayed when the remote control is on.		
Operating mode		• Fresh function display • (No displays when Fresh function is activated)
		• Sleep mode display
		• "I Feel" function display
		• Wireless control function display
		• Low battery detection display (if flashing)
		• AUTO mode
		• COOLONG mode
		• DRY mode
		• HEATING mode
		• FAN mode
		• Transmission Indicator: lights up when remote sends signal to indoor unit
		• TIMER ON display
		• TIMER OFF display
		• Silence function display
Temperature/ Timer/Fan speed display		• Displays the default set temperature, or fan speed or timer setting when using On/Off timer functions. • Temperature range: 17-30 °C/62-86 °F (20-28 °C) (model dependent) • Timer setting range: 0-24 hours • This display is blank when operating in FAN mode.
		• Silence 1%
		• 2%-20%
Fan speed display		• Low 21%-40%
		• Medium 41%-60%
		• High 61%-80%
		• 81%-100%
		• Auto This fan speed can not be adjusted in AUTO or DRY mode.

## 2 ▶ ON/OFF BUTTON

- Turns the unit on or off.





## 3 ▶ MODE BUTTON

- Scrolls through operation modes as follows: AUTO → COOL → DRY → HEAT → FAN
- **NOTE:** HEAT mode is not supported by the cooling only appliance.

## 4 ▶ ECO BUTTON





- Press this button to enter the energy saving mode.

## 5 ▶ TEMP BUTTON

-  Increases temperature in 1°C (1°F) increments. Max. temperature is 30°C (86°F).
-  Decreases temperature in 1°C (1°F) increments. Min. temperature is 17°C (62°F).
- **NOTE:** Press buttons  and  at the same time for 3 seconds will alternate the temperature display between the °C & °F.

## 6 ▶ SET BUTTON

Scrolls through the operating functions as follows:

- Fresh  → Sleep  → "I Feel"  → AP mode  → Fresh 
- The selected symbol will flash on the display area, press the OK button to confirm.

## 7 ▶ OK BUTTON

- Used to confirm the selected functions

## 8 ▶ TIMER BUTTON

- Set the timer to turn the unit on or off.

## 9 ▶ FAN SPEED BUTTON

- Selects fan speeds in the following order: AUTO → LOW → MED → HIGH.
- **NOTE:** Hold down for 2 seconds to activate silent mode.

## 10 ▶ SWING BUTTON

- Starts and stops the horizontal louver movement.
- Hold down for 2 seconds to initiate louver auto vertical swing function.

## 11 ▶ SHORTCUT BUTTON

- Used to restore the current settings or resume previous settings.

## 12 ▶ TURBO BUTTON

- Enables unit to reach preset temperature in shortest possible time.

## 13 ▶ LED BUTTON

- Turns the air conditioner's buzzer on and off (depending model), which create a comfortable and quiet environment.

## 14 ▶ CLEAN BUTTON

- This function is used to clean the air conditioner's evaporator, to prevent frosting.

# RCW11

Part number: 7ACEL1774



## COMPATIBLE PRODUCTS

- DDMX
- CDMX (optional)
- FDMX (optional)

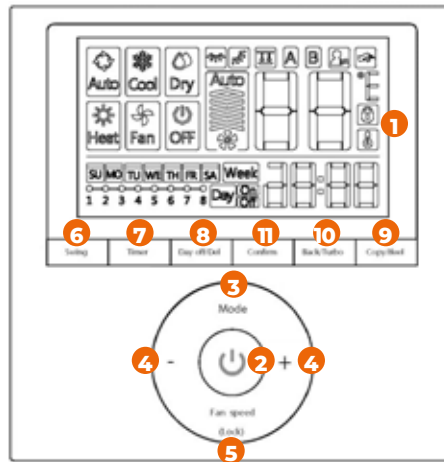

### 1 DISPLAY

Information is displayed when the remote control is on.

	• Operating mode
	• Ventilation speed
	• Louver left/right position
	• Louver up/down position
	• Panel (not used)
	• Master/slave unit
	• "I Feel" function
	• Turbo or auxiliary heating mode
	• Degrees (°C/°F)
	• Temperature display
	• Remote control locking
	• Ambient temperature
	• Time display
	• Programming ON/OFF
	• Programming display

### 2 ON/ OFF BUTTON



- To start/stop use, press the ON/OFF button.

### 3 MODE SELECTOR BUTTON

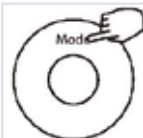

Press the MODE button to set the operating mode.  
(The HEAT function is not valid for a Cooling only type unit.)

	• <b>Automatic.</b> When this mode is selected, the air conditioner calculates the difference between the thermostat setting and the room temperature and automatically switches to "cooling" or "heating" mode.
	• <b>Cooling.</b> The air conditioner cools the room.
	• <b>Dehumidify (dry mode).</b> The air conditioner reduces the air humidity in the room.
	• <b>Heating.</b> The air conditioner heats the ambient air.
	• <b>Ventilation only.</b> The air conditioner circulates the air.
	• <b>The air conditioner is off.</b>



## 4 ▶ TEMPERATURE SETTING BUTTONS

- - (cooler). Reduce the set temperature.
- + (warmer). Increase the set temperature.

## 5 ▶ FAN SPEED SELECTION BUTTON



Press the button to set the ventilation speed.  
(This button is not available in Auto or Dehumidify mode)

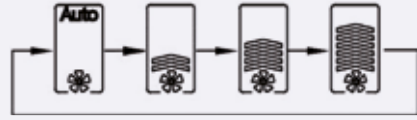

- Press the "Fan speed (Lock)" button for 3 seconds to activate the locking function and lock all the buttons on the wired remote control.

## 6 ▶ VERTICAL/HORIZONTAL SWING BUTTON



- Press the "SWING" button to start the up/down flap movement.
- Press it again to stop it.
- When the function is activated, the icon appears.



- Keep pressing the "SWING" button to start the louver left/right movement.
- Press it again to stop it.
- When the function is activated, the icon appears.

## 7 ▶ TIMER BUTTON (PROGRAMMING)



### WEEKLY programming

- Use this programming function to set the operating hours for each day of the week.



### Programming ON



### Programming OFF



### Programming ON/OFF

- Use this programming function to start and stop the air conditioner.
- The timer is activated and the air conditioner starts, and stops when the set time has elapsed.

## 6+7 ▶ BUTTON BEEP FUNCTION

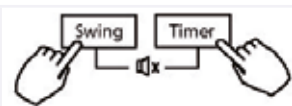

- Press the "SWING" and "TIMER" buttons simultaneously for 3 seconds to deactivate the button beep.

## 8 ▶ DAY OFF/DEL BUTTON



### This button has 2 functions:

- The DAY OFF function: press this button to set the day on which the air conditioner will shut down due to absence.
- The DEL function: to cancel the time, mode, temperature and fan speed.

## 9 ▶ "I FEEL" BUTTON FOR ROOM TEMPERATURE DETECTION AND DISPLAY



- Activates temperature detection in the vicinity of the remote control. This function is available in AUTO, COOL and HEAT mode.
- When the "I FEEL" icon the room temperature in the vicinity of the wired remote control is detected.

Copy/hold

- When programming, this button copies the setting for one day to another day.

## 10 ▶ TURBO BUTTON

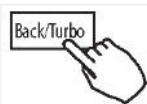

- Press the "BACK/TURBO" button to activate/deactivate the Turbo/Auxiliary heating function.
- The BACK function: when programming, this button allows you to go back a step.

## 10 ▶ BOUTON CONFIRM



- Confirms the programmed action.

## ALARM CODE MANAGEMENT

A malfunction code indicates the error code, which may be useful for servicing purposes.

N°	Alarm code explanation	Display
1	• Communication error between the remote control and the indoor unit.	F0
2	• The board is faulty.	F1

# RCW27

Part number: 7ACEL1874



## COMPATIBLE PRODUCTS

- HDLE Aura (optional)
- XDLF (optional)

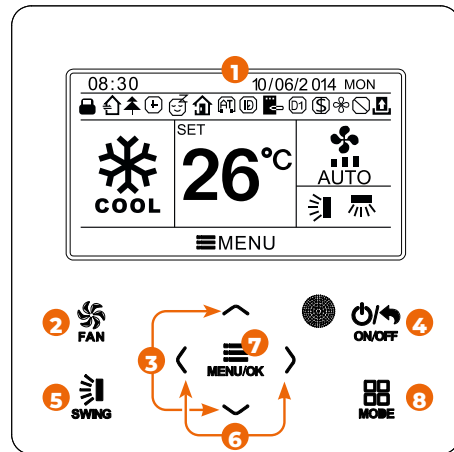

## 1 DISPLAY

Information is displayed when the remote control is on.	
	• Vertical swing function
	• Lateral swing function
	• FRESH AIR function
	• SLEEP function
	• AUTO mode
	• COOLING mode (air conditioning)
	• DRY mode
	• FAN mode
	• HEATING mode
	• HEALTH function (purification)
	• I-DEMAND function
	• AWAY function
	• Locking function (buttons, temperature, ON/OFF, mode and energy saving are locked by the remote display)
	• Current set fan speed
	• MEMORY function (in case of power failure)
	• DRED function
	• SAVE function (energy saving)
	• X-FAN function (turbo fan)
	• Timer Enabled Status
	• Door card removed or no-one present status
	• QUIET function
	• Function lock

## 2 FAN SPEED SELECTION BUTTON

Press the button to adjust the fan speed.

LOW, MEDIUM, HIGH, TURBO and AUTO.

## 3 TEMPERATURE SETTING BUTTONS

- (warmer). Raises the set temperature.
- (cooler). Lowers the set temperature.

**Notes:** - In AUTO mode, the set temperature cannot be adjusted.  
 - and also allow you to set the parameters and move the option slider.

## 4 ▶ ON/OFF/BACK OPERATION BUTTON

- To start/stop use, press the ON/OFF button.

## 5 ▶ SWING BUTTONS

Press this button to change mode.

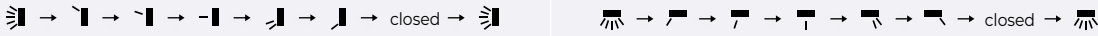

- Use to swing the air supply louver in various vertical and lateral positions.

## 6 ▶ FUNCTION SETTING BUTTONS

- ◀ and ▶ activate or deactivate the corresponding function.
- Notes:** Also used to set settings and move the option slider.

## 7 ▶ MENU/OK BUTTON

Press this button to change mode.

### Setting the FRESH AIR function

- Press the ▲ or ▼ button to select the FRESH AIR function then press ◀ or ▶ to activate or deactivate this function. Press the MENU button to set FRESH AIR mode. After entering the FRESH AIR mode setting, press the ▲ or ▼ button to set the mode in the range 1-10.
- When the setting is complete, press the MENU button to save the setting.

### Setting the SLEEP function

- Press the ▲ or ▼ button to select the SLEEP function then press ◀ or ▶ to activate or deactivate the SLEEP function with automatic save.
- If this feature is enabled, the unit operates from a preset sleep curve to provide a comfortable sleeping environment.

#### Notes:

- In FAN (fan) or Auto mode, the SLEEP function is not available.
- The SLEEP function can be canceled by turning off the unit or changing the mode.

### Setting the HEALTH function

- Press the ▲ or ▼ button to select the HEALTH function then press ◀ or ▶ to activate or deactivate this function with automatic save.

### Setting the I-DEMAND function

- Press the ▲ or ▼ button to select the I-DEMAND function then press ◀ or ▶ to activate or deactivate this function with automatic save.

#### Notes:

- This function is only available in COOLING mode.
- After this function is set, the set temperature displayed in SE. In this case, the temperature and fan speed settings are locked.
- This function is canceled by changing the mode.
- This function and the SLEEP function cannot be activated simultaneously. If the I-demand function is set first and then the SLEEP function, the first will be canceled and the second valid, and vice versa.

### Setting the HOLIDAY function

- Press the ▲ or ▼ button to select the HOLIDAY function then press ◀ or ▶ to activate or deactivate this function with automatic save.
- This function is used to maintain the indoor temperature so that the unit can heat up quickly.

#### Notes:

- This function is only available in HEATING mode.
- When this function is set, the set temperature displayed is 8°C (46°F). In this case, the temperature and fan speed settings are locked.
- This function is canceled by changing the mode.
- This function and the SLEEP function cannot be activated simultaneously. If the Holiday function is set first and then the SLEEP function, the first will be canceled and the second valid, and vice versa.

### Setting the MEMORY function

- Press the ▲ or ▼ button to select the MEMORY function then press ◀ or ▶ to activate or deactivate this function with automatic save.

### Setting the FIXED-ANGLE SWING mode

- Press the ▲ or ▼ button to select the LOCKED SWING function then press ◀ or ▶ to activate or deactivate this function with automatic save.

**Notes:** If the FIXED ANGLE SWING function is not available for the connected unit, this function will be automatically canceled after setting.

### Setting the SAVE function

- Press the ▲ or ▼ button to select the SAVE function then press ◀ or ▶ to activate or deactivate this function. Press the MENU button to enter the SAVE function setting page.
- After entering the SAVE function setting page, press the ◀ or ▶ button to select the cooling and heating limit temperature. After selecting the cooling and heating limit temperature, press the ◀ or ▶ button to adjust the limit temperature value. When the setting is complete, press the MENU button to save the setting.

**Notes:** Once the SAVE function has been set, it is not possible to set the AUTO mode.

### Setting the AUXILIARY HEATING function

- Press the ▲ or ▼ button to select the AUXILIARY HEATING function then press ◀ or ▶ to activate or deactivate this function with automatic save.

### Setting the X-FAN function

- Press the ▲ or ▼ button to select the DRY function, then press ◀ or ▶ to activate or deactivate this function with automatic save.

**Notes:** This function is only available in COOLING and DRY mode.

### Setting the QUIET function

- Press the ▲ or ▼ button to select the QUIET function, then press ◀ or ▶ to activate or deactivate this function with automatic save.

**Notes:** This function is only available in COOLING, HEATING and AUTO mode.

### Setting FAHRENHEIT TEMPERATURE

- Press the ▲ or ▼ button to select the FAHRENHEIT TEMPERATURE function, then press ◀ or ▶ to activate or deactivate this function with automatic save. Once this function is closed, the temperature will appear in Celsius.

### Setting the AIR function

- Press the ▲ or ▼ button to select the AIR function, then press ◀ or ▶ to activate or deactivate this function. Press the MENU button to set the AIR function mode. After entering the AIR function mode setting, press the ◀ or ▶ button to set the mode in the range 1-2.
- When the setting is complete, press the MENU button to save the setting.
- Each mode is equivalent to the following: 1. Suction/2. Exhaust.

## 8 ▶ MODE SELECTION BUTTON

Press this button to change mode.



- Automatic.** When this mode is selected, the air conditioner calculates the difference between the thermostat setting and the room temperature and automatically switches to COOLING or HEATING mode.



- Cooling.** The air conditioner cools the room.



- Dehumidification (drying).** The air conditioner dries the air in the room.



- Fan only.** The air conditioner circulates air.



- Heating.** The air conditioner heats the ambient air.



## COMPATIBLE PRODUCTS

- DFMO

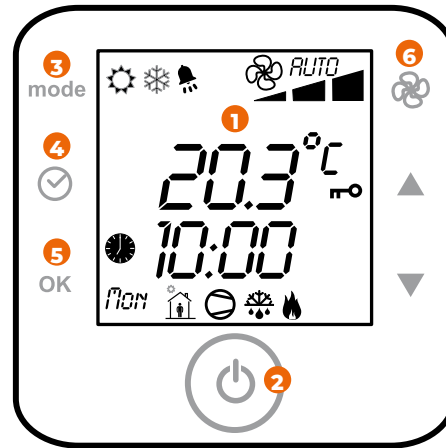

## 1 ► DISPLAY

Information is displayed when the remote control is on.

	• Operating mode: SUMMER
	• Operating mode: WINTER
<i>AUTO</i>	• Operating mode: AUTOMATIC
	• Exhaust fan speed
	• Alarm present
	• Keypad locked
	• Time bands active if the clock is visible
	• Time band active
	• Compressor active
	• Defrosting in progress
	• Auxiliary heater (Electrical resistors, hot water coil)

## 2 ► ON/ OFF BUTTON

- To start/stop use, press the ON/OFF button.

## 3 ► MODE SELECTOR BUTTON

Press this button to change the mode.

	• <b>Summer/Cooling.</b> The air conditioner cools the room.
	• <b>Winter/Heating.</b> The air conditioner heats the ambient air.
<i>AUTO</i>	• <b>Automatic.</b> When this mode is selected, the air conditioner calculates the difference between the thermostat setting and the room temperature and automatically switches to cooling or heating mode.

It is possible to modify the operating setpoint at any time using the ▲▼ buttons.

## 4 ► CHANGING THE TIME OR DAY

- Press the CLOCK button for 5 sec.
- Using the ▲▼ buttons select the CLOCK menu
- Confirm with the OK button
- The time flashes: adjust using the ▲▼ buttons
- Confirm with the OK button
- Repeat the procedure for the minutes and the day of the week
- To return to the main screen, select the "Esc" menu and confirm with OK

## 4+5 ON/ OFF BUTTON

- Press for 5 seconds to LOCK/UNLOCK the buttons.

## ECONOMY SETPOINT





The ECO setpoint is optimised to reduce energy consumption:

- In summer: the ECO set point is higher than the standard setpoint.
- In winter: the ECO set point is lower than the standard setpoint.











## PROGRAMMING TIME BANDS

4 types of programming are possible:

- 7 days (Monday to Sunday)
- 5 days (Monday to Friday)
- 2 days (Saturday to Sunday)
- Day by day

Daytime programming		Night-time programming	
	• Inside		• Inside
	• Outside		• Outside
	• Back home		• Back home

PROGRAMMATION JOUR PAR JOUR			
	<b>1</b> Press  for 5 seconds		<b>8</b> Select the next time band using ▲ <b>Press OK</b> Repeat the procedure
	<b>2</b> Select "TIME BANDS" using ▲▼ <b>Press OK</b>		<b>9</b> Select "ESC" using ▲▼ <b>Press OK</b>
	<b>3</b> Select "DAY BY DAY" using ▲▼ <b>Press OK</b>		<b>10</b> <b>Press OK</b> to programme the next day
	<b>4</b> <b>Press OK</b>		<b>11</b> Select the next day using ▲▼ <b>Press OK</b> Repeat the procedure
	<b>5</b> Display the hour using ▲▼ <b>Press OK</b>		<b>9</b> Select "ESC" to exit using ▲▼ <b>Press OK</b>
	<b>6</b> Display the minutes using ▲▼ <b>Press OK</b>		<b>13</b> Select "ESC" to exit using ▲▼ <b>Press OK</b>
	<b>7</b> Display the temperature using ▲▼ <b>Press OK</b>		

## PROGRAMMING ON/OFF

	<b>1</b> Press  to deactivate time band programming		<b>2</b> Programming deactivated: symbol hidden 
---	--	---	---

## ALARMS

- Any malfunctions are indicated on the display by the ALARM icon. Before resetting an alarm, identify and remove the cause that generated it.
- Repeated resets can cause irreversible damage such as a system malfunction.

To reset a present alarm:

- Press Mode + Clock for 5 sec.

## PARAMETERS

The configuration parameters are password protected to avoid unintentional changes which might affect the operation of the unit.

To access the parameters:





1. Press ON/OFF + FAN for 5 seconds
2. Enter the password: using the ▲▼ buttons. Code = 2
3. Confirm with OK
4. Select the PAR menu and confirm with OK
5. Scroll through the list ▲▼
6. Select the parameter with OK
7. Change the value ▲▼ and confirm with OK
8. Scroll up to exit





For more details, refer to "PARAMETERS" section in the manual.

## STATUSES

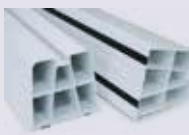
To access statuses:

- Press ON/OFF + FAN for 5 seconds.

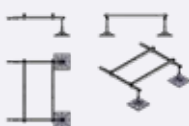
ACCESSORY	REFERENCE	PICTURE	PART NUMBER	FUNCTION
<b>COPPER</b>				
INSULATED COPPER MI	1/4"-3/8" - 10ml		7ACFH0810	<ul style="list-style-type: none"> <li>Refrigerant tubing to connect outdoor unit with indoor unit (monosplit and multisplit).</li> </ul>
	1/4"-1/2" - 10ml		7ACFH0811	
	3/8"-5/8" - 10ml		7ACFH0812	
	1/4"-3/8" - 7ml		7ACFH0813	
	1/4"-1/2" - 7ml		7ACFH0814	
	3/8"-5/8" - 7ml		7ACFH0815	
<b>OUTDOOR UNIT BRACKETS</b>				
WALL BRACKET	Max. load 160 kg Horiz. 560 mm Vert. 365 mm Barre 800 mm		7ACTL0506	<ul style="list-style-type: none"> <li>Bracket for outdoor unit installation (monosplit and multisplit).</li> </ul>
ANTI-CORROSIONWALL BRACKET	Max. load 160 kg Horiz. 460 mm Vert. 410 mm Barre 790 mm		7ACTL0507	<ul style="list-style-type: none"> <li>Bracket for outdoor unit installation (monosplit and multisplit).</li> </ul>
4 ANTI-VIBRATION PADS (KIT)			7ACTL0508	<ul style="list-style-type: none"> <li>Ideal for limiting noise and vibrations (good neighborhood).</li> </ul>
FLOOR MOUNT RECYCLED RUBBER (PAIR)	Length 600 mm		7ACTL0509	<ul style="list-style-type: none"> <li>Necessary for a professional installation.</li> <li>High quality: using rubber.</li> </ul>
	Length 1000 mm		7ACTL0510	
FLOOR MOUNT (PAIR)	450x100 mm		7ACTL0513	<ul style="list-style-type: none"> <li>Necessary for a professional installation.</li> <li>Good quality price ratio: using PVC.</li> </ul>

ACCESSORY	REFERENCE	PICTURE	PART NUMBER	FUNCTION
<b>VRF FRAME</b>				
VRF FRAME 4 FEET	Max. charge 500 kg 1000x1200 mm		7ACTL0514	• Available for all VRF outdoor unit range.
VRF FRAME 6 FEET	Max. charge 1040 kg 2000x1200 mm		7ACTL0515	• Available for all VRF outdoor unit range.
VRF EXTENSION 2 FEET	Max. charge 500 kg 1000x1200 mm		7ACTL0516	• Available for all VRF outdoor unit range.
<b>CONDENSATE PUMP</b>				
CONDENSATE PUMP MINI FLOWATCH MF2			7ACTL0517	• Evacuates condensates from indoor units.
CONDENSATE PUMP FLOWATCHDESIGN			7ACTL0518	• Evacuates condensates from indoor units.



## Regulations ON R410A FLUID CONCENTRATION

### CALCULATION EXAMPLE

Classic case of a hotel, i.e. a category "A" building.

#### THE PROJECT/EXAMPLE CHARACTERISTICS ARE:

- ▶ Typical 2-3\* hotel.
- ▶ DRV system designed to supply 12 to 16 rooms.
- ▶ Outdoor unit model 280 (10 HP).
- ▶ Reversible VRF that can supply up to 16 units.
- ▶ 11 kg of R410A refrigerant recommended.
- ▶ Smaller bedroom, bathroom included:  
13 m<sup>2</sup> > volume = 32.50 m<sup>3</sup>.
- ▶ CMV ventilation of 60 m<sup>3</sup>/h, i.e. 10 m<sup>3</sup> in 10 minutes.

#### THIS GIVES THE FOLLOWING CALCULATION:

- ▶ Room volume to take into account:  
**32.50 + 10 = 42.50 m<sup>3</sup>.**
- ▶ **MAXIMUM LOAD UNDER THE STANDARD:**  
**0.44 kg/m<sup>3</sup> x 42.5 m<sup>3</sup> = 18.7 kg of refrigerant**
- ▶ Since the calculation is determined for the room with the smallest volume, the total refrigerant capacity of the installation must be taken into account:
  - Outdoor unit (11 kg) + network backup.
  - The network back-up is calculated according to the lengths and diameters of the copper piping used. See refrigeration diagram.
- ▶ **MAXIMUM PROJECT LOAD CALCULATION:**  
**11 kg + (4.520 kg) = 15.520 kg of refrigerant**

COMPLIANT WITH REGULATIONS



# MEASURE UNITS

## Conversion

LENGTH			
1 inch (in)	0.0254 m		
1 foot (ft)	12 inches	0.3048 m	
1 yard (yd)	3 feet	0.9143 m	
1 mile (mi)	1.760 yards	1609 m	
1 nautical mile (nmi)	1852 m		
1 meter (m)	39.37 inches	3.28084 feet	1.09361 yard

MM	INCHES
6.35	1/4
9.52	3/8
12.70	1/2
15.88	5/8
19.05	3/4
22.22	7/8
25.40	1
28.58	1 1/8
31.75	1 1/4
38.10	1 1/2

VOLUME	
1 cubic inch (cu in)	16.387064 cm <sup>3</sup>
1 cubic foot (cu ft)	0.028317 m <sup>3</sup> /28.31685 dm <sup>3</sup>
1 cubic yard (cu yd)	0.76455 m <sup>3</sup>
1 pint	0.568 l
1 gallon-imp	4.546 l
1 gallon (US gal)	3.78541 l or dm <sup>3</sup>
1 cubic meter (m <sup>3</sup> )	35.31467 cu ft
1 cubic decimeter (dm <sup>3</sup> )	0.26428 gal
1 liter (l)	1 dm <sup>3</sup>

HP (HORSE POWER) *	BTU	KW
1	9000	2.637
1.5	12000	3.516
2	18000	5.274
2.5	24000	7.032
3	30000	8.79
5	45000	13.185

MASS VOLUME	
1 cu.ft/lb	62.43 dm <sup>3</sup> /kg
1 US gallon/pound	8.3 dm <sup>3</sup> /kg

DENSITY	
1 pound/cu.ft	0.016 kg/dm <sup>3</sup>

MASS		
1 ounce (oz)	28.349 g	
1 pound (lb)	16 oz	0.4536 kg
1 quintal U.S	100 lbs	
1 centweight	112 lbs	
1 short ton (US)	2000 lbs	907.18 kg
1 long ton (GB)	2240 lbs	1016.04 kg
1 quintal (q)	100 kg	
1 tonne (t)	1000 kg	

AREA		
1 square inch (in <sup>2</sup> )	6.4516 cm <sup>2</sup>	
1 square foot (ft <sup>2</sup> )	0.0929 m <sup>2</sup>	
1 square yard (yd <sup>2</sup> )	0.8361 m <sup>2</sup>	
1 square meter (m <sup>2</sup> )	1550 in <sup>2</sup>	10.76391 ft <sup>2</sup>

ENERGY - HEAT QUANTITY			
1 cal	4.18 joules		
1 Btu	0.252 kcal		1055 joules
1 Btu/lb.°F	1 kcal/kg °C		
1 kcal	1 millithermie		
1 fg/h	-1 kcal/h		
1 kcal/h	1.163 W		
1 Btu/h	0.293 W		
1 ton (US)	3024 kcal/h		3512 W
1 ton (GB)	3340 kcal/h		3878 W
1 watt (thermic)	0.86 kcal/h		

° Fahrenheit = °C x 9/5 + 32 / ° Celsius = (°F-32) x 5/9 / ° Celsius = T (Kelvin) - 273.15.  
\* Indicative values

Rated capacities of our products are given for air conditions as following:  
Cooling mode: 35°C out/27°C in (Dry bulb)  
Heating mode: +7°C out/20°C in (Dry bulb)

## NEW PRODUCT *naming system*

Discover below some tips to decipher our references and product codes more quickly.

### 1 ► UNDERSTANDING PRODUCT CODES

DIGIT N° 1	DIGIT N° 2 & 3 Product constitution	DIGIT N° 4 & 5 subfamily
2	AirSolar	VF VRF
7	Airwell	OG Chilled water terminal
E	Electra	KT Kit
J	Johnson	MB Monoblock
		SP Split (2 units)
		CK Unassembled product
		PR Spare part
		EN Renewable energy
		01 Floor ceiling
		02 High wall
		03 Ducted
		04 Cassette
		05 Window
		06 Monosplit condensing unit
		07 Console
		08 Portable
		09 Multisplit condensing unit
		10 Floor standing
		11 Airflow
		12 Rooftop unit
		13 Hydraulic module
		17 Thermodynamic water heater
		18 Vertical cabinet
		14 Monoblock condensing unit
		15 VRF water source
		19 Water source
		20 Water condenser
		21 Water-cooled condensing unit
		22 Hybrid panel
		23 Photovoltaic panel
		24 Heating panel
		25 Micro-inverter

### 2 ► UNDERSTANDING ACCESSORY CODES

DIGIT N° 1	DIGIT N° 2 & 3	DIGIT N° 4 & 5 (& 6)
7	Airwell assembled product	AC Accessories
		EL Electricity kit - Heating
		ELH Electricity kit - Heating / VRF
		FH Cold & hydraulic kit
		FHH Cold & hydraulic kit / VRF
		TL Sheeting Kit / Casing & Metal sheet Kit
		VF Fan & airflow kit
		VFH Fan & airflow / VRF kit

### 3 ► UNDERSTANDING SERIAL NUMBERS

Each unit (IDU or ODU) is also identify with a unique serial number which can assist tracing the unit.

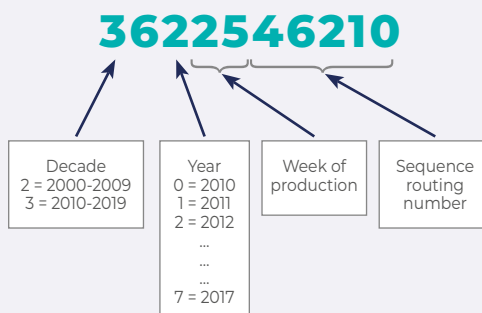

# Equivalences

## 2021 vs 2022

2021		2022	
OLD DESIGNATION	OLD PART NUMBER	NEW DESIGNATION	NEW PART NUMBER
<b>HDH high wall range</b>		<b>HDMB high wall range</b>	
AW-HDH009-N91	7SP023186	HDMB-025N-09M22	7SP023235
AW-HDH012-N91	7SP023187	HDMB-035N-09M22	7SP023236
AW-HDH018-N91	7SP023188	HDMB-050N-09M22	7SP023237
AW-HDH024-N91	7SP023189	HDMB-070N-09M22	7SP023238
-	-	HDMB-025N-09M22-MR	7SP23240
AW-HDH012-N91-B	7SP023216	HDMB-035N-09M22-MR	7SP023241
AW-HDH018-N91-B	7SP023217	HDMB-050N-09M22-MR	7SP023242
AW-HDH024-N91-B	7SP023218	HDMB-070N-09M22-MR	7SP023243
AW-HDH009-N91-G	7SP023211	HDMB-025N-09M22-GY	7SP023244
AW-HDH012-N91-G	7SP023212	HDMB-035N-09M22-GY	7SP023245
AW-HDH018-N91-G	7SP023213	HDMB-050N-09M22-GY	7SP023246
AW-HDH024-N91-G	7SP023214	HDMB-070N-09M22-GY	7SP023247
AW-YHDHA09-H91	7SP063150	YDAB-025H-09M22	7SP063155
AW-YHDHA12-H91	7SP063151	YDAB-035H-09M22	7SP063156
AW-YHDH018-H91	7SP063037	YDAB-050H-09M22	7SP063157
AW-YHDH024-H91	7SP063038	YDAB-070H-09M22	7SP063158
<b>HDLW high wall range</b>		<b>HDLE high wall range</b>	
AW-HDLW007-N91	7SP023200	HDLE-022N-09M25	7SP023270
AW-HDLW009-N91	7SP023201	HDLE-025N-09M25	7SP023271
AW-HDLW012-N91	7SP023202	HDLE-035N-09M25	7SP023272
AW-HDLW018-N91	7SP023203	HDLE-050N-09M25	7SP023273
AW-HDLW024-N91	7SP023204	HDLE-070N-09M25	7SP023274
-	-	YDAE-022R-09M25	7SP063200
AW-YHDL009-H91	7SP062960	YDAE-025R-09M25	7SP063201
AW-YHDL012-H91	7SP062961	YDAE-035R-09M25	7SP063202
AW-YHDL018-H91	7SP062962	YDAE-050R-09M25	7SP063203
AW-YHDL024-H91	7SP062963	YDAE-070R-09M25	7SP063204
<b>XDL console range</b>		<b>XDLF console range</b>	
AW-XDL009X-N91	7SP071424	XDLF-025N-09M25	7SP071440
AW-XDL012-N91	7SP071425	XDLF-035N-09M25	7SP071441
AW-XDL018-N91	7SP071426	XDLF-050N-09M25	7SP071442
AW-YXDL012-H91	7SP063101	YDAF-035R-09M25	7SP063205
AW-YXDL018-H91	7SP063102	YDAF-050R-09M25	7SP063206
<b>FWDB floor ceiling range</b>		<b>FDLK floor ceiling range</b>	
AW-FWDB018-N91	7SP012290	FDLK-050N-09M25	7SP012315
AW-FWDB024-N91	7SP012291	FDLK-070N-09M25	7SP012316
AW-YMDB018-H91	7SP063114	YDAK-050R-09M25	7SP063195
AW-YMDB024-H91	7SP063115	YDAK-070R-09M25	7SP063196
<b>HKD R32 high wall range</b>		<b>HDLA high wall range</b>	
AW-HKD009-N91	7SP023135	HDLA-025N-09M25	7SP023250
AW-HKD012-N91	7SP023136	HDLA-035N-09M25	7SP023251
AW-HKD018-N91	7SP023137	HDLA-050N-09M25	7SP023252
AW-HKD024-N91	7SP023138	HDLA-070N-09M25	7SP023253
AW-YKD009-H91	7SP063040	YDAA-025H-09M25	7SP063160
AW-YKD012-H91	7SP063041	YDAA-035H-09M25	7SP063161
AW-YKD018-H91	7SP063042	YDAA-050H-09M25	7SP063162
AW-YKD024-H91	7SP063043	YDAA-070H-09M25	7SP063163

# Equivalences

## 2021 vs 2022

2021		2022	
OLD DESIGNATION	OLD PART NUMBER	NEW DESIGNATION	NEW PART NUMBER
<b>YDZC multisplit range</b>		<b>ZDAA multisplit range</b>	
AW-YDZC218-H91	7SP091191	ZDAA-2050-09M25	7SP091195
AW-YDZC327-H91	7SP091192	ZDAA-3080-09M25	7SP091196
AW-YDZC436-H91	7SP091183	ZDAA-4090-09M25	7SP091197
AW-YDZC542-H91	7SP091184	ZDAA-5130-09M25	7SP091198
<b>YDZB multisplit range</b>		<b>ZDAE multisplit range</b>	
-	-	ZDAE-2040-09M25	7SP091200
AW-YDZB218-H91	7SP091178	ZDAE-2050-09M25	7SP091201
-	-	ZDAE-3060-09M25	7SP091202
AW-YDZB327-H91	7SP091179	ZDAE-3070-09M25	7SP091203
AW-YDZB430-H91	7SP091180	ZDAE-4080-09M25	7SP091204
AW-YDZB542-H91	7SP091190	ZDAE-5130-09M25	7SP091205
<b>HKD R410A high wall range</b>		<b>HDLS high wall range</b>	
AWSI-HKD009-N11	7SP023130	HDLS-025N-01M25	7SP023255
AWSI-HKD012-N11	7SP023131	HDLS-035N-01M25	7SP023256
AWSI-HKD018-N11	7SP023132	HDLS-050N-01M25	7SP023257
AWSI-HKD024-N11	7SP023133	HDLS-070N-01M25	7SP023258
AWAU-YKD009-H11	7SP062910	YDAS-025H-01M25	7SP063165
AWAU-YKD012-H11	7SP062911	YDAS-035H-01M25	7SP063166
AWAU-YKD018-H11	7SP062952	YDAS-050H-01M25	7SP063167
AWAU-YKD024-H11	7SP062913	YDAS-070H-01M25	7SP063168
<b>YCZ multisplit range</b>		-	
AWAU-YCZ218-H11	7SP091185	-	-
AWAU-YCZ327-H11	7SP091186	-	-
AWAU-YCZ430-H11	7SP091187	-	-
AWAU-YCZ542-H11	7SP091173	-	-

## TERTIAIRE R32

<b>CDM R32 cassette range</b>		<b>CDMX R32 cassette range</b>	
AW-CDM009X-N91	7SP042261X	CDMX-025N-09M25	7SP042290
AW-CDM012-N91	7SP042262	CDMX-035N-09M25	7SP042291
AW-CDM018-N91	7SP042263	CDMX-050N-09M25	7SP042292
AW-CDM024-N91	7SP042264	CDMX-070N-09M25	7SP042293
AW-CDM036-N91	7SP042265	CDMX-100N-09M25	7SP042294
AW-CDM048-N91	7SP042266	CDMX-140N-09M25	7SP042295
<b>Panel</b>		-	
Panel CBD/CBF/CCD/CFM/CFM 647x647	7ACVF0566	-	7ACVF0566
Panel CBD/CBF/CCD/CFM/CDM 950x950	7ACVF0564	-	7ACVF0600
<b>DDM R32 ducted range</b>		<b>DDMX R32 ducted range</b>	
AW-DDM012-N91	7SP033031	DDMX-035N-09M25	7SP033070
AW-DDM018-N91	7SP033032	DDMX-050N-09M25	7SP033071
AW-DDM024-N91	7SP033033	DDMX-070N-09M25	7SP033072
AW-DDM036-N91	7SP033034	DDMX-100N-09M25	7SP033073
AW-DDM048-N91	7SP033035	DDMX-140N-09M25	7SP033074
AW-DDM060-N91	7SP033036	DDMX-175N-09M25	7SP033075



= Product whose technical data has changed between 2021 and 2022.

# Equivalences

## 2021 vs 2022

2021		2022	
OLD DESIGNATION	OLD PART NUMBER	NEW DESIGNATION	NEW PART NUMBER
<b>FDM R32 floor ceiling range</b>		<b>FDMX R32 floor ceiling range</b>	
AW-FDM018-N91	7SP012263	<b>FDMX-050N-09M25</b>	<b>7SP012300</b>
AW-FDM024-N91	7SP012264	<b>FDMX-070N-09M25</b>	<b>7SP012301</b>
AW-FDM036-N91	7SP012265	<b>FDMX-100N-09M25</b>	<b>7SP012302</b>
AW-FDM048-N91	7SP012266	<b>FDMX-140N-09M25</b>	<b>7SP012303</b>
AW-FDM060-N91	7SP012267	<b>FDMX-175N-09M25</b>	<b>7SP012304</b>
<b>XDM R32 console range</b>		<b>XDMX R32 console range</b>	
AW-XDM012X-N91	7SP071413X	<b>under development</b>	
AW-XDM018-N91	7SP071414	<b>under development</b>	
<b>SDM R410A floor standing range</b>		<b>SDMX R32 floor standing range</b>	
AW-SDM048-N11	7SP011088	<b>SDMX-140N-09M35</b>	<b>7SP101060</b>
AW-YSDM048-H11	7SP062971	<b>YDAX-140H-09T35</b>	<b>7SP063175</b>
<b>R32 tertiary outdoor unit</b>		<b>R32 tertiary outdoor unit</b>	
AW-YDFA012-H91	7SP063050	<b>YDAX-035H-09M25</b>	<b>7SP063170</b>
AW-YDFA018-H91	7SP063051	<b>YDAX-050H-09M25</b>	<b>7SP063171</b>
AW-YDFA024-H91	7SP063052	<b>YDAX-070H-09M25</b>	<b>7SP063172</b>
AW-YDFA036-H91	7SP063053	<b>YDAX-100H-09M25</b>	<b>7SP063173</b>
AW-YDFA036-H93	7SP063054	<b>YDAX-100H-09T35</b>	<b>7SP063174</b>
AW-YDFA048-H93	7SP063055	<b>YDAX-140H-09T35</b>	<b>7SP063175</b>
AW-YDFA060-H93	7SP063056	<b>YDAX-175H-09T35</b>	<b>7SP063176</b>
<b>XDA console range</b>		<b>XDA console range</b>	
AW-XDA009-N91	7SP071430	<b>No change in designation and part number</b>	
<b>WFD window range</b>		<b>WFAE window range</b>	
AWWR-WFD009-C11	7WT010008	<b>WFAE-025C-09M25</b>	<b>7MB050001</b>
AWWR-WFD012-C11	7WT010009	<b>WFAE-035C-09M25</b>	<b>7MB050002</b>
<b>Portable range</b>		<b>Portable range</b>	
AW-MFH010-C41	7MB021060	<b>No change in designation and part number</b>	
AW-MFH012-C41	7MB021061		
AW-MFR012-H41	7MB021062		
<b>XDO console range</b>		<b>XDOW console range</b>	
AW-XDO009-H11	7CW011020	<b>XDOW-025R-01M25</b>	<b>7MB070001</b>
AW-XDO012-H11	7CW011021	<b>XDOW-035R-01M25</b>	<b>7MB070002</b>
<b>GCAO water-cooled condensing range</b>		<b>YDOX water-cooled condensing range</b>	
GCAO 9N	7SP101040	<b>YDOX-025R-09M25</b>	<b>Lancement mi-2022</b>
GCAO 12N	7SP101041	<b>YDOX-035R-09M25</b>	<b>Lancement mi-2022</b>
GCAO 18N	7SP101045	<b>YDOX-052R-09M25</b>	<b>Lancement mi-2022</b>
GCAO 24N	7SP101044	<b>YDOX-070R-09M25</b>	<b>Lancement mi-2022</b>
<b>Wellea WT range</b>		<b>Wellea WT range</b>	
AW-YHPSA04-H91	7HP061065	<b>No change in designation and part number before validation of the certification</b>	
AWYHPSA06-H91	7HP061066		
AWYHPSA08-H91	7HP061067		
AW-YHPSA10-H91	7HP061068		
AW-YHPSA12-H91	7HP061069		
AW-YHPSA14-H91	7HP061070		
AW-YHPSA16-H91	7HP061071		
AW-YHPSA12-H93	7HP061072		
AW-YHPSA14-H93	7HP061073		
AW-YHPSA16-H93	7HP061074		
ODMA-100T-09M22-19	7SP130001		
ODMA-100T-09M22-25	7SP130002		
ODMA-160T-09M22-25	7SP130003		



= Product whose technical data has changed between 2021 and 2022.

# Equivalences

## 2021 vs 2022

2021		2022	
OLD DESIGNATION	OLD PART NUMBER	NEW DESIGNATION	NEW PART NUMBER
<b>Wellea Split range</b>		<b>Wellea Split range</b>	
AW-YHPSA04-H91	7HP061065	<b>No change in designation and part number before validation of the certification</b>	
AW-YHPSA06-H91	7HP061066		
AW-YHPSA08-H91	7HP061067		
AW-YHPSA10-H91	7HP061068		
AW-YHPSA12-H91	7HP061069		
AW-YHPSA14-H91	7HP061070		
AW-YHPSA16-H91	7HP061071		
AW-YHPSA12-H93	7HP061072		
AW-YHPSA14-H93	7HP061073		
AW-YHPSA16-H93	7HP061074		
AW-WHPSA0406-N91	7HP010015		
AW-WHPSA0810-N91	7HP010016		
AW-WHPSA1216-N91	7HP010017		
AW-WHPSA1216-N93	7HP010018		
<b>Wellea Monoblock range</b>			<b>Wellea Monoblock range</b>
AW-WHPMA04-H91	7HP061075	<b>No change in designation and part number before validation of the certification</b>	
AW-WHPMA06-H91	7HP061076		
AW-WHPMA08-H91	7HP061077		
AW-WHPMA10-H91	7HP061078		
AW-WHPMA12-H91	7HP061079		
AW-WHPMA14-H91	7HP061080		
AW-WHPMA16-H91	7HP061081		
AW-WHPMA12-H93	7HP061082		
AW-WHPMA14-H93	7HP061083		
AW-WHPMA16-H93	7HP061084		
<b>Wellea Monoblock DF range</b>			<b>Wellea Monoblock DF range</b>
AW-WHPMA18-H93	7HP061085	<b>No change in designation and part number before validation of the certification</b>	
AW-WHPMA22-H93	7HP061086		
AW-WHPMA26-H93	7HP061087		
AW-WHPMA30-H93	7HP061088		
<b>TDF Thermodynamic water heater range</b>		<b>TDF Thermodynamic water heater range</b>	
AW-TDF190-H31	7HP030016	<b>No change in designation and part number before validation of the certification</b>	
AW-TDF300-H31	7HP030017		
AW-TDF190-Solar-H31	7HP030018		
AW-TDF300-Solar-H31	7HP030019		
<b>DFO Water-loop heat pump range</b>		<b>DFMO Water-loop heat pump range</b>	
AW-DFO005-H11	7OG091075	<b>DFMO-022N-01M25</b>	<b>7MB030001</b>
AW-DFO009-H11	7OG091076	<b>DFMO-031N-01M25</b>	<b>7MB030002</b>
AW-DFO017-H11	7OG091077	<b>DFMO-041N-01M25</b>	<b>7MB030003</b>
AW-DFO021-H11	7OG091078	<b>DFMO-045N-01M25</b>	<b>7MB030004</b>
AW-DFO031-H11	7OG091079	<b>DFMO-080N-01M25</b>	<b>7MB030005</b>
AW-DFO051-H11	7OG091081	<b>DFMO-100N-01M25</b>	<b>7MB030006</b>
AW-DFO071-H13	7OG091082	<b>DFMO-170N-01T35</b>	<b>7MB030007</b>
AW-DFO101-H13	7OG091084	<b>DFMO-250N-01T35</b>	<b>7MB030008</b>
<b>VMC AIRFLOW range</b>		<b>VMC AIRFLOW range</b>	
AW-AIRFLOW250-N91	7HP080005	<b>JDAА-022R-09M25</b>	<b>7MB110001</b>



= Product whose technical data has changed between 2021 and 2022.

# Equivalences

## 2021 vs 2022

2021		2022	
OLD DESIGNATION	OLD PART NUMBER	NEW DESIGNATION	NEW PART NUMBER
<b>TERTIAIRE R410A</b>			
<b>CFM R410A On/Off cassette range</b>		<b>CFMD R410A On/Off cassette range</b>	
AW-CFM012-N11	7SP042267	CFMD-035N-01M25	7SP042300
AW-CFM018-N11	7SP042268	CFMD-050N-01M25	7SP042301
AW-CFM024-N11	7SP042269	CFMD-070N-01M25	7SP042302
AW-CFM036-N11	7SP042270	CFMD-100N-01M25	7SP042303
AW-CFM048-N11	7SP042271	CFMD-140N-01M25	7SP042304
<b>Panel</b>		<b>-</b>	
Panel CBD/CBF/CCD /CDM/CFM 647*647	7ACVF0566	-	7ACVF0566
Panel CBD/CBF/CCD /CFM/CDM 950*950	7ACVF0564	-	7ACVF0600
<b>DFM R410A On/Off ducted range</b>		<b>DFMD R410A On/Off ducted range</b>	
AW-DFM018-N11	7SP032206	DFMD-050N-01M25	7SP033080
AW-DFM024-N11	7SP032207	DFMD-070N-01M25	7SP033081
AW-DFM036-N11	7SP033065	DFMD-100N-01M25	7SP033082
AW-DFM036T-N11	7SP032209	DFMD-100N-01T35	7SP033083
AW-DFM048-N11	7SP032210	DFMD-140N-01M25	7SP033084
AW-DFM060-N11	7SP032211	DFMD-160N-01M25	7SP033085
<b>FFM R410A On/Off floor ceiling range</b>		<b>FFMD R410A On/Off floor ceiling range</b>	
AW-FFM018-N11	7SP012268	-	-
AW-FFM024-N11	7SP012269	-	-
AW-FFM036-N11	7SP012295	FFMD-100N-01M25	7SP012310
AW-FFM036T-N11	7SP012270	FFMD-100N-01T25	7SP012311
AW-FFM048-N11	7SP012271	FFMD-140N-01M25	7SP012312
AW-FFM060-N11	7SP012272	FFMD-160N-01M25	7SP012313
<b>YFFA R410A On/Off outdoor unit</b>		<b>YFAD R410A On/Off outdoor unit</b>	
AW-YFFA012-H11	7SP063065	YFAD-035R-01M25	7SP063180
AW-YFFA018-H11	7SP063066	YFAD-050R-01M25	7SP063181
AW-YFFA024-H11	7SP063067	YFAD-070R-01M25	7SP063182
AW-YFFA036-H11	7SP063125	YFAD-100R-01M25	7SP063183
AW-YFFA036-H13	7SP063069	YFAD-100R-01T35	7SP063184
AW-YFFA048-H13	7SP063126	YFAD-140R-01T35	7SP063185
AW-YFFA060-H13	7SP063127	YFAD-160R-01T35	7SP063186
<b>SFM R410A On/Off floor standing</b>		<b>SFMD R410A On/Off floor standing range</b>	
AW-SFM048-N13	7SP011290	SFMD-140N-01N35	7SP010161
AW-YSFM048-H13	7SP062859	YFAD-140R-01T35	7SP063185
<b>HHF R410A On/Off high wall range</b>		<b>HHF R410A On/Off high wall range</b>	
AWSI-HHF009-N11	7SP023146	AWSI-HHF009-N11	7SP023225
AWSI-HHF012-N11	7SP023147	AWSI-HHF012-N11	7SP023226
AWSI-HHF018-N11	7SP023148	AWSI-HHF018-N11	7SP023227
AWSI-HHF024-N11	7SP023149	AWSI-HHF024-N11	7SP023228
AWAU-YGF009-H11	7SP063057	AWAU-YGF009-H11	7SP063145
AWAU-YGF012-H11	7SP063058	AWAU-YGF012-H11	7SP063146
AWAU-YGF018-H11	7SP063059	AWAU-YGF018-H11	7SP063147
AWAU-YGF024-H11	7SP063060	AWAU-YGF024-H11	7SP063148



= Product whose technical data has changed between 2021 and 2022.

# Equivalences 2021 vs 2022

2021		2022	
OLD DESIGNATION	OLD PART NUMBER	NEW DESIGNATION	NEW PART NUMBER
		HFLS R410A On/Off high wall range	
		HFLS-022N-01M25	7SP023260
		HFLS-025N-01M25	7SP023261
		HFLS-035N-01M25	7SP023262
		HFLS-050N-01M25	7SP023263
		HFLS-070N-01M25	7SP023264
		YFAS-022R-01M25	7SP063190
		YFAS-025R-01M25	7SP063191
		YFAS-035R-01M25	7SP063192
		YFAS-050R-01M25	7SP063193
		YFAS-070R-01M25	7SP063194





## Sizing THE AIR CONDITIONING

### STEP 1: EVALUATING THE NEEDS

In order to size properly your air conditioning installation, it's important to calculate the thermal needs of your habitation to calculate the power needed for your installation.

#### SIZING THE COOLING NEEDS BY OCCUPANCY RATIO

We use the following ratio to calculate the cooling capacity needed:

$$90 \text{ W/m}^2 + 100 \text{ W/Occupant}$$

The calculation is to be done room by room.

#### SIZING THE HEATING NEEDS BY THE G METHOD

The G is the volume loss coefficient of the building, corresponding to the total thermal losses through walls, windows, roofs... It's expressed in  $\text{W/m}^3/\text{°C}$ . This coefficient is related to the building insulation.

$$\text{Heating capacity (W)} = G \times V \times \Delta T$$

**G** = global loss coefficient ( $\text{W/m}^3/\text{°C}$ ):

- ▶ 0.65  $\text{W}/\text{°C m}^3$  RT 2012 constructions
- ▶ 0.75  $\text{W}/\text{°C m}^3$  construction after 2000
- ▶ 0.9  $\text{W}/\text{°C m}^3$  constructions after 1980
- ▶ 1.2  $\text{W}/\text{°C m}^3$  moderately insulated constructions
- ▶ 1.8  $\text{W}/\text{°C m}^3$  poorly insulated constructions

**V** = building volume ( $\text{m}^3$ )

**$\Delta T$**  = Difference between indoor temperature (19 or 20°C), and average outdoor temperature in the region where the project is based.

### STEP 2: OUTDOOR UNIT SELECTION

- ▶ Divide the cooling and heating needs calculated before (see step 1).
- ▶ Calculate the global needs by zone, in order to determine outdoor unit capacity.

STEP 2: EXTERIOR UNIT SELECTION			
Zone	Room	Cooling needed (kW)	Heating needed (kW)
ZONE 1	Room n°1		
	Room n°2		
	Room n°3		
	Room n°4		
	Room n°5		
	Room n°6		
	<b>Total</b>		
ZONE 2	Room n°1		
	Room n°2		
	Room n°3		
	Room n°4		
	Room n°5		
	Room n°6		
	<b>Total</b>		
ZONE 3	Room n°1		
	Room n°2		
	Room n°3		
	Room n°4		
	Room n°5		
	Room n°6		
	<b>Total</b>		



## CALCULATION OF NEEDS

Example of simplified heat balance using the following formula:

$$D = G \times V \times \Delta T$$

- ▶ **D** = represents heat loss in Watts.
- ▶ **G** = is the volume ratio of heat loss, corresponding to the insulation of the house (in W/m<sup>3</sup>/°K).
- ▶ **V** = is volume of the house in m<sup>3</sup>.
- ▶ **ΔT** = is the difference between the basic outdoor temperature and the indoor temperature.

This balance does not replace the one performed by a design office, which is recommended for all types of installations, in particular for specific buildings (architecture, insulation, etc.).

EXAMPLES	
New-build (very well insulated)	G = 0.4
Insulated house	G = 0.9
Modern house	G = 1.0
Poorly insulated old house (standard wall)	G = 1.3
Veranda	G = 2.5 à 3.0

## HEAT PUMP SELECTION

Select heat pump capacity depends on heat losses:

- 1 ▶ **Sizing a HT heat pump and its electrical backup or boiler (ON/OFF bi-compressor solution)**
  - 70% of losses ≤ Heating capacity of the heat pump ≤ 100% of losses
  - 120% of losses = Total power delivered by the heat pump + backup (electrical or fossil energy).
  - Basic outdoor temperature ≤ Heat pump operating limit temperature - 5°C.
- 2 ▶ **Sizing a LT heat pump and its electrical backup or boiler (DC Inverter bi-compressor solution)**
  - 80% of losses ≤ Heating capacity of the heat pump ≤ 100% of losses
  - 120% of losses = Total power delivered by the heat pump + backup (electrical or fossil energy).
  - Basic outdoor temperature ≤ Heat pump operating limit temperature - 5°C.

## DHW POWER CALCULATION

### Domestic Hot Water needs

NUMBER OF PEOPLE IN THE HOME	1	2	3	4	5
DAILY WATER NEEDS BY PERSON (IN LITERS OF WATER AT 40°C)	80 ± 35	60 ± 25	50 ± 20	45 ± 20	45 ± 20

Preparation with accumulation only: the DHW is produced in 6 or 8 hours.

Equivalent volume at 60°C:

$$V_{60} = V_x \frac{T_x - 10^\circ}{60^\circ - 10^\circ}$$

with: **T<sub>x</sub>** = storage temperature of the DHW tank  
**V<sub>x</sub>** = water volume at storage temperature T<sub>x</sub>

### STEP 1 ▶ Energy drawn during the day

- ▶ It consists in calculating the maximum volume of hot water (equivalent to 60°C) drawn during the heaviest-laden day of the year.
- ▶ The energy drawn via hot water is given by the formula:

$$E_{acc} = 1.16 V_{60acc} (60^\circ - 10^\circ) / 1000$$

with: **E<sub>acc</sub>** = energy drawn over a full day in kW/h  
**V<sub>60acc</sub>** = total hot water drawn during a day, including all usage, adjusted to 60°C, in liters  
**1.16/1000** = adjustment coefficient  
**10°** = cold water temperature

### STEP 2 ▶ Storing volume and exchanger capacity

- ▶ Storage tank volume given in liters by:

$$\text{Volume} = \frac{1000 \times E_{acc}}{1.16 \times (T_{ec} - 10^\circ) \times a}$$

with: **T<sub>ec</sub>** = water temperature in the tank (between 55 and 60°C)  
**10°** = cold water temperature, being the minimum temperature reached by the water in the tank while guaranteeing users comfort  
**a** = storage efficiency coefficient (between 0.8 and 0.95)

- ▶ The exchanger capacity, given in kW by the following formula, allows to recover the hot water stock in 6 or 8 hours.

$$\text{Heat exchanger capacity (DHW)} = \frac{E_{acc}}{6 \text{ à } 8 \text{ h} \times 0.9} + P_{dis}$$

with: **P<sub>dis</sub>** = losses in distribution circuit. In case of a distribution loop, it will be the power needed for maintaining the temperature in the loop.  
**0,9** = add-on factor, offsetting the storage losses during the stock restoration period

- ▶ Generally, a minimum power of 10 to 12 W/l per stored liter.

# Sizing THE HYDRAULIC ACCESSORIES

## BUFFER VOLUME

Airwell recommends a minimal water content that must be connected to the heat pump. This content:

- ▶ Ensures a sufficient inertia
- ▶ Maintains a minimum run compressor run time (anti-short cycle)

**Approximate buffer volume for a low-temperature heat pump** (runtime 6 min):

Heat pump power (in kW) under +7°C/35°C conditions	4	6	8	10	12	14	16
Power reduced to 20% for an Inverter heat pump (in kW)	1.2	1.8	2.4	3.0	3.6	4.2	4.8
Buffer capacity (in liters)	20	30	40	50	60	70	80

**Approximate buffer volume for a high temperature heat pump** (runtime 6 min):

Heat pump power (in kW) with +7°C/35°C conditions	4	6	8	10	12	14	16
Buffer volume capacity (in liters)	70	100	140	170	200	240	280

## EXPANSION TANK

The expansion tank should be sized based on the heating mode, and consists in calculating:

- ▶ The inflation pressure
- ▶ Its capacity

The inflation pressure must be higher than the static pressure of the installation so that, on cold cycle, the water cannot enter the tank and the volume is optimum for absorbing the water expansion.

The tank capacity must be able to cope with the expansion volume of the installation.

**For a pressure setting at 3 bars and a water installation at 45°C, we can use:**

MAXIMUM CAPACITY OF THE INSTALLATION (IN LITERS)	EXPANSION TANK CAPACITY (IN LITERS) FOR A STATIC HEIGHT OF UP TO:		
	5 m	10 m	15 m
200	4	5	8
250	5	7	10
300	6	8	12
400	8	11	16
500	10	14	20

## PEP ECOPASSPORT®



Airwell is part of an eco-environmental approach including a life cycle analysis of our products, and drawing up a Product Environmental Profile (PEP).

This life cycle analysis (LCA) allowed us to inventory and quantify, throughout the products life cycles, the physical material and energy flow associated with human activities. All the life cycle phases have been taken into account: raw materials, manufacturing, transport, distribution, usage, end of life and recycling.

The PEP meets the requirements of ISO 14025, 14040 and 14044. It allows us to anticipate the regulatory obligations, and forms part of the ecodesign approach which Airwell wants to follow. Finally, drawing up a POP allowed us to determine the environmental performance of some products.

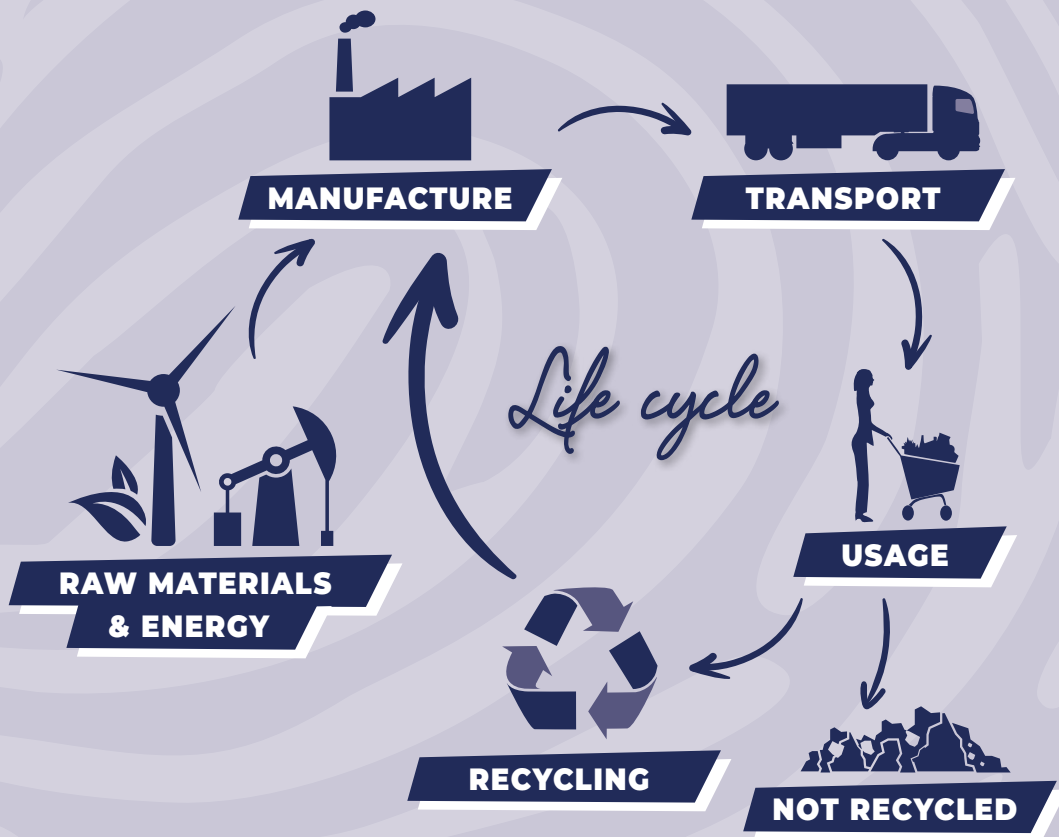

# General recommendations for installing OF AIR/WATER HEAT PUMP

## HYDRAULIC ACCESSORIES

### Disconnecter on water system

- The regulations require a type CA or BA disconnecter installed on a power system of less than 70 kW connected to the drinking water network, depending on the heat transfer fluid used.

### Safety valve

- The heat pump must be protected by at least one safety valve. It must be installed in an accessible place, in the immediate vicinity of the heat pump outlet pipe. There must be no isolating valves between the heat pump and safety valve.
- **Nota:** A safety valve is also necessary on the buffer tank, if equipped with a top-up electric heater.

### Safety thermostat on the heating floor outgoing line

- Installing a safety thermostat on the heating floor outgoing line is mandatory. It must have a manual reset, operate mechanically without an electrical supply, and be independent from the regulation system.
- It must cut the heating supply to avoid the temperature in the heating floor to exceed 55°C. In case of a temperature exceeding 55°C it must stop the heat pump and top-up electric heater, as well as the circulator, and close the three way regulation valve.

### Safety group

- The domestic hot water tank must be supplied in cold water via a safety group. There must be no branch connection or any elements between the safety unit and the water tank.

### Expansion tank

- The expansion tank must be preferably upstream of the circulator.

### Dirt separator and air bleed valve

- The installation must have a air bleed valve situated at the top point of the network. It is also advisable to equip the buffer tank. The automatic air bleed valve must be associated with an isolation valve.
- Dirt separator and sieve filter.
- It is highly recommended to install a dirt separator and filter sieve upstream of the heat pump, to protect it from sludging and maintain optimal heat exchange. The sieve filter must be at least equal in diameter to the circuit. Installing a drain valve is recommended, at the bottom of the buffer tank, so as to evacuate deposits.

### Pressure gauges on circulators

- The pressure gauge located on each circulator must be associated with two isolation valves. It measures the pressure in the circulator, and evaluates the flow based on the specific curve of the circulator.



**SNOWDRIFTS**

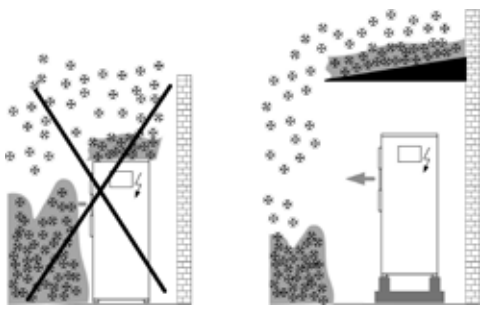

Provide a protection

**CONDENSATE DISCHARGE**

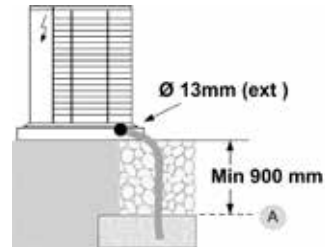

To avoid the water freezing downstream of the drain, lay the tube below the frost line (A).

**STRONG WINDS**

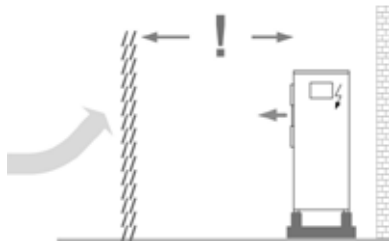

Provide windbreaks or similar

**WATER FEATURES**



< 15 °F. ?

If necessary, install water softener

**WATER FEATURES | DOMESTIC HOT WATER REQUIREMENTS**

The requirements vary by the number of people living in the building

\* Possibility of adding auxiliary cylinder in case of high hot water request



Estimated average daily per capita consumption of hot water

Requirements	Liters - day - people (bathroom)	Liters - day - people (kitchen)
Low	Min.15 > max. 30	Min. 10 > max. 20
<b>Medium</b>	Min.30 > max. 60	Min. 20 > max. 40
High	Min.60 > max. 120	Min. 40 > max. 80

Example: average requirement for 4 people need about 230 litres/day

**EXPANSION TANKS**

Litres ? °C ?



Sizing expansion tanks according to the system features

**ARTICLE 1 - PURPOSE AND SCOPE**

**1.1.** These general terms and conditions of sale apply to all sales of equipment and deliveries of services entered into by Groupe Airwell SA (hereinafter the "Vendor"), a public limited company (société anonyme) with a capital of 217 361 euros whose registered office is located at 10, rue du Fort de Saint Cyr, 78180 Montigny le Bretonneux, France, entered in the Versailles trade and companies register under number 752 800 862 from a professional buyer, understood as any natural or legal person, public or private, who acts for purposes within the framework of his commercial, industrial, craft, liberal or agricultural activity, including when they act in the name and on behalf of another professional. These general terms and conditions of sale are not applicable to a consumer or non-professional buyer.

**1.2.** "Equipment" refers to finished products, accessories, and spare parts.

**1.3.** Any order implies full and unconditional acceptance of these general terms and conditions of sale, which prevail over any other document of the buyer, particularly its general terms and conditions of purchase, unless otherwise expressly agreed beforehand by the Vendor.

**1.4.** If the Vendor does not invoke any clause within the general terms and conditions of sale at a given moment, this may not be interpreted as waiving its rights to invoke such clauses or these general terms and conditions of sale subsequently.

**ARTICLE 2 - GENERAL INFORMATION: CATALOGUES, DOCUMENTATION**

**2.1.** Due to the speed of technological developments and changes to standards or safety improvements in the sector concerned, any information, indication, or item of value transmitted on any medium, whether it comes from the manufacturer or the Vendor, is given for information purposes only. These parties reserve the right to make any modification to the equipment whose prints, photographs, or drawings appear in such documents, at any time and without notice. No document provided by the Vendor is to be considered as a contractual element, and the Vendor cannot be held liable for such documents.

**2.2.** Where the proposed equipment is selected by the Vendor on the basis of information provided by the informed professional buyer, the buyer is always responsible for ensuring that the characteristics of the equipment proposed by the Vendor are actually suitable for its needs, with regard to both performance and the possibilities of implementation. In addition, if the buyer resorts to hiring the Vendor's engineers or technicians for a study or project, the Vendor may not be held responsible, and the buyer undertakes to consult an expert in the field for, among other things, the selection and sizing of the equipment, as well as its installation and commissioning.

**2.3.** The buyer must not modify the markings affixed on the equipment or packaging, add any other marking, or use the Vendor's markings, names, or trademarks in any way not expressly authorized.

**ARTICLE 3 - ORDERS AND QUOTATIONS**

**3.1.** Orders are fixed. Once accepted, the order or quotation may only be modified or cancelled by the buyer with the Vendor's prior express consent. The buyer shall be liable for any order cancellation, even partial, and the Vendor shall be entitled to compensation in the form of a penalty set in the amount of the cancelled order, without prejudice to any other damages.

**3.2.** Any acceptance of an order or quotation must be written. Sales are final only after the express acceptance in the form of the Vendor issuing an acknowledgement of receipt of the buyer's order. The Vendor reserves the right to accept or reject any order within a maximum of five business days from its receipt.

**3.3.** The buyer must check the acknowledgement of receipt of the order, and report any error or omission to the Vendor within a maximum period of 48 hours from its receipt. Beyond this period, the order becomes final for the buyer. If a buyer places an order with the Vendor, without having paid for its previous order(s), the Vendor may refuse to fulfil the order and deliver the equipment in question, without the buyer being able to claim any compensation for any reason whatsoever.

**3.4.** The Vendor reserves the right, even after partial fulfilment of an order, to require guarantees or to cancel the order(s) or balance of orders in progress in the name of the buyer, without any kind of compensation, in the following cases: deterioration of the buyer's credit, failure to file documents and instruments with the registry of the commercial court, downgrading of the buyer's rating by the Vendor's credit department, refusal of a credit insurer or a factor to cover the amount of the sale, change or modification in the financial or legal capacity of the buyer, listings or liens on the buyer's business or in general, in case of a change in the buyer's situation.

**ARTICLE 4 - DELIVERY AND TRANSPORT**

**4.1.** Unless there are provisions or an agreement to the contrary, the transport/delivery costs are borne by the purchaser. The reference incoterms are FCA purchaser's warehouse or FOB port of shipment from the manufacturing plants.

**4.2.** The delivery lead times are given for information purposes only. In no case may exceeding the lead times justify the cancellation of the order or the awarding of damages. However, if the equipment still has not been delivered two months after a formal notice has remained unacted on, for any reason other than force majeure (as defined in article 6.2), the order may then be cancelled at the request of either party; the buyer may obtain a refund of its advance payment to the exclusion of any other compensation or damages.

**4.3.** In accordance with Article 133-3 of the French commercial code, any delivered equipment that was not the subject of reservations by registered letter with acknowledgement of receipt within three days of receipt (not including holidays) to the transporter, a copy of which shall be simultaneously sent to the Vendor, shall be considered accepted by the buyer.

**ARTICLE 5 - RECEIPT AND RETURN OF EQUIPMENT**

**5.1.** Complaints about apparent defects or the non-compliance of the delivered equipment must be expressed in detail on the delivery slip and by registered letter with acknowledgement of receipt, and sent to the Vendor's registered office within 72 hours after delivery. Beyond this period, the received equipment shall be considered compliant with the order. It shall be up to the buyer to provide, with its complaint, any justification as to the reality of the defects or anomalies observed. The buyer shall give the Vendor every opportunity to investigate such defects and find a solution.

**5.2.** In any case, the buyer may not return the equipment without authorization from the Vendor. The Vendor shall be responsible for the costs and risks of the return solely in the event that an apparent defect or missing items are actually noted by it or its representative. If a claim proves justified, the return shall be the subject of an exchange or a credit memo, at the Vendor's choice, without the ability to demand any compensation or damages in any capacity whatsoever. Any return of equipment previously accepted due to the buyer, including but not limited to an order error or incorrect information communicated for a calculation or an order made by the buyer, shall automatically result in a discount of 20% from the amount of the equipment in question excluding taxes, in order to take account of the costs of repackaging and any other charges, including transport, generated by this return. The buyer shall be responsible for the return transport.

**ARTICLE 6 - PRICE - PRICELIST AND PRICE REDUCTIONS**

**6.1.** Unless there are provisions or an agreement to the contrary, prices are set in euros excl. tax and FCA purchaser's warehouse for sales from the seller's stock, or FOB port of shipment from the manufacturing plants. For sales from manufacturing plants, a handling/freight/loading fee of 470 euros per container (regardless of container type) will be charged.

**6.2.** Equipment is sold based on the Vendor's pricelist still valid on the date of each placed order, or on the date of issue of each quote, subject to delivery occurring no later than the end of the second calendar month following that date. Beyond that period, any price change before delivery shall be automatically applicable.

**6.3.** No discount shall be applied by the Vendor for cash payment or for payment earlier than the period indicated in these general terms and conditions of sale, or on the invoice issued by the Vendor.



**6.4.** Unless otherwise agreed, the Vendor may grant the buyer discounts on the valid pricelist, including in the form of premiums, at the time when the order is placed, depending on the turnover excluding taxes generated annually or over a given period, and/or the quantity/nature of the purchased finished products and/or services possibly rendered by the buyer. These discounts may be fixed and/or gradual and may vary according to the buyer category.

**6.5.** If one of the criteria for application of these price reductions or any one of the clauses of these terms and conditions of sale is not met, the cancellation of such price reductions shall be immediately retroactive over the entire year in question. Consequently, if price reductions have already been applied by the Vendor during the year in question, they must be returned by the buyer on simple request.

#### **ARTICLE 7 - PAYMENT TERMS**

**7.1.** For any company based outside France, invoices shall be payable according to the payment period negotiated and agreed by the Vendor. For all French companies, invoices are payable within a maximum period of 45 days, end of month, or 60 days from the invoice issue date. For summarized invoices issued at the end of the month, the period must not exceed 45 days from the invoice issue date (article L. 441-6 of the Code of Commerce).

**7.2.** The Vendor reserves the right to require one or more advance payments when the order is placed and/or before shipment. Any commercial paper (bill of exchange or promissory note) presented for acceptance must be returned within eight clear days of its receipt by the buyer.

**7.3.** In accordance with Articles L. 441-3, L. 441-6, and D. 441-5 of the French commercial code, any payment delay automatically results in, in addition to late payment penalties at a rate equal to three times the statutory interest rate (i.e., 3.12% in the first half of 2022 updated each half-year period by the Minister of the Economy, with the understanding that this rate shall apply to the amount of the invoice including all taxes), an obligation for the debtor to pay 40 euros in recovery charges if the invoice has not been settled on the day following the payment date appearing on the invoice. In addition, in case of a late payment or a partial payment, (i) the Vendor may suspend all current and/or future orders; (ii) 48 hours after a formal notice has remained unacted on, the sale shall be automatically terminated, if so desired by the Vendor, which may move for summary proceedings for the return of the equipment, without prejudice to any other action and/or damages. The buyer must reimburse all costs caused by the non-payment (including return costs on unpaid debts) and the recovery of sums due, including fees of ministerial officers and/or recovery companies.

**7.4.** By no means may payments be suspended or offset without the Vendor's prior written approval. Any partial payment shall first be applied to the non-preferential part of the debt, then on the amounts with the earliest due date.

#### **ARTICLE 8 - RETENTION OF TITLE AND TRANSFER OF RISKS**

**8.1.** The transfer of ownership of the equipment is subject to the full payment of the price by the buyer. The buyer undertakes to maintain the equipment in good condition and insure it against all risks, for which the buyer shall be fully liable in all cases, as from their delivery. In order to permit any action for recovery by the Vendor, the buyer must ensure that the equipment can be individually identified.

**8.2.** The Vendor may recover its equipment regardless of whose possession it is in, in case of non-payment of the price by the buyer or insolvency thereof, even when such equipment has been handed over to a third party. If the equipment was resold, the buyer must notify the new buyer of the existence of the retention of title clause.

#### **ARTICLE 9 - LOCAL STANDARDS AND COMPLIANCE**

**9.1.** As concerns European countries subject to the FGAS EU517/2014 regulation, the importer of the products bears sole liability to the European authorities for the declaration of the FGAS quotas. Therefore, for orders from Airwell's central stock located in France, the FGAS quotas are declared by Airwell; no further action is to be taken by Airwell customers. For drop-shipped orders, imported directly from plants outside of Europe, the Airwell customer importing this order bears sole liability for the declaration of the FGAS quotas to the relevant authorities. The latter must complete the declaration paperwork in its own country. Airwell may, at the cus-

tomers request, sell and transfer FGAS quotas but Airwell shall not be held liable under any circumstances for a failure to declare quotas or any error in the quantities declared. The importing customer bears sole liability for the declaration of FGAS quotas.

**9.2.** Any entry of goods into the European Union or a third country is the sole responsibility of the importer. In this sense, the buyer is solely responsible for ensuring the conformity of the products it imports. Airwell cannot be held responsible if the products do not comply with the local standards when they enter the "destination" territory (release for consumption). The buyer must provide in advance all the documents necessary for the compliance of the imported products in the "destination" territory (release for consumption). Airwell strongly recommends a pre-departure inspection of the goods, at the customer's (buyer's) expense, to ensure the compliance of the imported goods. After research and analysis, Airwell reserves the right to refuse the order or to modify the pricing.

#### **ARTICLE 10 - ASSIGNMENT OF JURISDICTION - APPLICABLE LAW**

These general terms and conditions of sale are subject to French law. Any dispute shall be under the exclusive jurisdiction of the VERSAILLES COMMERCIAL COURT, even in case of interim proceedings, incidental claims, or multiple defendants or introduction of third parties.

#### **ARTICLE 11 - INTELLECTUAL PROPERTY**

**11.1.** The buyer is authorized, on a precarious basis, to use the brand, the commercial name, the sign, the graphic elements and other distinctive signs relating to the Vendor's equipment for the sole purpose of identifying and promoting them and in the exclusive interest of the Vendor. This right of use does not confer any ownership rights to the buyer. The buyer undertakes not to register and not to be the owner of trademarks, models, domain names, patents, signs, trade names, product references and other distinctive signs belonging to the Vendor (or of which it has the use) or which could lead to confusion with its own.

**11.2.** With regard to the Vendor's graphic elements, such as logos or photographs, the buyer undertakes to use and reproduce them only in strict compliance with the quality of the image and the format of the original graphic elements. The buyer shall not modify them or use them in such a way as to degrade the brand image of the Vendor or those image of the Vendor or of his equipment.

**11.3.** The buyer's right to use the Vendor's trademarks, trade names or other distinctive signs shall cease immediately when the business relationship with the Vendor ceases for any reason whatsoever. Same applies to non-compliance by the buyer with the conditions of use described in this article may result in the termination of this right of use at any time by simple letter.

#### **ARTICLE 12 - PRIVACY POLICY**

**12.1.** Any order for equipment implies the processing, by the Vendor, of personal data within the meaning of European Regulation 2016/679 of 27 April 2016 and Law No. 78-17 of 6 January 1978 relating to data processing, files and freedoms in its current version (hereinafter collectively the "Applicable Laws"), which relate to the buyer and/or the natural person, representative of the buyer, who places the order in the name and on behalf of the buyer.

**12.2.** The Vendor declares that it complies with the Applicable Laws and, in particular, implements the principles of personal data protection, notably the principles of lawfulness, proportionality, transparency and data minimization as set forth in the Applicable Laws.

**12.3.** The manner in which such data is collected and processed by the Vendor, as well as a description of the buyer's rights with respect to such data, are set out in the privacy policy adopted by the Vendor and available on its website at the URL <https://www.airwell.com/en/privacy-policy/>.

**12.4.** The Vendor's privacy policy is an integral part of these terms and conditions of sale.

THESE GENERAL TERMS AND CONDITIONS MAY BE SENT TO YOU IMMEDIATELY IN LARGE PRINT ON SIMPLE REQUEST. AS THESE TERMS AND CONDITIONS ARE ESSENTIAL TO THE VENDOR'S COMMITMENT, WE INVITE YOU TO CONTACT US IF THEIR READABILITY IS NOT SUITABLE FOR YOU.



## TECHNOLOGY



### FLEXY MATCH

Indoor units are compatible with monosplit or multisplit installation.



### DC INVERTER

Compressor with high efficiency DC engine.



### R410A FLUID

Refrigerant R410A.



### R32 FLUID

Refrigerant R32.



### R407C FLUID

Refrigerant R407C.



### R290 FLUID

Refrigerant R290.



### R134A R290 FLUID

Refrigerant R134A.



### ELECTRONIC EXPANSION VALVE

Precise control of refrigerant flow, optimized of performance and compressor protection.



### 4D AIRFLOW

Optimized heating and cooling operations, with an automatic horizontal and vertical swing.



### MULTIFLOW 360°

4-direction air distribution system with great comfort through 360°, with motorized opening control.



### GOLDEN FIN CONDENSER

Improve heat transfer efficiency and corrosion resistance.



### COMPATIBLE HYBRID HOUSE

Product compatible with the Hybrid House option.

## AIR QUALITY/CLEAN



### NANO PHOTOCATALYTIC FILTER

Oxidizes and degrades organic contaminants. It can eliminate up to 99.9% of bacteria and can efficiently at blocking dust.



### AIR FILTER

Eliminates fine particles and purifies the air.



### AUTO CLEAN/DRY

Prevents development of bacteria and moistures keeping the heat exchanger dry after a cooling operation.



### FRESH AIR

Cools the room by bringing fresh air from outside.

## USER FUNCTIONS



### I FEEL

Precise temperature control all around the chosen zone via a remote temperature sensor.



### NIGHT MODE

Temperature in the room adjusted based on sleeping habits.



### QUIET MODE

Top design for the lowest sound level.



### REFRIGERANT LEAKAGE DETECTOR

Indicates a refrigerant leakage on indoor unit and stops the system for compressor protection.



### PROGRAMMABLE TIMER

Timer set to switch the unit on and off.



### TIMER

Timer for switching the appliance on or off.



### AUTO RESTART (MEMORY)

Automatically restarts the unit in the last used mode when power is restored.



### REMOTE CONTROL LOCK

Locks the remote functions to avoid inadvertent actions.



### Wi-Fi

Air conditioner controlled via mobile phone, tablet or computer through a wireless router and internet, thanks to AirHome app.



### REDUNDANCY FUNCTION

Product compatible with Airwell redundancy solution.

## INSTALLER FUNCTIONS



### ERROR CODE VIA INDOOR UNIT

Digital display of error codes or temperature settings on the indoor unit.



### AUTO-DIAGNOSTIC

Unit failure indicated by a blinking led on the unit display.



### BUILT-IN CONDENSATE PUMP

Eliminates condensate, for a simple and smooth running.



### LEFT/RIGHT DRAIN CONNECTION

Easy-to-install condensate tubing, either on the left or right side.



### ALARM OUTPUT

Remote transmission of malfunctions.



### DRY CONTACT ON/OFF

Connection to a detection accessory (room card, presence detection, window...) to make energy savings.



### BMS COMPATIBLE

Connection to the BMS system.



### SERVICE MONITOR TOOL

Local interface for monitoring the operating parameters.



### POWER CONSUMPTION CONTROL

Energy consumption control reducing the unit's energy consumption.



### OUTDOOR UNIT NIGHT MODE DRY CONTACT

Outdoor unit speed limitation and noise level reduction.



### OUTDOOR UNIT STAND-BY

Power on or power off of the outdoor unit from the remote.



### OUTDOOR UNIT ALARM OUTPUT

Transmission of an air output fault alarm to a remote system.



### TECHNICIAN TEST MODE

Special mode optimizing the technician's intervention time.



### HEATING MODE ONLY

The unit can be configured in heating only mode.



### AUXILIARY HEATER

Relaunches the heating capacity when the systems runs at a very low ambient temperature.

## HEATING RANGE



### WEEKLY TIMER

Program a scenario that will be automatically executed by the device on a weekly basis.



### UNIT ON/OFF OUTPUT

Option displaying the unit's power status on the remote control.



### COOLING MODE OPERATIONAL UP TO 43°/46°C OUTDOORS

Operation in cooling mode even at very high outside temperature, thanks to the special design of the unit.



### HEATING MODE OPERATIONAL DOWN TO -20°/-25°C OUTDOORS

Heating mode available even at very low outdoor temperatures, thanks to the special design of the unit.



### HIGH TEMPERATURE UP TO 55°/60°C

High temperature production up to 60°C.



### DOMESTIC HOT WATER

Production of domestic hot water.



### FLOOR HEATING

Connection available with a low-temperature transmitter.



### HIGH-TEMPERATURE RADIATOR

Connection available with a high-temperature transmitter.



### LOW-TEMPERATURE RADIATOR

Connection available with a low-temperature transmitter.



### BOILER REPLACEMENT

Replace an old, energy-consuming boiler with an efficient Airwell heat pump.



### BOILER BACK-UP

Complement a boiler with a heat pump.



### WATER PROGRAMS

The regulator maintains the heat pump power in accordance with a water logic based on outdoor temperature.



### CEE

The product is CEE certified.



### RENEWABLE ENERGY

The product is compatible with renewable energy standard.



### KEYMARK CERTIFICATION

The product is Keymark certified.

AS PART OF ITS INVOLVEMENT IN THE  
**ENERGY TRANSITION**  
AIRWELL HAS IMPLEMENTED THE

## *Airwell* ACADEMY

### TECHNICAL & QUALIFICATION TRAINING

to allow maintenance technicians, installers and distributors to develop their knowledge and offer them an energy management system that is both essential for their activity but also for the planet!



Read more about training at:  
[www.airwell-academy.fr](http://www.airwell-academy.fr)

AFTER-SALES  
SERVICE

**+33 (0)1 76 21 82 95**

Monday to Friday 9 am-12:30 pm / 2 pm-5 pm

**TECHNICAL SUPPORT**

[sav@airwell.com](mailto:sav@airwell.com)

## GROUPE AIRWELL

10, rue du fort de Saint Cyr - 78180 Montigny-le-Bretonneux, FRANCE

Tél.: +33 (0)1 76 21 82 00 - [www.airwell.com](http://www.airwell.com)

Printed in France